

AOM Driver MHPXXX-YYADM-A1 (Formerly N31xxx-yyADM) (24 to 260MHz, 2 to 20W)

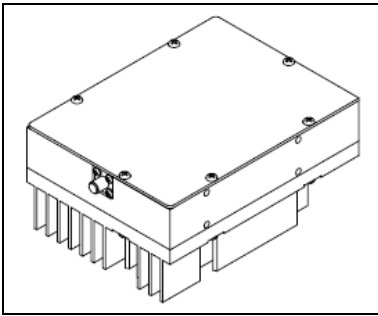

The MHPxxx-yyADM-A1 driver is a RF driver module with analog and digital modulation input and up to 20 Watts Output into a 50 Ohm load. The model number is described as follows:

xxx = a fixed frequency of between 24 and 260 MHz crystal controlled.

yy = 2 to 20W nominal. Set by internal pot

A = Analog Modulation

D = Digital Modulation

M = OEM Module

Output Frequency (xxx)	24 MHz to 260 MHz $\pm 0.01\%$ quartz stabilized
Spurious Levels	-40 dBc maximum
Harmonic Distortion	-15 dBc maximum
Analog Input	0-1 Volt into 50 Ohms (+ 1 Volt = Full RF power; 0 Volt = minimum RF power)
Digital Input	TTL Levels (TTL HIGH = FULL RF power; TTL LOW = minimum RF power)
Extinction Ratio	40 dB minimum
RF Rise/ Fall Time	30ns maximum, 20 ns typical, 10ns > 210MHz (P_{RF} : 10 to 90%)
RF Output Power (yy)	2 to 20 Watts nominal. maximum output power set by internal pot.
Output Impedance	50 Ohms nominal
Supply Voltage	+ 24 VDC + 0.5 Volt
Supply Current	3 Amp maximum
Air Flow Across heat sink	18 CFM at 25 °C
MAXIMUM RATINGS	
Supply Voltage	+ 28 Volts
Power Output	No DC feedback allowed
Case Temperature	+ 55°C.
CONNECTORS & MECHANICAL	
RF Output Connector	BNC female
Modulation Input Connector	Feed Through Pin
Power Supply Connections	Vcc: Vcc feed through Pin; Return: Feed through Pin
Physical Size	5.43" L x 2.42" H x 3.90" W

NOTES: UNLESS OTHERWISE SPECIFIED
 1. DRAWING PREPARED IN ACCORDANCE WITH MIL-STD-100.
 2. DIMENSIONING AND SYMBOLS PER ASME Y14.5M-1982.
 3. INTERPRET 3RD ANGLE PROJECTION.
 ⌀ (ISO-A).
 ⚠ SEE CHART FOR SPECIFIC MODEL AND AVAILABLE CONNECTIONS.

MHPXXX-YYADM-A1
 (Formerly N31xxx-yyADM)
 (24 to 260MHz, 2 to 20W)

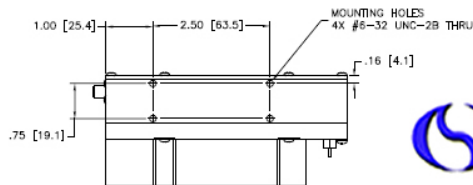
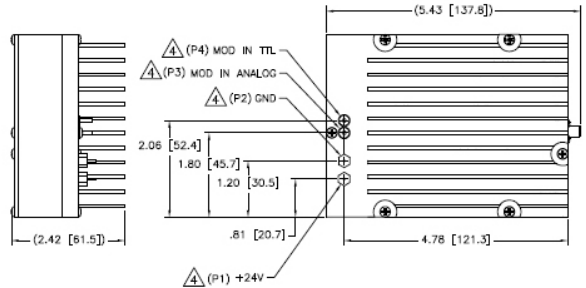
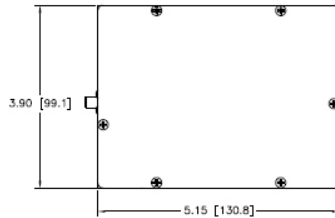
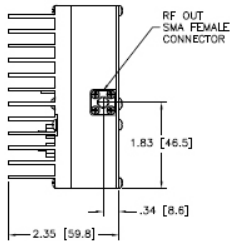
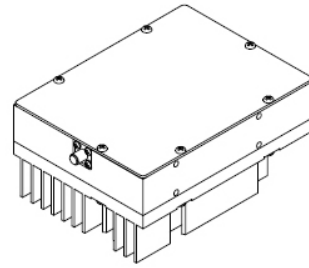
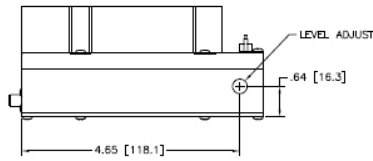

MODEL	AVAILABLE CONNECTIONS			
	P1	P2	P3	P4
31XXX-XDM-	X	X		X
31XXX-XAM-	X	X	X	
31XXX-XADM-	X	X	X	X

 **Sintec Optronics Pte Ltd**
 E-mail: sales@sintec.sg
 URL: <http://www.sintec.sg>