

STFE Series Frequency Converters

Our frequency converter is an ultra compact platform that converts your femtosecond low-energy IR laser pulses (nJ-range) into 2nd and 4th harmonics with best-in-class conversion efficiency. Its industrial-grade design, makes it a robust and reliable solution that will extend the capabilities of your laser. The design is easily adaptable to higher pulse energies, up to μJ or mJ level.

Key features

- Ultra compact, industrial-grade platform : sealed, nitrogen purged
- High conversion efficiency of low-energy pulses (nJ level)
- Wavelength change from 3 outputs, within seconds : fundamental, 2nd and 4th harmonics
- All-in-one design. Laser and conversion unit are combined into one single robust assembly
- Alignment free. No software needed



	1064 nm	532 nm		266 nm
Power	2 W	1 W *	750 mW *	170 mW
Repetition rate	80 MHz			
Conversion efficiency		> 45%	> 35%	> 8%
Pulse duration	< 120 fs	< 120 fs	< 65 fs	< 60 fs (estimated)
Polarization	vertical	horizontal	vertical	
Dimension	151x33x52mm			

* Laser operation mode can be switched between long/short pulse, leading to two different output power at 532 nm This table shows an example of typical performance for a specific laser. For a different laser type and/or different specifications, It will be adapted by our team for best conversion efficiency.

Integration:

You can use the frequency conversion module with any laser with 1030 - 1064 wavelength, nanojoule energy and megahertz repetition rate. We also can provide breadboards for an easier integration.

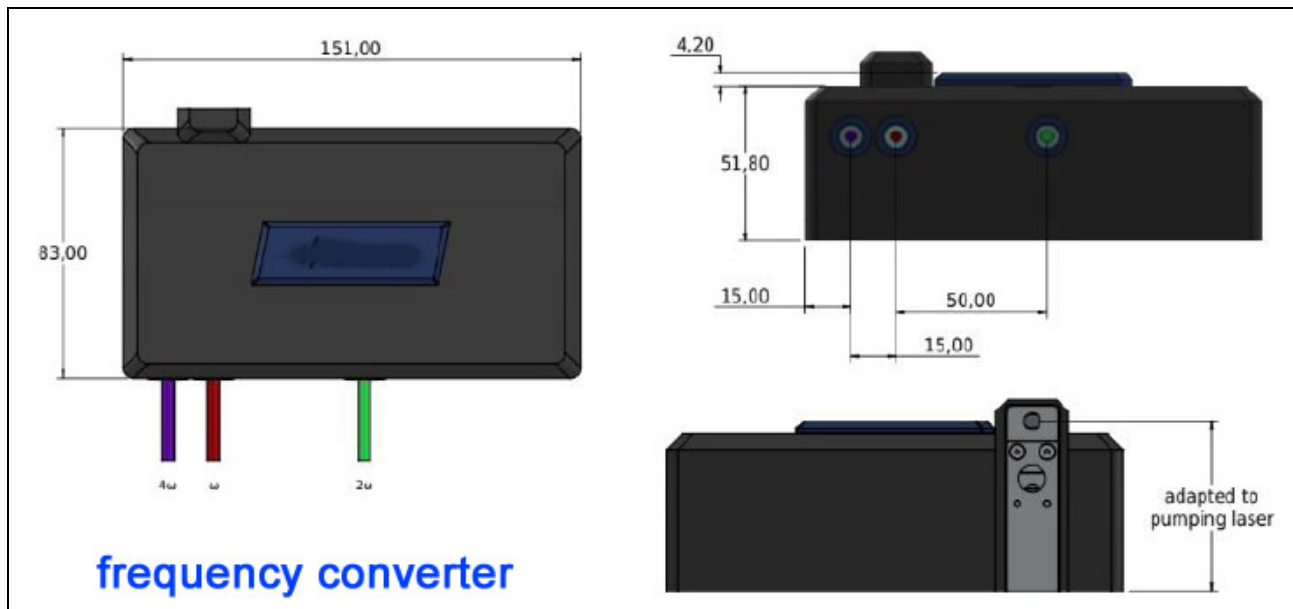

MgO:PPLN for Efficient Wavelength Conversion

Adding 5% magnesium-oxide to lithium niobate significantly increases the optical and photorefractive resistance of the crystal while preserving its high nonlinear coefficient. This allows more stable operation at visible wavelengths and lower temperature operation than a similar undoped crystal. MgO:PPLN can be operated at temperatures as low as room temperature and in some cases, without temperature stabilisation. With temperatures from ambient up to 200°C, MgO:PPLN offers significantly wider wavelength operation than undoped PPLN.

Specially developed for red-green-blue generation and high power mid-IR operation, our proprietary MgO:PPLN poling process offers high fidelity periods from 4.5µm to 33µm+ and is ideal for volume manufacture. As shown below, our MgO:PPLN domains are poled through the entire thickness of the sample, providing maximum optical aperture.



Our MgO:PPLN crystals are designed to work with a wide range of common laser wavelengths. Each off-the-shelf device includes multiple gratings for flexible temperature and wavelength operation. MgO:PPLN has a wide operating temperature range from 30-200°C.

Crystal lengths are 0.3mm to 1mm for short-pulse femtosecond lasers and 10mm to 40mm for ns to CW systems. Our standard crystals are supplied clip-mounted and off-the-shelf. Custom crystal lengths, thicknesses, AR coatings, and grating designs are also available upon request.



1, 10, 20 & 40mm clip-mounted MgO:PPLN

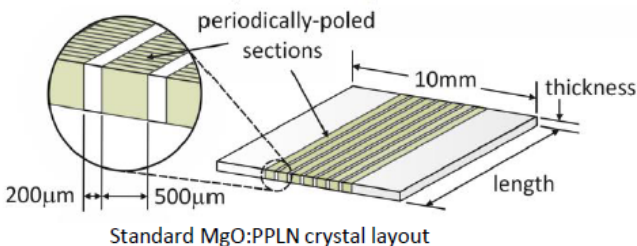

- Multi-band AR coated
- Flatness <math><\lambda/4@633\text{nm}</math>
- Parallel to ± 5 minutes
- Better than 70:30 mark-to-space ratio
- Polished to 20-10 scratch dig
- Fewer than two 100µm edge chips per facet

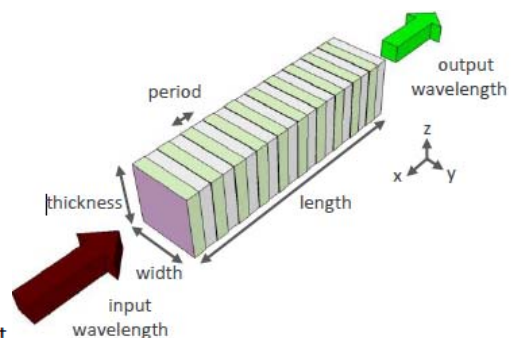

Pictorial representation of a PPLN grating where laser light focused into the grating is converted to another wavelength. This can be achieved with the correct poling period, crystal temperature, and z-axis polarization.

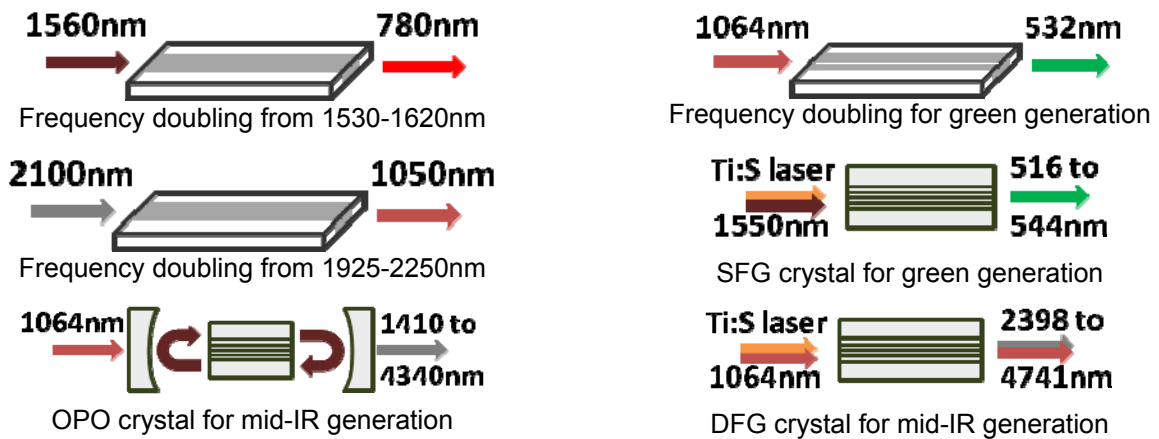

MgO:PPLN for SHG: visible and near-IR wavelengths

Second Harmonic Generation:

- High efficiency frequency doubling of IR lasers to visible and shorter near-IR wavelengths
- Available in 0.5mm and 1.0mm apertures
- Mounted and double-band AR coated

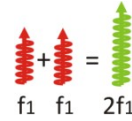

Applications:

- Green and blue generation
- Scientific & medical
- Frequency comb stability
- Fluorescence microscopy

Our SHG MgO:PPLN crystals are designed to work with a wide range of common laser wavelengths. Each device has several gratings to allow phase matching at different temperatures. The visible wavelength devices contain multiple gratings designed for phase matching of the nominal pump wavelength typically between 30-200°C. Tuning to temperatures up to 200°C allows phase matching to longer wavelengths. All of our products undergo rigorous quality inspection and are supplied clip-mounted and off-the-shelf. Custom crystal lengths, thicknesses, AR coatings, and grating designs are also available upon request.

Calculated temperature vs. phase matching wavelength tuning curve of MSHG1064

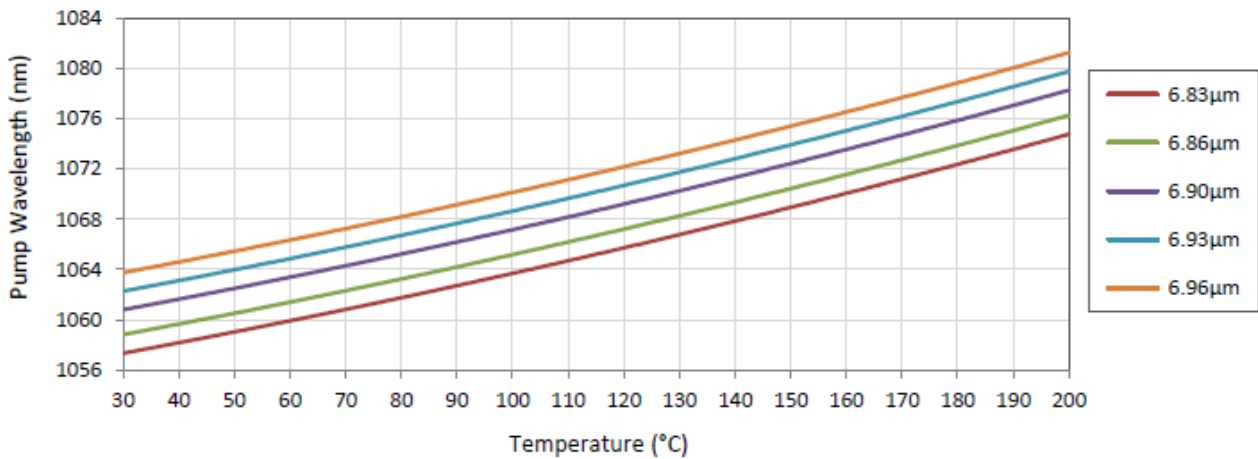

Calculated temperature vs. phase matching wavelength tuning curve of MSHG1550-0.5

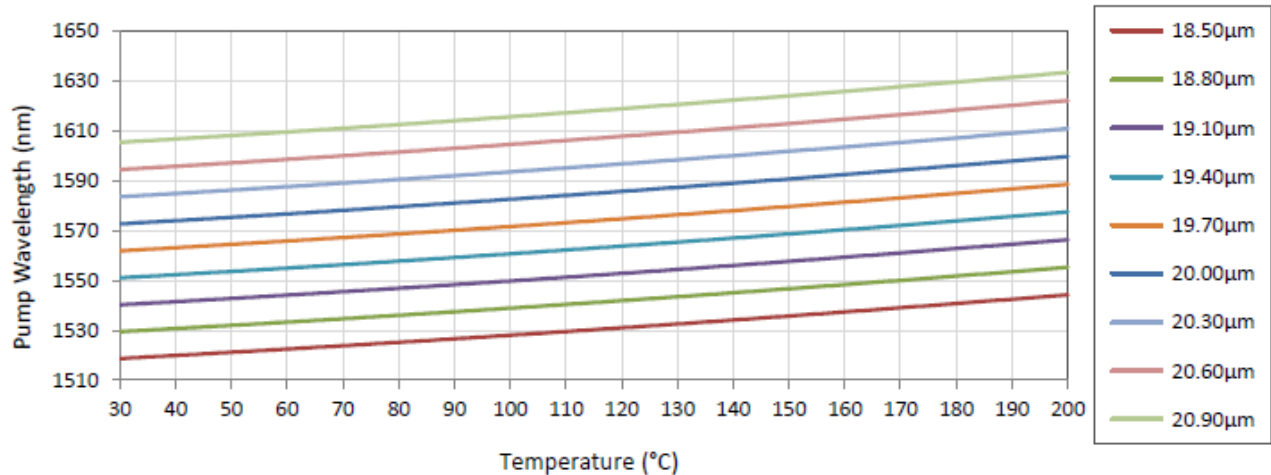

part #	pump (nm)	output (nm)	grating periods (μm)	temperature tuning range (°C)	thickness (mm)	standard* lengths (mm)
STCS-MSHG976-0.5	976 (970 – 992)	488 (485 – 496)	5.17, 5.20, 5.23, 5.26, 5.29	30 – 200	0.5	1, 3, 5, 10, 20
STCS-MSHG1020-1.0	1020 (1006-1036)	510 (503-518)	5.84, 5.98, 6.08	30 – 200	1.0	1, 3, 5, 10, 20, 40
STCS-MSHG1030-0.5	1030 (1024 – 1047)	515 (512 – 524)	6.16, 6.19, 6.23, 6.26, 6.29	30 – 200	0.5	1, 3, 5, 10, 20, 40
STCS-MSHG1047-0.5	1047 (1040 – 1064)	523.5 (520 – 532)	6.48, 6.52, 6.55, 6.59, 6.62	30 – 200	0.5	1, 3, 5, 10, 20, 40
STCS-MSHG1064-0.5	1064 (1058 – 1080)	532 (529 – 540)	6.83, 6.86, 6.90, 6.93, 6.96	30 – 200	0.5	1, 3, 5, 10, 20, 40
STCS-MSHG1064-1.0	1064 (1058 – 1080)	532 (529 – 540)	6.83, 6.86, 6.90, 6.93, 6.96	30 – 200	1.0	1, 3, 5, 10, 20, 40
STCS-MSHG1080-0.5	1080 (1060-1116)	540 (530-558)	6.90, 7.10, 7.30, 7.50, 7.70	30 – 200	0.5	1, 3, 5, 10, 20, 40
STCS-MSHG1120-1.0	1120 (1106-1158)	560 (553-579)	7.87, 7.99, 8.11, 8.23, 8.35, 8.47, 8.59	30 – 200	1.0	1, 3, 5, 10, 20, 40
STCS-MSHG1180-0.5	1180 (1166-1220)	590 (583-610)	9.20, 9.40, 9.60, 9.80, 10.00	30 – 200	0.5	1, 3, 5, 10, 20, 40
STCS-MSHG1230-0.5	1230 (1216-1262)	615 (608-631)	10.40, 10.55, 10.70, 10.85, 11.00	30 – 200	0.5	1, 3, 5, 10, 20, 40
STCS-MSHG1320-0.5	1320 (1284-1336)	660 (642-668)	12.10, 12.30, 12.50, 12.70, 12.90	30 – 200	0.5	1, 3, 5, 10, 20, 40
STCS-MSHG1350-0.5	1350 (1296-1422)	675 (648-711)	12.40, 12.80, 13.20, 13.60, 14.00, 14.40, 14.80, 15.20	30 – 200	0.5	1, 3, 5, 10, 20, 40
STCS-MSHG1420-0.5	1420 (1350-1490)	710 (675-745)	13.83, 13.96, 14.08, 14.55, 15.10, 15.60, 16.10, 16.60, 17.10	30 – 200	0.5	1, 3, 5, 10, 20, 40
STCS-MSHG1550-0.5	1550 (1530 – 1620)	775 (765 – 810)	18.50, 18.80, 19.10, 19.40, 19.70, 20.00, 20.30, 20.60, 20.90	30 – 200	0.5	0.3, 0.5, 1, 3, 5, 10, 20, 40
STCS-MSHG1550-1.0	1550 (1545 – 1610)	775 (773 – 805)	19.20, 19.50, 19.80, 20.10, 20.40	30 – 200	1.0	1, 3, 5, 10, 20, 40
STCS-MSHG1650-0.5	1650 (1605 – 1720)	825 (803 – 860)	20.90, 21.20, 21.50, 21.80, 22.10, 22.40, 22.70, 23.00, 23.30	30 – 200	0.5	1, 3, 5, 10, 20, 40
STCS-MSHG2100-0.5	2100 (1925-2270)	1050 (963-1135)	28.40, 29.00, 29.60, 30.20, 30.80, 31.40, 32.00, 32.60, 33.20	30 – 200	0.5	1, 3, 5, 10, 20, 40
STCS-MSHG2100-1.0	2100 (1968-2270)	1050 (984-1135)	29.60, 30.20, 30.80, 31.40, 32.00, 32.60, 33.20	30 – 200	1.0	1, 3, 5, 10, 20, 40
STCS-MSHG2600-1.0	2600 (2260-3300)	1300 (1130-1650)	34.00, 34.80, 35.50, 35.80, 35.97	30 – 200	1.0	1, 3, 5, 10, 20, 40

**custom crystal lengths from 0.3mm to 50mm available upon request*

MgO:PPLN for OPO, DFG and SFG

The wide transmission range and non-critical walk-off angle of MgO:PPLN make this material ideal for generating wavelengths throughout the mid-IR.

Based on our standard design layout, our MgO:PPLN OPO (optical parametric oscillator), DFG (difference frequency generation) and SFG (sum frequency generation) crystals are designed to work with common pump wavelengths at 1064nm, tunable 775nm and 1550nm. Our OPO and DFG crystals cover a broad continuous tuning range from the near-IR to beyond 4.5 μ m in the mid-IR, whilst our SFG crystals are designed for tunable green generation.

Our crystals undergo quality inspection and are supplied off-the-shelf. Our crystals are AR coated and clip-mounted, ready for use with our ovens and controller.

Optical Parametric Oscillation / Generation:

- Widely tunable mid-IR from a 1064nm pump source
- Also suitable for DFG
- Temperature tuning from 30-200°C
- Available in 0.5mm and 1.0mm apertures
- Mounted and triple-band AR coated

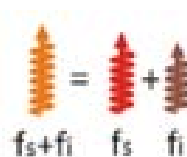

Applications:

- Mid-IR spectroscopy
- Environmental monitoring
- LIDAR & laser counter measures

part #	pump (nm)	signal (nm)	idler (nm)	grating periods (μ m)	thickness (mm)	standard* lengths (mm)
STCS-MOPO515-0.5	515	640 – 1030	1030 – 2530	6.00, 6.26, 6.53, 6.81, 7.10, 7.40, 7.71, 8.03, 8.36	0.5	1, 3, 5, 10, 20, 40
STCS-MOPO1-0.5	1064	1410 – 2128	2128 – 4340	27.91, 28.28, 28.67, 29.08, 29.52, 29.98, 30.49, 31.02, 31.59	0.5	1, 3, 5, 10, 20, 40
STCS-MOPO1-1.0	1064	1480 – 2128	2128 – 3785	29.52, 29.98, 30.49, 31.02, 31.59	1.0	1, 3, 5, 10, 20, 40
STCS-MOPO2-1.0	1064	1342 – 1460	3945 – 5135	25.5, 26.0, 26.5, 27.0, 27.5, 28.0, 28.5	1.0	1, 3, 5, 10, 20, 40, 50
STCS-MOPO3-1.0	1064	1430 – 2085	2085 – 4185	28.5, 29.0, 29.5, 30.0, 30.5, 31.0, 31.7	1.0	1, 3, 5, 10, 20, 40, 50

**custom crystal lengths from 0.3mm to 50mm available upon request*

Difference Frequency Generation:

- Temperature tuning 30-200°C
- Available in 0.5mm and 1.0mm apertures
- Mounted and triple-band AR coated

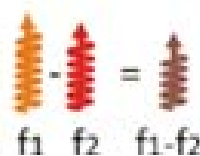

Applications:

- Mid-IR spectroscopy
- Environmental monitoring
- LIDAR & laser counter measures

part #	pumps (nm)	output (nm)	grating periods (μm)	thickness (mm)	standard* lengths (mm)
STCS-MDFG1-0.5	737 – 786 & 1064	2398 – 3008	18.50, 18.80, 19.10, 19.40, 19.70, 20.00, 20.30, 20.60, 20.90	0.5	1, 3, 5, 10, 20, 40
STCS-MDFG2-0.5	775 – 869 & 1064	2853 – 4741	20.90, 21.20, 21.50, 21.80, 22.10, 22.40, 22.70, 23.00, 23.30	0.5	1, 3, 5, 10, 20, 40
STCS-MDFG3-1.0	1480 – 2128 & 1064	2128 – 3785	29.52, 29.98, 30.49, 31.02, 31.59	1.0	1, 3, 5, 10, 20, 40
STCS-MDFG4-0.5	885 – 1210 & 1550	2063 – 5516	24.06, 24.63, 25.23, 25.86, 26.53, 27.22, 27.96, 28.74, 29.56, 30.43, 31.35, 32.33, 33.37, 34.48, 35.67, 36.95	0.5	1, 3, 5, 10, 20, 40

**custom crystal lengths from 0.3mm to 50mm available upon request*

Sum Frequency Generation:

- Combines fixed 1550nm and tunable 780nm or 810nm pump sources to provide tunable green wavelengths
- 0.5mm apertures
- Mounted and triple-band coated

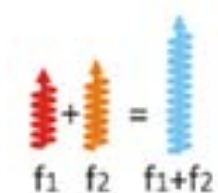

Applications:

- Cascaded THG from 1550nm
- Quantum optics

part #	pump (nm)	output (nm)	grating periods (μm)	thickness (mm)	standard lengths* (mm)
STCS-MSFG1-0.5	775 – 840 & 1550	516 – 544	6.90, 7.10, 7.30, 7.50, 7.70	0.5	1, 3, 5, 10, 20, 40
STCS-MSFG578-0.5	1280 – 1365 & 1030	570 – 587	8.70, 8.80, 8.90, 9.00, 9.10	0.5	1, 3, 5, 10, 20, 40
STCS-MSFG612-0.5	1000 – 1025 & 1550	608 – 617	10.40, 10.55, 10.70, 10.85, 11.00	0.5	1, 3, 5, 10, 20, 40
STCS-MSFG626-0.5	1550 – 1560 & 1051	618 – 628	11.12, 11.17, 11.22	0.5	1, 3, 5, 10, 20, 40
STCS-MSFG637-0.5	1520 – 1590 & 1070	628 – 640	11.60, 11.65, 11.70, 11.75, 11.80	0.5	1, 3, 5, 10, 20, 40
STCS-MSFG647-0.5	1085 – 1160 & 1550	638 – 663	12.10, 12.30, 12.50, 12.70, 12.90	0.5	1, 3, 5, 10, 20, 40

**custom crystal lengths from 0.3mm to 50mm available upon request*

Calculated temperature vs. phase matching wavelength tuning curve of MSFG1 with 1550nm pump

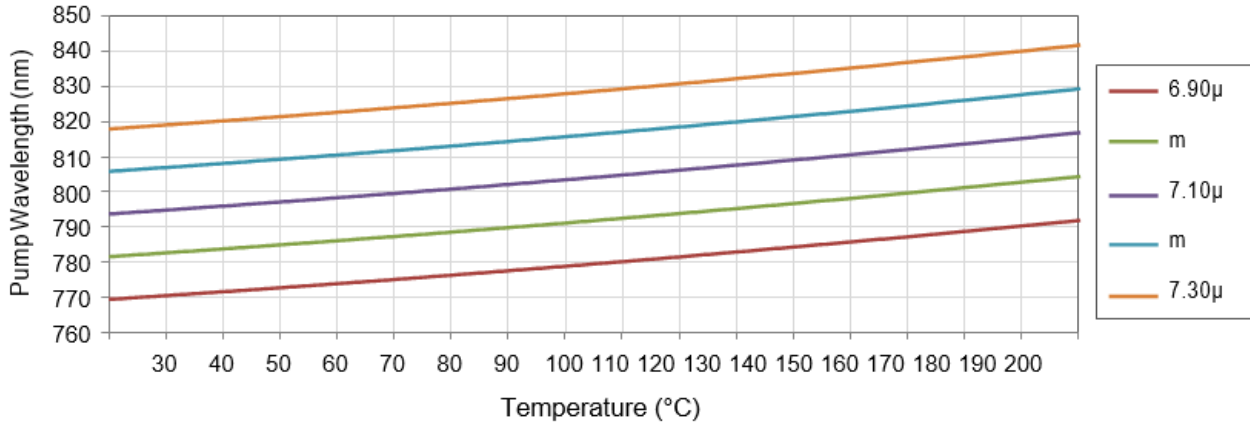

Calculated temperature vs. phase matching wavelength tuning curve of MSFG626 with 1051nm pump

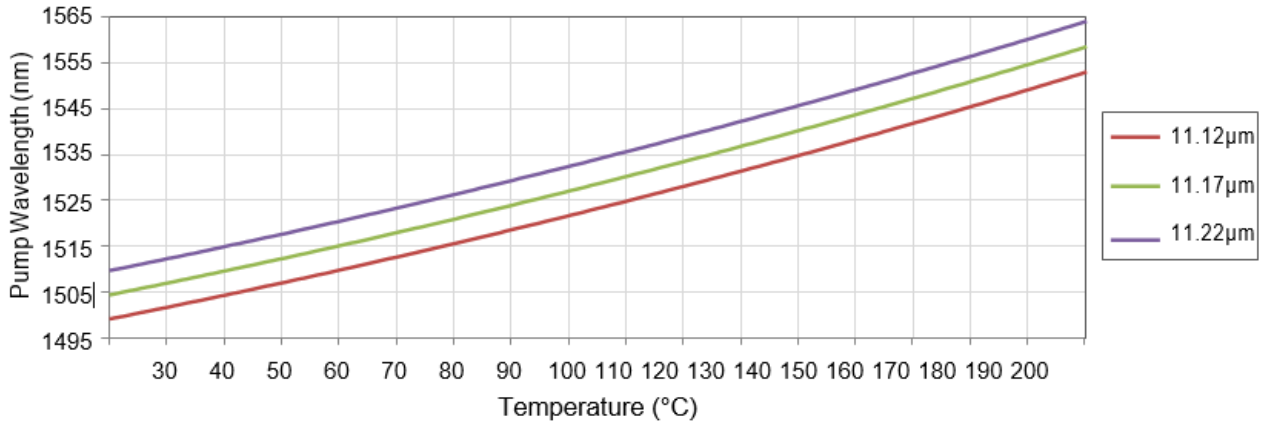

Custom MgO:PPLN for R&D to high-volume OEM

We provide a versatile basis for the design and manufacture of unique PPLN crystals. Our custom design and fabrication service provides application-specific technical consultation with specialist grating design and contract manufacture, resulting in a wavelength conversion solution tailored to your target laser system. We offer a range of custom design packages including:

- one-off crystals
- OEM prototyping
- Large-volume manufacture

If our stock crystals do not meet your requirements, our engineering team is available to find the best crystal solution for your interaction. Our custom fabrication service involves consultation with the customer for design of the full grating layout, mask design, wafer poling, dicing, polishing and AR coating.

Your custom crystal can be designed to have a standard multi-grating layout, so that you can continue to use our temperature control systems, or your own unique design that is customised to your OEM laser system.

We can manufacture single crystals as small as $<1\text{mm}^3$ for compact intra-cavity designs, or several millimetres wide aperture gratings with a long crystal length for high power applications.

Custom Designs for Non-standard Interactions:

PPLN crystals can be designed with aperiodic grating patterns to enable tailored spectral or thermal performance.

Periodic Custom designs:

- Specific poling periods with custom AR coating
- Specific poling periods with wider aperture
- Non-standard length and custom aperture angles

Aperiodic Custom designs:

- Linear period chirped gratings
- Non-linear period chirped gratings

Please contact our design team to discuss your custom grating requirement.

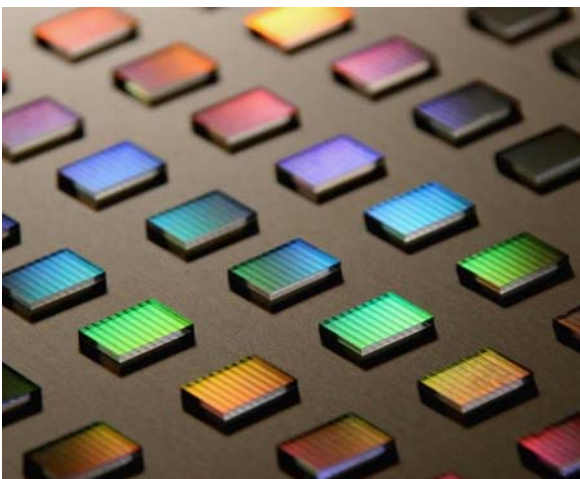

MgO:PPLN crystals

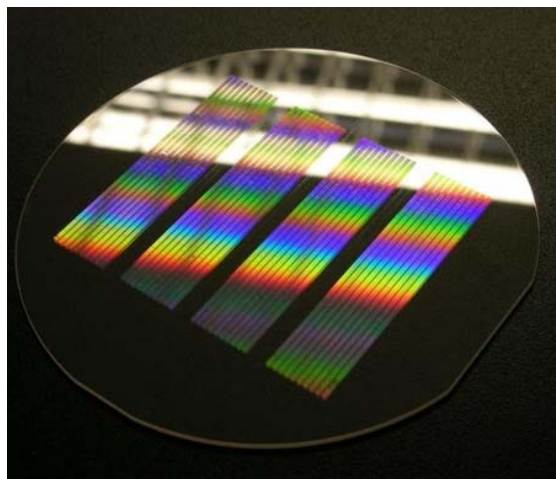

Custom MgO:PPLN wafer

MgO:PPLN Applications

Chemical fingerprints can be identified for homeland security applications. PPLN devices are designed for efficient frequency conversion of lasers allowing you to reach wavelengths that cannot be achieved with conventional solid state lasers, diode lasers etc.

For example, you can use PPLN to:

- frequency double a 1064nm laser to 532nm, a technique used for green laser pointers
- convert 1064nm to 3 μ m, used for gas detection or microscopy imaging techniques
- generate a narrow linewidth laser source for targeting a specific atomic transition for laser cooling and trapping.

Alternatively, PPLN has often been used to frequency double a high power tuneable 1550nm fibre source as a low cost and compact alternative to the Ti:Sapphire laser. Such a source can be used in microscopy systems for live-cell imaging, or terahertz time-domain spectroscopy where

PPLN devices are commonly used for high power mid-IR generation in an optical parametric oscillator. Tunable mid-IR systems are used in a wide range of microscopy imaging techniques as well as spectroscopy applications for environmental imaging. With pulse energies in excess of 1mJ, these mid-IR sources are also used in the defence industry for laser countermeasures and LIDAR systems.

Our MgO:PPLN has a wide range of applications:

Femtosecond Lasers

- THz generation
- Metrology
- Frequency comb stabilization

Green Lasers

- Laser projectors
- Seabed surveying

Bio-Photonics

- CARS microscopy
- Fluorescence-based microscopy
- DNA sequencing

Quantum Optics

- Quantum computing
- Precision navigation systems

Defence

- Laser countermeasures
- Trace gas detection LIDAR

Aerospace

- Environmental monitoring
- Remote sensing Interferometry

Examples:

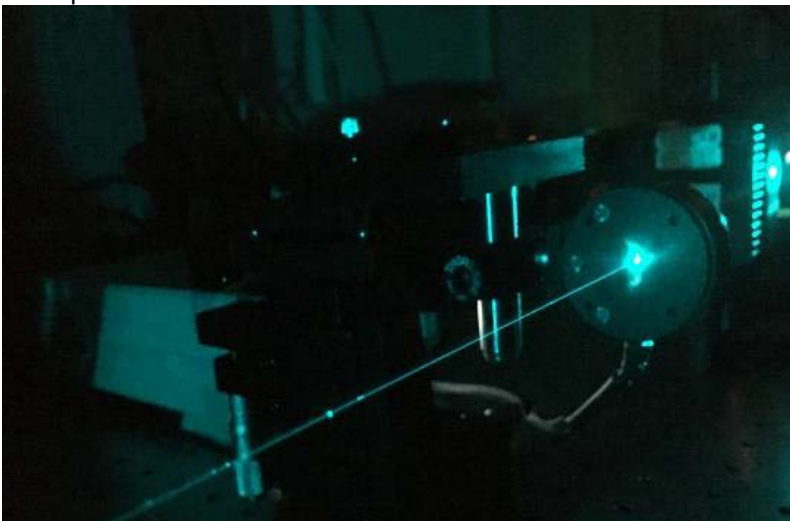

Picosecond cascaded frequency doubling with two crystals from 1952nm to 488nm. *By Lin Xu, ORC, Uni. Of Southampton*

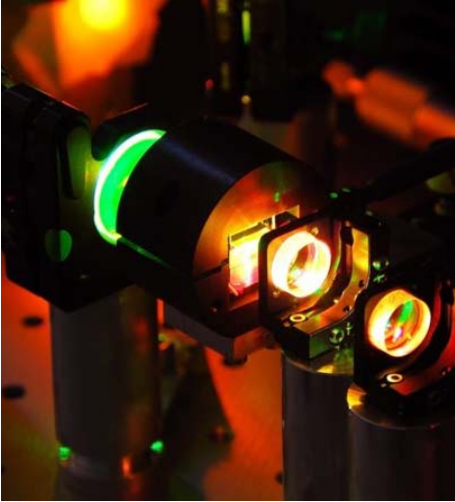

Nanosecond optical parametric oscillator for mid-IR generation Image courtesy of Elforlight 1952nm to 488nm By Lin Xu, ORC, Uni. Of Southampton

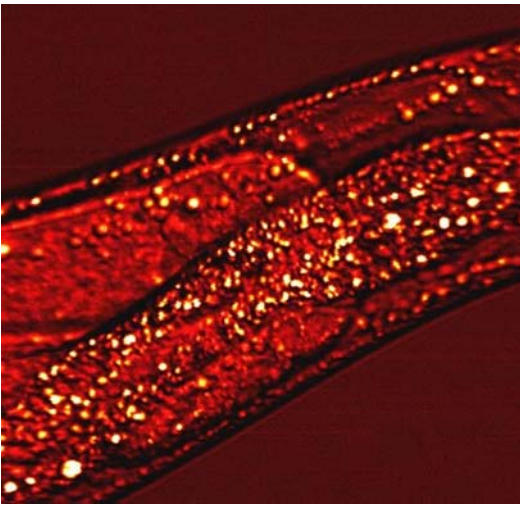

CARS microscopy image of elegans worm

PPLN ovens, temperature controllers and accessories

Our optical engineers have designed a range of PPLN crystal clips, ovens, temperature controllers and mounting accessories, providing a complete PPLN system for easy integration into your optical arrangement.

Our PPLN clips are easily mounted into the oven using the auto-locating pins. These also allow the PPLN clips to be swapped in and out with negligible realignment of the optical train.

Several sprung pins in the oven top hold the PPLN crystal clip securely in place. The oven and PPLN crystal can then be mounted in any orientation, flexible to your choice of optical arrangement.

We recommend the OC2 temperature controller for high thermal PV oven series. The PV Oven Series is specially designed to provide secure mounting and robust thermal stability for our PPLN crystals.

Key Features:

- Auto-locating dowel pins for alignment-free insertion
- Temperature stability of $\pm 0.01^{\circ}\text{C}$ with OC2 controller
- Various mounting options available

Part number	Crystal length	Oven length	PPLN clip
STCS-PV10	1mm, 10mm	22mm	PC1, PC10
STCS-PV20	20mm	32mm	PC20
STCS-PV40	40mm	53mm	PC40
STCS-PV50	50mm	62mm	PC50

PPLN clip kits:

The PPLN Clip Kits provide secure mounting of our PPLN crystals. All our crystals are supplied clip-mounted and ready for use in our ovens.

part #	crystal length	oven length	PPLN clip
STCS-PV10	1mm, 10mm	22mm	PC1, PC10
STCS-PV20	20mm	32mm	PC20
STCS-PV40	40mm	52mm	PC40
STCS-PV50	50mm	62mm	PC50

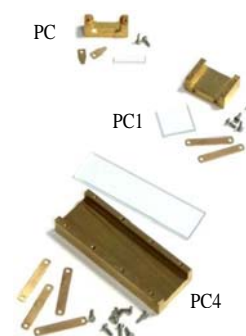

Key Features

- Simple pin-aligned mounting in PPLN ovens
- Uniform temperature distribution
- Spring clips secure the crystal with minimal stress
- ITO coated glass for electrostatic charge dissipation

Each clip kit contains:

- a clip body
- an ITO coated cover glass
- a number of springs and screws

OC2 temperature controller

The OC2 temperature controller is a compact stand-alone benchtop unit for use with our PPLN oven range. The auto-detect feature provides hassle-free, plug- and-play functionality. The user can simply dial in the required temperature and allow the oven to reach optimum stability.



Key features:

- Simple push button interface
- Set point stability $\pm 0.01^{\circ}\text{C}$
- Set point resolution 0.01°C
- Maximum temperature 200°C (250°C upon request)
- PC control interface via USB
- Auto-detect feature for all PPLN crystal ovens

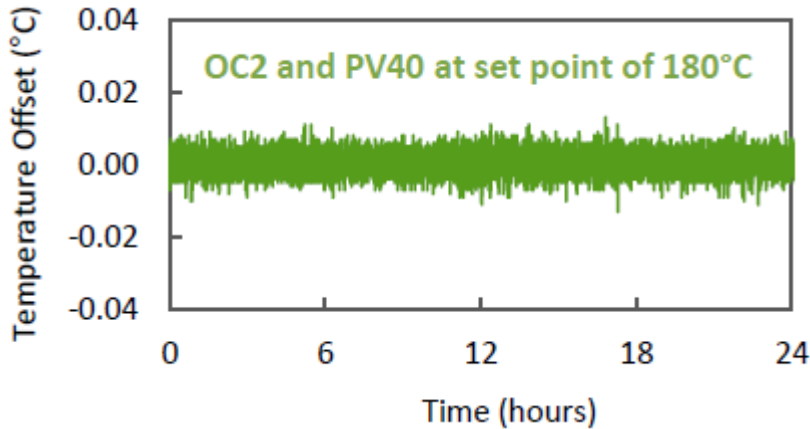

Part number	Control range	Set point resolution	Stability	For ovens	Input
STCS-OC2	Near-ambient to 200°C	0.01°C	$\pm 0.01^{\circ}\text{C}$	PV10, PV20, PV40, PV50	90-240VAC 50-60Hz

PC control:

- Standard USB type B connector
- OC2 software application
- Data saved to .csv format
- Features slow ramping via the Cycle Mode for finding SHG phase matching peak
- LabView Drivers
- PC control upgrade kit available for OC1 units: OC1-USB

Oven-free mounting solutions

Part number	Description	Optical height
STCS-PCMO01	Oven free PC01 clip mount adapter	8mm

Key features:

- PC01 clip kit secured with two nylon tipped grub screws
- M3 threaded hole
- Each PCMO01 is supplied with an M3 to M4 thread adapter

Example mounting solutions:

- M3 threaded hole allows fixture to $\varnothing 1/2$ " post assemblies
- M3 to M4 thread adapter allows fixture to $\varnothing 1$ " post assemblies

- M4 post assemblies can be fixed on to dovetail translation stages for alignment through all available gratings, as well as fine adjustment through a grating aperture

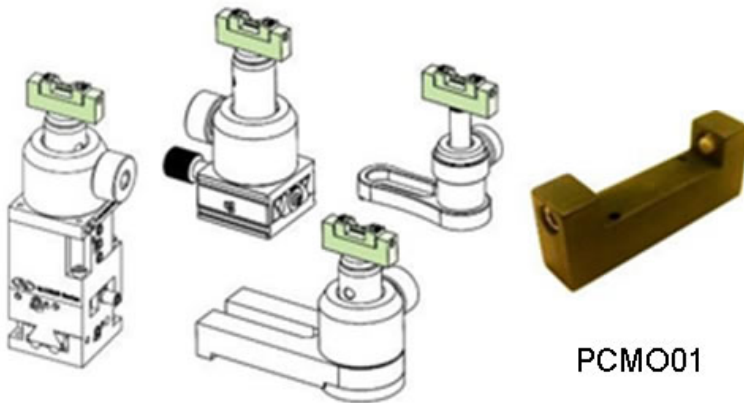

PPLN mounting example using PCMO01

Post mount adapters

Part number	Description	Optical height
STCS-PVP1	PV10 post mount adapter	25mm
STCS-PVP2	PV20, PV40 and PV50 post mount adapter	25mm



PPLN mounting example using PV10 and PV1

Flexure stage adapters:

- Compatible with standard flexure stages and mounts from major optomechanics suppliers
- PV oven and adapter have an optical height of 25mm above the flexure stage platform
- Riser plate, RP12.5, increases the optical height of standard flexure mounts from 12.5mm to 25mm



Part number	Description	Optical height
STCS-PVP1R	PV10 adapter mount for flexure stages	25mm
STCS-PVP2R	PV20 & PV40 adapter mount for flexure stages	25mm
STCS-RP12.5	12.5mm riser plate for flexure stage mounts	25mm

User Guide to PPLN

We specialise in the manufacture of periodically poled lithium niobate (PPLN) devices, such as, MgO-doped periodically poled lithium niobate (MgO:PPLN or PPMgO:LN) and undoped PPLN. These PPLN devices are used for efficient frequency conversion of lasers allowing you to reach wavelengths that cannot be achieved with conventional solid state lasers, diode lasers etc. For example, you can use PPLN to:

- frequency double a 1064nm laser to 532nm – a technique used for green laser pointers
- convert 1064nm to 3um, used for gas detection or microscopy imaging techniques

1. Principles of nonlinear frequency conversion

- Second order nonlinear processes
- Phase Matching

2. Material properties of Lithium Niobate

- Second Order Nonlinearity
- Refractive index
- Transmission
- MgO:PPLN vs undoped PPLN
- Power Handling and Damage Threshold
- Damage Mechanisms
- The Photorefractive Effect
- Green Induced Infrared Absorption

3. How to use PPLN

- Crystal length
- Polarization
- Focusing and the Optical Arrangement
- Temperature and Period

4. Example uses of PPLN

- Second Harmonic Generation
- Difference Frequency Generation
- Optical Parametric Oscillator
- Sum Frequency Generation

1. Principles of nonlinear frequency conversion

When light travels through a material, it interacts with it on an atomic and molecular level. You can think of these atoms or molecules as arrays of dipoles. The electric field from the incident light drives these dipoles causing them to oscillate like springs as it travels through the material.

In most cases, the light will be unaffected and have exactly the same frequency when it leaves the medium. However, it is possible for the light to force these dipoles to the point that they oscillate with a nonlinear response such that the re-emitted light contains additional frequencies, like the harmonics on a spring. Some materials are more prone to exhibit second order nonlinear or $\chi^{(2)}$ responses, others can be more susceptible to third-order or $\chi^{(3)}$ responses. The type of nonlinear response depends wholly on the structure of the material.

1.1 Second order nonlinear processes

Second order nonlinear processes involve the mixing of three electromagnetic waves, where the magnitude of the nonlinear response of the crystal is characterized by the $\chi^{(2)}$ coefficient. This can give rise to the following interactions:

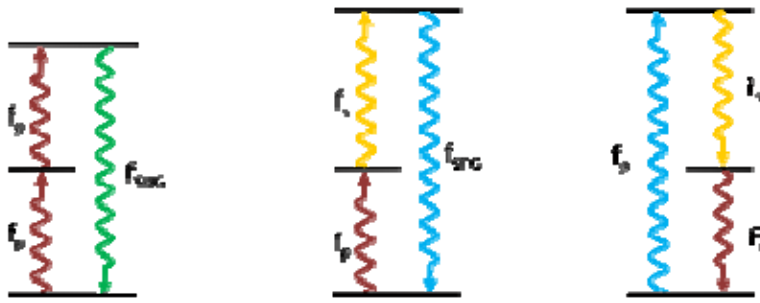

Second Harmonic

Sum Frequency

Difference Frequency

Second harmonic generation (SHG), or frequency doubling, is the most common application that utilizes the $\chi^{(2)}$ properties of a nonlinear crystal. In SHG, two input pump photons with the same wavelength λ_p are combined through a nonlinear process to generate a third photon at λ_{SHG} , where,

$$\lambda_{SHG} = \lambda_p / 2$$

OR, in terms of frequency,

$$f_{SHG} = 2f_p$$

Similar to SHG, sum frequency generation (SFG) combines two input photons at λ_p and λ_s to generate an output photon at λ_{SFG} , where,

$$\lambda_{SFG} = \left(1/\lambda_p + 1/\lambda_s\right)^{-1}$$

OR, in terms of frequency,

$$f_{SFG} = f_p + f_s$$

Alternatively, in difference frequency generation (DFG) when two input photons at λ_p and λ_s are incident on the crystal, the presence of the lower frequency signal photon, λ_s , stimulates the pump photon, λ_p , to emit a signal photon λ_s and idler photon at λ_i , where,

$$\lambda_i = \left(1/\lambda_p - 1/\lambda_s\right)^{-1}$$

OR, in terms of frequency,

$$f_i = f_p - f_s$$

In this process, two signal photons and one idler photon exit the crystal resulting in an amplified signal field. This is known as optical parametric amplification. Furthermore, by placing the nonlinear crystal within an optical resonator, also known as an optical parametric oscillator (OPO), the efficiency can be significantly enhanced.

1.2 Phase Matching

In all of these processes, photon energy is conserved; however in order for any of these the second order nonlinear interactions to occur, momentum must also be conserved. This is otherwise known as phase matching.

Phase matching refers to fixing the relative phase between two or more frequencies of light as they propagate through the crystal. The refractive index is dependent on the frequency of light. Thus, the phase relation between two photons of different frequencies will vary as the photons propagate through the material, unless the crystal is phase matched for those frequencies. It is necessary for the phase relation between the input and generated photons to be maintained throughout the crystal for efficient nonlinear conversion of input photons. If this is not the case, the generated photons will move in and out put phase with each other in a sinusoidal manner, limiting the number of generated photons that exit the crystal. This is shown in the figure below. Traditional phase matching requires that the light is propagated through the crystal in a direction where the natural birefringence of the crystal matches the refractive index of the generated light. Despite providing perfect phase matching, this technique is limited to a small range of wavelengths in those materials that can be phase matched.

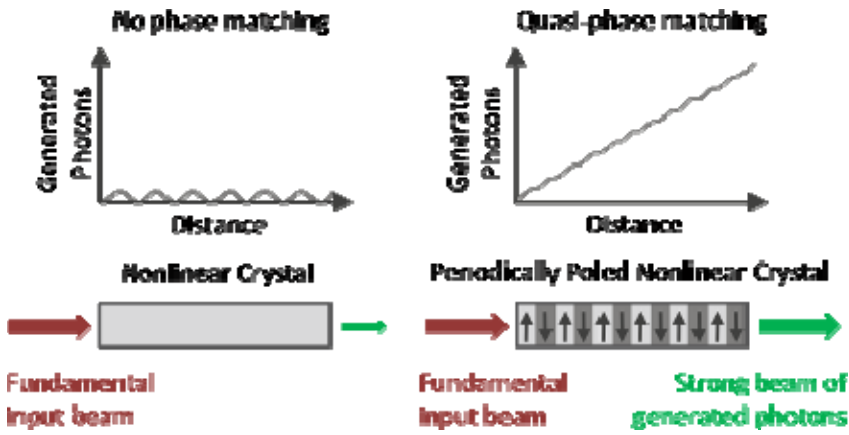

PPLN is an engineered, quasi-phase-matched material. The term engineered refers to the fact that the orientation of the lithium niobate crystal is periodically inverted (poled). By inverting the crystal orientation at every peak of the sinusoidal generation, one can avoid the photons slipping out of phase with each other. As a result, the number of generated photons will grow as the light propagates through the PPLN, yielding a high conversion efficiency of input to generated photons (see above figure).

The period with which the crystal needs to be inverted (the poling period) depends on the interacting wavelengths and the temperature of the PPLN. For example, a PPLN crystal with a poling period of 6.6µm will efficiently generate frequency doubled photons from 1060nm photons when the crystal temperature is held at 100°C. By increasing the temperature of the crystal to 200°C the same PPLN crystal will efficiently generate frequency doubled photons from 1068.6nm wavelength photons. Thus, changing the temperature of the crystal therefore varies the phase matching conditions, allowing some tuning of the wavelength interaction.

2. Material properties of Lithium Niobate

2.1 Second Order Nonlinearity

The second order nonlinear polarisation of lithium niobate can be written as,

$$\begin{pmatrix} P_x \\ P_y \\ P_z \end{pmatrix} = 2 \times \begin{pmatrix} 0 & 0 & 0 & 0 & d_{31} & -d_{22} \\ -d_{22} & d_{22} & 0 & d_{31} & 0 & 0 \\ d_{31} & d_{31} & d_{33} & 0 & 0 & 0 \end{pmatrix} \begin{pmatrix} E_x^2 \\ E_y^2 \\ E_z^2 \\ 2E_x E_y \\ 2E_x E_z \\ 2E_y E_z \end{pmatrix}$$

The 2-D matrix describes the non-susceptibility tensor $\chi(2)$. For 5% MgO doped lithium niobate (MgO:LN) at 1064nm, $d_{31}=4.4\text{pm/V}$, $d_{33}=25\text{pm/V}$.

The highest nonlinear coefficient is $d_{33}=25\text{pm/V}$, which corresponds to interactions that are parallel to the z-axis, i.e. type-0 phase matching. In other words, all interactive waves must be e-polarized in order to achieve the highest conversion efficiency. All of our crystals are designed to access this d_{33} coefficient. For periodically poled MgO:LN, the effective nonlinear coefficient d_{eff} is typically 14pm/V .

NOTE: Covesion can offer custom crystals for type I or type II interactions, for example for entangled photon systems for the generation of orthogonally polarized pairs.

Material	d_{eff} (pm/V)	Material	d_{eff} (pm/V)
MgO:PPLN	14pm/V (typical)	BBO	2.5pm/V
KTP	3.4pm/V	LBO	0.85pm/V

2.2 Refractive index

The temperature dependent refractive index is described by the Sellmeier equation:

10 Bukit Batock Crescent #07-02 The Spire Singapore 658079 Tel: 6316 7112 Fax: 63167113
<http://www.SintecOptronics.com> <http://www.sintec.sg> sales@sintec.sg sales@SintecOptronics.com

$$n_o^2 = a_1 + b_1 f + \frac{a_2 + b_2 f}{\lambda^2} + \frac{a_3 + b_3 f}{(\lambda^2 + b_3 f)^2} + \frac{a_4 + b_4 f}{\lambda^2} - a_5 \lambda^2$$

Where the temperature dependent parameter f is defined as,

$$f = (t - 24.5^\circ\text{C})(T + 570.82)$$

and the Sellmeier coefficients are,

Sellmeier Coefficient	5% MgO:LN	Undoped LN
a1	5.756	5.35583
a2	0.0983	0.100473
a3	0.2020	0.20692
a4	189.32	100
a5	12.52	11.34927
a6	1.32E-02	1.5334E-02
b1	2.860E-06	4.629E-07
b2	4.700E-08	3.862E-08
b3	6.113E-08	-8.9E-09
b4	1.516E-04	2.657E-05

Using these parameters in the Sellmeier equation, you can calculate the refractive index variation with wavelength and temperature. The table below has a few examples.

Temperature	532nm	780nm	1064nm	1550nm	3500nm
30°C	2.2260	2.1715	2.1496	2.1320	2.0732
100°C	2.2485	2.1929	2.1708	2.1530	2.0938
150°C	2.2673	2.2108	2.1884	2.1705	2.1110

PPLN has a high index of refraction that results in a ~14% Fresnel loss per uncoated surface. To increase transmission through our crystals, the crystal input and output facets are AR coated, thus reducing the reflections at each surface to less than 1%.

2.3 Transmission

MgO:LN and LN have very similar transmission curves and are highly transparent from 400-4000nm. Material absorption occurs below 400nm and above 4000nm where PPLN can still be used as long as the losses can be overcome. For example, a pulsed mid-infrared OPO generating 7.3um has been demonstrated in PPLN, although more commonly, PPLN-based OPOs are often operated up to 4.5-5um. Similarly, for the UV region, generation at 386nm and 370nm has been demonstrated using 3rd order QPM in MgO:PPLN.

Work by Schwesyg et al. have analysed the absorption losses of MgO:LN between 300 and 2950nm. Their data (shown below) provides an accurate measurement of the absorption coefficient between 400-800nm. Their experiment also found no measurable absorption bands between 800-2000nm.

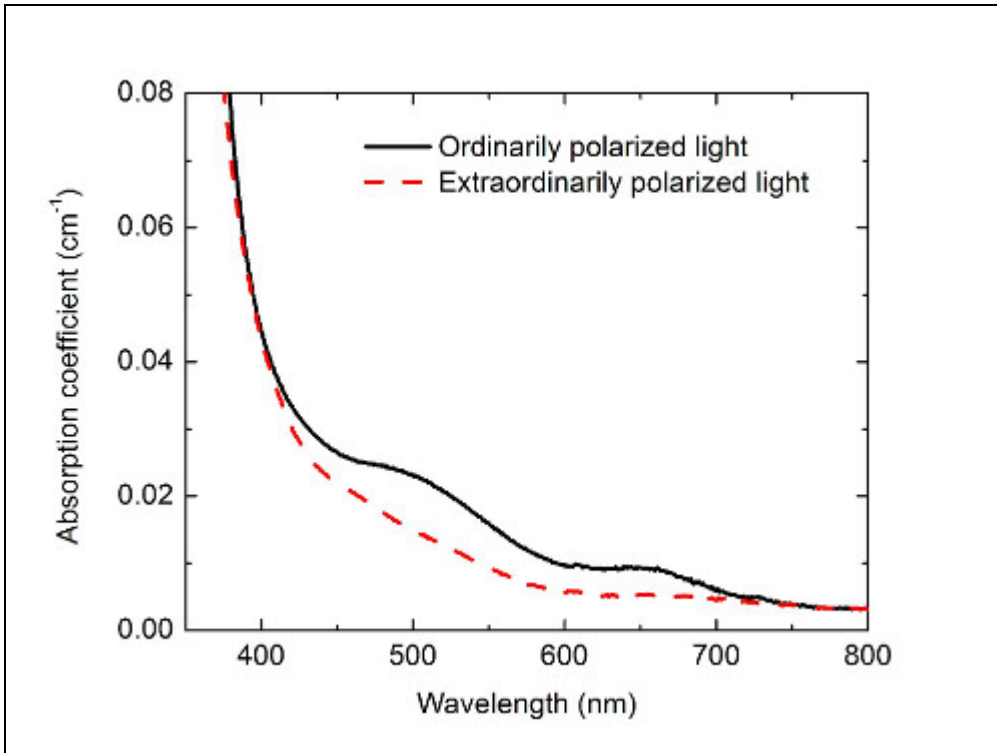

The figure below shows the transmission curves of LN and MgO:LN, showing the roll-off of transmission for both materials. The measurement includes Fresnel reflections off both input and output facets of the measured samples, which accounts for a loss of approximately 30% due to Fresnel reflections.

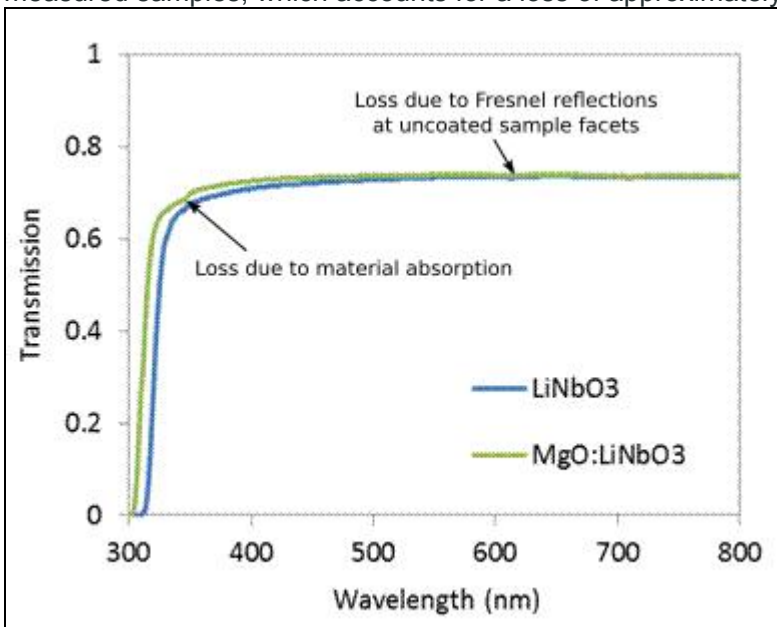

NOTE: There is an OH-absorption band at 2826nm with a measured absorption coefficient of 0.088cm⁻¹.

2.3 MgO:PPLN vs undoped PPLN

Undoped PPLN is usually operated at temperatures between 100°C and 200°C, to minimize the photorefractive effect that can damage the crystal and cause the output beam to become distorted. Since the photorefractive effect is more severe in PPLN when higher energy photons in the visible part of the spectrum are present, it is especially important to use the crystal only in the recommended temperature range.

The addition of 5% MgO to lithium niobate significantly increases the optical and photorefractive resistance of the crystal while preserving its high nonlinear coefficient. With a higher damage threshold,

MgO:PPLN is more suitable for high power applications. It can also be operated from room temperature up to 200°C, significantly increasing the wavelength tunability of the device. Moreover, in some special cases, the MgO:PPLN can be operated at room temperature and without the need for temperature control e.g. Our MSHG1550-0.5-1 (1mm long) can be used for generating 780nm from 1560nm femtosecond fibre laser.

2.4 Power Handling and Damage Threshold

Lifetime testing of our crystals is an on-going process. Using a 10W 1064nm CW laser, we have generated 2.2W at 532nm. With a pump intensity of >500KW/cm² and operating temperature of 35degC, our PPLN maintained the 2.2W SHG output power over a period of 2000hrs, with no signs of damage to the crystal and no evidence of beam distortion due to photorefraction.

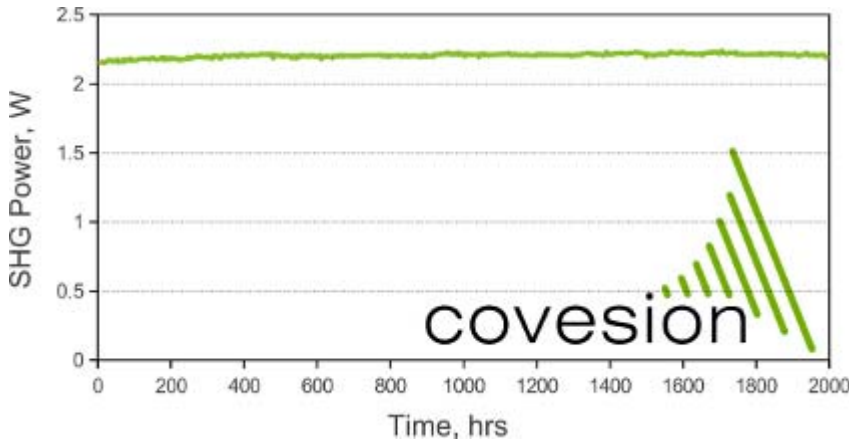

The damage threshold of MgO:PPLN or PPLN depends on wavelength as well as whether the source is CW or pulsed. In the CW regime, the threshold depends on the intensity and is lower when visible wavelengths are involved. For pulsed sources, the damage threshold depends on wavelength, pulse duration, average power and the repetition rate. Often the damage threshold will be higher for low repetition rate sources.

If you think that you are working close to the damage threshold, then a good tip is to test the damage threshold in an unpoled region of the crystal. Our crystals have a standard width of 10mm, but the poled gratings cover a maximum width ~7mm. You can use the unpoled areas to carefully test for damage as long as it is still within the AR coated region.

Note: The damage threshold in a poled region will be lower if you are generating visible wavelengths. Always increase the pump power gradually, whilst monitoring the beam for any distortions or a sudden drop in power.

The table below shows a collection of data from us and from customers showing the power handling or damage thresholds under various regimes. We are continuously working together with our customers to increase the amount of information available on crystal damage thresholds. If you would like to contribute to this, please email us.

Regime	Peak Intensity/ Energy Density	Damage?	Notes
CW	500KW/cm ²	N	1064nm, 10W, SHG (Covesion)
CW	500KW/cm ²	N	1560nm, 30W, (Australian National University)
CW	200kW/cm ²	N	532nm, 2.2W, (from 1064nm SHG) (Covesion)
ns	100MW/cm ² or 2J/cm ²	Y	1064nm, ~30um period, single pass, 10-20ns, 21Hz, (Covesion)
ps	100MW/cm ²	N	1060nm OPO, 20ps, 115MHz, 24W (ORC Southampton)
ps	1.5GW/cm ²	N	1064nm OPG for MIR: 7ps, 400Hz
ps	1.8MW/cm ²	Y	530nm OPO, 20ps, 230MHz, 500mW, (ORC)

			Southampton)
ps	7.5MW/cm ²	Y	530nm OPO, 20ps, 230MHz, 1W->100mW chopped, (ORC Southampton)
ps	468MW/cm ²	N	1064nm, 7ps, 17W, 80MHz, (National University of Singapore)
fs	4GW/cm ²	Y	1550nm, 200fs, 200mW, 80MHz, SHG

2.5 Damage Mechanisms

The Photorefractive Effect

Under conditions of high intensity, LiNbO₃ and MgO: LiNbO₃ are prone to the photorefractive effect, which is an optically induced change in refractive index. (N.B. The threshold is higher for MgO: LiNbO₃). In a region of high optical intensity, electrons are released as free carriers and then redistribute in an area of lower optical intensity. This causes a spatially varying refractive index within the material that can be observed as beam distortions. This can result in permanent damage to the crystal. However, under some circumstances, if the effects are small the damage can be reversed by heating the crystal to 200°C for a couple of hours to allow all the charge carriers to re-diffuse.

If you are working near the damage threshold, it is recommended that you operate at high temperatures between 150-200°C.

Green Induced Infrared Absorption

Green Induced Infrared Absorption, or GRIIRA, is an effect where the presence of green light allows infrared to be absorbed. This causes local heating which can offset the phase matching temperature of your interaction, but it can also eventually lead to crystal damage.

The mechanism for GRIIRA comes from the creation of polarons from crystal defects such as, Nb ions occupying Li ion sites (known as antisite defects), and Fe ion impurities. Doping lithium niobate with MgO reduces the onset of GRIIRA, as it allows Mg ions to replace the Nb antisite defects.

IR absorption due to blue light also occurs by the same mechanisms, and is known as BLIIRA (blue induced infrared absorption).

3. How to Use PPLN

To get the most out of our PPLN crystals, there are **four key aspects** that you need to consider:

- Crystal length
- Polarization
- Focusing and the optical arrangement
- Temperature and period

Crystal length

Each crystal has an associated pump acceptance bandwidth which is inversely dependent on length, so crystal length is an important factor when choosing a crystal. This acceptance bandwidth is due to the group velocity mismatch between the interacting waves.

For narrowband CW sources our longer crystal lengths, at 20 to 40mm, should give best efficiency. However, for pulsed sources, a long crystal can have a negative effect if the pump bandwidth is much broader than the crystal acceptance bandwidth. For nanosecond pulses, we typically recommend 10mm lengths and our shortest lengths at 0.5 to 1mm are ideal for femtosecond pulse systems.

For SHG of femtosecond pulses, if the pump bandwidth is significantly wider than the acceptance bandwidth, it is still possible to achieve high conversion efficiency. The pump frequencies outside of the acceptance bandwidth can still contribute to the conversion efficiency via sum frequency generation, essentially squeezing the broadband pump into a relatively narrower-band SHG pulse.

Polarization

In order to access the highest nonlinear coefficient of lithium niobate, the input light must e-polarized, i.e. the polarization must be aligned with the dipole moment of the crystal. This is accomplished by

aligning the polarization axis of the light parallel to the thickness of the crystal. This applies to all nonlinear interactions.

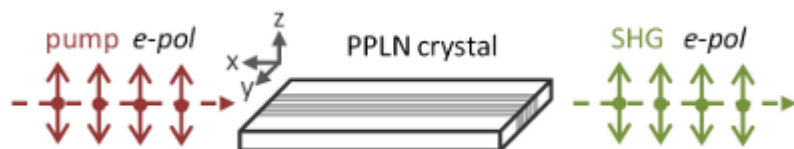

This configuration is known as Type-0 phase matching (ee-e), as all the interacting beams have the same polarization.

Type I phase matching (oo-e) and type II phase matching (eo-e) schemes are also possible in PPLN, for example for the generation of heralded single photons. Please contact Covesion to discuss your requirements.

Focusing and the Optical Arrangement

Typically, our crystals consist of several grating periods each with a 0.5x0.5mm², or 1.0x1.0mm² aperture and with a length of up to 40mm long. To achieve high conversion efficiency in PPLN, the pump beam should be focussed into a grating with the focus centred on the crystal length.

For SHG with CW lasers, a theoretical result from Boyd and Kleinmann shows that optimum efficiency can be achieved when the ratio of the crystal length to the confocal parameter is 2.84. (The confocal parameter is twice the Rayleigh range). This is also true for SFG interactions where the two pump beams should also have the same Rayleigh range.

For DFG and OPOs, optimum efficiency requires a confocal focussing condition i.e. the Rayleigh range is half the length of the crystal.

These focussing conditions apply to pulsed lasers too, but due to the high peak powers, the spot size requirements are less sensitive. (Be aware of the crystal damage threshold so as not to focus too tightly.)

In general, a good rule of thumb is that the spot size should be chosen such that the Rayleigh range is half the length of the crystal. The spot size can then be reduced in small increments until the maximum efficiency is obtained.

Temperature and Period

The poling period of a PPLN crystal is determined by the wavelengths of light being used. The quasi-phase-matched wavelength can be tuned slightly by varying the temperature of the crystal.

Our range of off-the-shelf PPLN crystals each include multiple different poling periods, which allow different wavelengths to be used at a given crystal temperature. Our calculated tuning curves give a good indication of the required temperature for phase-matching. The temperature dependence of conversion efficiency follows a sinc² function, describing a crystal temperature acceptance bandwidth. The longer the crystal, the narrower and more sensitive the acceptance bandwidth.

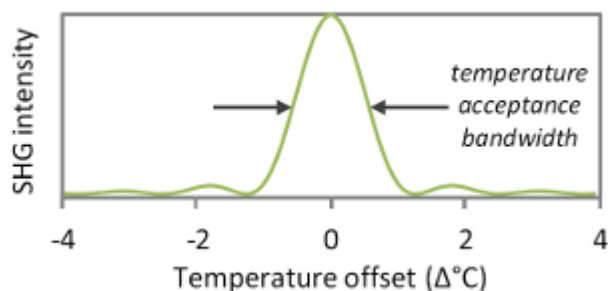

In many cases the efficiency of the nonlinear interaction is very sensitive to <math><1^\circ\text{C}</math>. For example, for SHG with a 1064nm pump in a 20mm long crystal, the temperature acceptance bandwidth is $\sim 1^\circ\text{C}$. So if the temperature is 0.5°C off from the optimum phase matching temperature, then the SHG power is 50% lower than the optimum. If the crystal temperature can be maintained at the optimum phase matching temperature to within $\pm 0.1^\circ\text{C}$, then the SHG power is stable to within 2-3%.

The optimum temperature can be determined by heating the crystal to 20°C higher than the calculated temperature and then allowing the crystal to cool whilst monitoring the output power at the generated wavelength.

Our PPLN oven is easy to incorporate into an optical setup. It can be paired with our OC1 temperature controller to maintain the crystal temperature to within $\pm 0.01^\circ\text{C}$, providing highly stable output power.

4. Example uses of PPLN

4.1 Second Harmonic Generation

PPLN can be used in a single pass configuration for SHG with the pump focussed at the centre of the crystal length. For optimum efficiency, aim for the Boyd-Kleinman focussing condition. This is where the spot size is such that the ratio of the crystal length to the confocal parameter is 2.84.

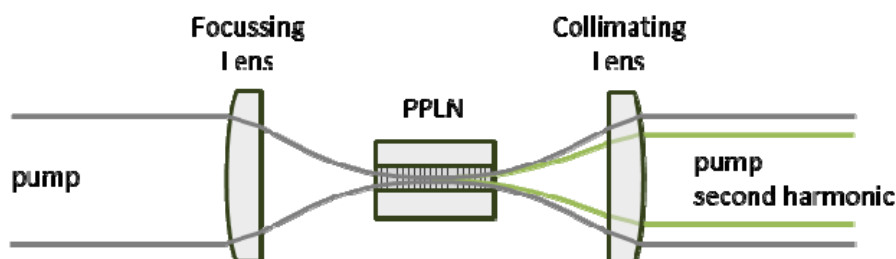

The optimum conversion efficiency that can be achieved for an SHG interaction also depends on several factors such as:

- CW or pulsed pump source
- Input power: at high power, you can reach gain saturation
- Pump/SHG wavelength: At low gain, conversion efficiency is higher for interactions involving higher energy photons (short wavelength).

1064nm → 532nm

For low gain CW the typical conversion efficiency is 2%/Wcm. For example, for 1.5W at 1064nm and a 40mm long MgO:PPLN crystal, the expected 532nm output is 180mW. At higher powers, we have achieved 1.5%/Wcm with a 10W source, generating 3W at 532nm from a 20mm long crystal. In CW systems, conversion efficiencies in excess of 50% have been demonstrated in an intracavity arrangement. For nanosecond sources ($\sim 10\text{KHz}$, $\sim 50\mu\text{J}$), efficiencies of 50% can typically be achieved.

1550nm → 775nm

Frequency doubling of Erbium doped fibre lasers is also common, for example for 775nm or 780nm generation. For a CW source, you can typically achieve 0.6%/Wcm for low gain. At high powers an efficiency of 0.3%/Wcm has been demonstrated for generating 11W at 780nm in a 40mm long crystal with 30W pump power.

For a nanosecond source, up to 80% conversion efficiency has been demonstrated in a single pass pulsed system. For femtosecond sources, using a 1mm crystal length, customers have reported efficiencies of 40-60% for $\sim 100\text{fs}$, 100MHz and several hundred mW average powers. Due to the very wide temperature acceptance bandwidth, our MSHG1550-0.5-1 crystal can be used at room temperature, and with no temperature controller, for SHG at 1550 or 1560nm.

4.2 Difference Frequency Generation

PPLN is often used in a DFG setup for mid-IR generation, either with a tuneable Ti:S laser and 1550nm laser, or a 1064nm source and tuneable $\sim 1550\text{nm}$ laser. Optimum efficiency requires confocal focussing of both pump beams, i.e. ratio of the crystal length to the confocal parameter is 1. For CW systems, efficiencies of 0.3-0.4mW/W²cm can be achieved.

4.3 Optical Parametric Oscillator

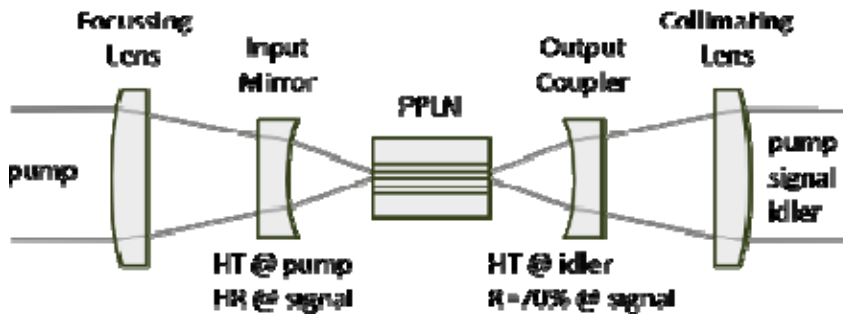

One of the most common uses of PPLN is in an Optical Parametric Oscillator (OPO). A schematic of an OPO is shown above. The common arrangement uses a 1064nm pump laser and can produce signal and idler beams at any wavelength longer than the pump laser wavelength. The exact wavelengths are determined by two factors: energy conservation and phase matching. Energy conservation dictates that the sum of the energy of a signal photon and an idler photon must equal the energy of a pump photon. Therefore an infinite number of generated photon combinations are possible. However, the combination that will be efficiently produced is the one for which the periodicity of the poling in the lithium niobate creates a quasi-phase matched condition. The combination of wavelengths that is quasi-phase matched, and hence referred to as the operation wavelength, is altered by changing the PPLN temperature or by using PPLN with a different poling period. Nd:YAG pumped OPOs based on PPLN can efficiently produce tunable light at wavelengths between 1.3 and 5 μ m and can even produce light at longer wavelengths but with lower efficiency. The PPLN OPO can produce output powers of several watts and can be pumped with pulsed or CW pump lasers.

The minimum oscillation threshold can be achieved under confocal focussing conditions for the pump and resonating signal or idler, i.e. ratio of the crystal length to the confocal parameter is 1. The typical pump threshold for a singly resonant CW OPO is around 1-2W.

4.4 Sum Frequency Generation

To achieve efficient SFG, you ideally want the two pump beams to be confocally focussed into the PPLN (i.e. ratio of the crystal length to the confocal parameter is 1) and for both beams to be roughly equal in power.

SFG in PPLN is often used for laser cooling of atoms or ions where very precise control over the frequencies is required. For generation of 626nm light from 1051nm and 1551nm, efficiencies of 3.5-2.5%/Wcm have been achieved. Here, the efficiency η , is defined by:

$$\eta = \frac{P_{626}}{P_{1051} P_{1551} l}$$

Where P is the power at each wavelength, and l is the crystal length. An efficiency of 44% has been demonstrated for the generation of 7.2W of 626nm light from 1051nm (8.5W) and 1551nm (8.3W). A similar conversion efficiency of 3.2%/Wcm has also been reported for 589nm generation from 1064nm and 1319nm.