

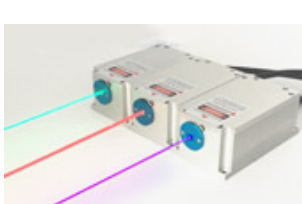







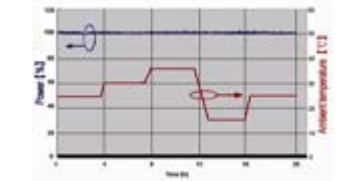
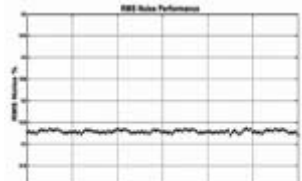
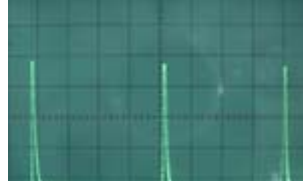

Diode Laser Modules and DPSS Lasers

Sorted by Wavelength

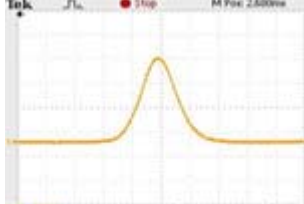

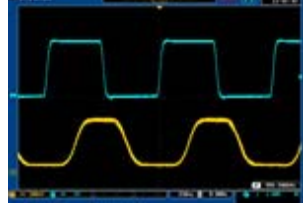







Sorted by Laser Performance

 <p>DPSS Laser High stability, low noise, ultra narrow linewidth, high power & energy, picosecond laser...</p>	 <p>Diode Laser Narrow linewidth, DFB laser, long coherence length, picosecond laser..</p>	 <p>Fiber Laser SM/ MM fiberl, pulse width <200ps or tunable 1~250 ns. Modulation up to 1 MHz</p>	 <p>Multi-wavelength Laser Multi-wavelength (2~20) output, free space or fiber coupling output optional.</p>
 <p>Power stability (<1%, 20 hours) environment temperature 10-35°C</p> <p>High Stability Laser Wavelength: 257-4800nm Power stability <0.1%, 0.3%, 0.5%, 1%.</p>	 <p>Noise of Amplitude(pk-pk, 1~20MHz)<0.25%</p> <p>Low Noise Laser Noise of amplitude <0.2% Power stability <0.1%, 0.3%, 0.5%, 1%.</p>	 <p>Single Frequency Laser Single longitudinal mode lasers, Coherent length >100 m, Linewidth <0.000001nm</p>	 <p>Wavelength Tunable Laser Multi-wavelength bands optional, Min. linewidth <0.06nm</p>
 <p>High Power Laser Wavelength: 532/ 556/ 589 /660/ 1064/ 1319 nm, Power: 1W~500W</p>	 <p>High Energy Laser Wavelength: 266/ 355/ 532/1064/1319/1573nm, Energy: 1mJ~20J</p>	 <p>Q-switched Pulsed Laser Pulse duration: 0.8ns~200 ns; Rep. rate: 1Hz~200kHz</p>	 <p>Mode-locked & ps Laser Pulse duration <10ps; Rep. rate: 0.1-80MHz</p>
 <p>OEM Laser Module Ultra compact size and high compatibility, suitable for OEM instrumentation and systems.</p>	 <p>Fiber Coupled Laser MM/ SM/ PM or liquid-core fiber optional, with high coupling efficiency and good homogenization effect.</p>	 <p>High Frequency Modulation Up to 150 MHz modulation rate, for single longitudinal mode and high stability laser.</p>	 <p>Line Laser Fan angles of 5°, 7°, 10°, 30°, 45° 60°, 75°, 90° and 100°, line beam uniform and with good flatness.</p>

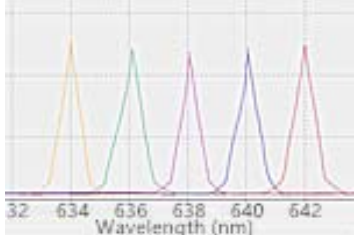
Customized lasers

We specialize in designing and manufacturing custom-made and OEM lasers to suit our clients' particular needs. If you don't find a specific product or accessory from above listed products, please contact us for custom-design and fabrication. We can re-design the optical, mechanical, and/or electrical components of the lasers to provide the perfect solution for you. We have the R&D, engineering, and production expertise to manufacture the lasers that are able to maintain integrity in various extreme settings and conditions.

1. Diode Lasers

 <p>High Stability Laser Good beam quality, ultra compact, Long-term stability <1%</p>	 <p>TEM₀₀ Mode Diode Laser Perfect beam with TEM₀₀ mode</p>	 <p>Wavelength Tunable Laser Multi-wavelength bands optional Min. linewidth <0.06nm</p>
 <p>Narrow Linewidth Laser Linewidth <0.06 nm (<0.03 nm optional)</p>	 <p>Ultra Narrow Linewidth Laser Ultra narrow linewidth <math>8 \times 10^{-8}</math> nm</p>	 <p>Long Coherence Length Laser Coherence length >1 m 400nm-642nm wavelength available</p>
 <p>Nanosecond Pulsed Laser Tunable pulse width 5 - 150 ns 405 - 1550 nm available</p>	 <p>Picosecond Pulsed Laser Rep. rate 0.1 ~ 80 MHz Pulse width 100 - 1000 ps</p>	 <p>DFB/ DBR/ VCSEL Laser Narrow linewidth up to 2 MHz</p>

1.1 TEM00 Mode Diode Laser

We offer TEM00 mode diode laser, which is made features of TEM00 mode, high performance, ultra compact, long lifetime, low cost and easy operating. It is widely used in measurement, communication, scientific experiment, spectrum analysis, optical instrument and so on, are the perfect choice for design in and integration into OEM instrumentation and systems and also for end user applications in research and development.



Model	Operating mode	Output power (mW)	M ² factor
STC-TEM-F-405	CW	1~30	<1.1
STC-TEM-F-450	CW	1~20	<1.1
STC-TEM-F-488	CW	1~15	<1.1
STC-TEM-F-520	CW	1~20	<1.1
STC-TEM-F-635	CW	1~80	<1.1
STC-TEM-F-640	CW	1~40	<1.1
STC-TEM-F-660	CW	1~50	<1.1
STC-TEM-F-685	CW	1~20	<1.1
STC-TEM-F-785	CW	1~40	<1.1
STC-TEM-F-808	CW	1~20	<1.1
STC-TEM-F-830SLD	CW	1~20	<1.1
STC-TEM-F-830	CW	1~60	<1.1
STC-TEM-F-1310	CW	1~5	<1.1
STC-TEM-F-1053SLD	CW	1~8	<1.1
STC-TEM-F-1550	CW	1~5	<1.1

1.2 Long Coherence Length STC-MDL-C Series Diode Lasers

STC-MDL-C series lasers, with the characteristic of long coherence length >1m, are ideal for application in holography, photoetching interference, DNA sequencing, flow cytometry, digital imaging, analytical chemistry, particle measurement, confocal microscopy, Raman spectroscopy and many other fields. Housed in ultra compact package, these lasers are the perfect choice for OEM instrumentation, systems design and integration, and also for end user applications in research and development.



Model	Wavelength (nm)	Output power (mW)	Coherent length (m)
STC-MDL-C-400	400	1~50	>1
STC-MDL-C-405	405	1~50	>1
STC-MDL-C-410	410	1~50	>1
STC-MDL-C-415	415	1~50	>1
STC-MDL-C-442	442	1~30	>1
STC-MDL-C-445	445	1~30	>1
STC-MDL-C-447	447	1~30	>1
STC-MDL-C-450	450	1~30	>1
STC-MDL-C-457	457	1~30	>1
STC-MDL-C-488	488	1~70	>1
STC-MDL-C-514.5	514.5	1~40	>1
STC-MDL-C-520	520	1~10	>1
STC-MDL-C-635	635	1~30	>1
STC-MDL-C-637	637	1~80	>1
STC-MDL-C-640	640	1~30	>1
STC-MDL-C-642	642	1~30	>1

1.3 Nanosecond Pulsed Diode Laser

We offer nanosecond pulsed diode laser, with tunable pulse width 10ns-10ms (external trigger), good beam profile and high power stability. It has ultra compact design that can be easily integrated into customers instrument. This series laser can be widely used in microelectronics, solar energy, material processing, equipment integration, etc..



Features:

High frequency modulation; Good beam profile; Integrated electronics; Compact size

Applications:

Microelectronics; Material processing; Solar energy; Equipment integration

STC-MDL-NS Series

Model	Wavelength	Output Power @3.3VDC (CW)	User Trigger Frequency (MHz)	Pulse Width (tunable, external trigger mode)
STC-MDL-NS-405	405 nm	1-500 mW	Up to 80	10ns -10 ms
STC-MDL-NS-450	450 nm	1-80 mW	Up to 50	10ns -10 ms
STC-MDL-NS-520	520 nm	1-100 mW	Up to 50	10ns -10 ms
STC-MDL-NS-635	635 nm	1-200mW	Up to 40	10ns -10 ms
STC-MDL-NS-642	642 nm	1-80 mW	Up to 30	10ns -10 ms
STC-MDL-NS-655	655 nm	1~180 mW	Up to 30	10ns -10 ms
STC-MDL-NS-785	785 nm	1-100 mW	Up to 30	10ns -10 ms
STC-MDL-NS-808	808 nm	1-100 mW	Up to 40	10ns -10 ms
STC-MDL-NS-830	830 nm	1-120 mW	Up to 20	10ns -10 ms
STC-MDL-NS-852	852 nm	1-150 mW	Up to 30	10ns -10 ms
STC-MDL-NS-915	915 nm	1-200 mW	Up to 30	10ns -10 ms
STC-MDL-NS-980	980 nm	1-200 mW	Up to 40	10ns -10 ms
STC-MDL-NS-1060	1060 nm	1-200 mW	Up to 40	10ns -10 ms

STC-MDL-III-P Series

Model	Wavelength	Peak Power	Repetition Rate	Pulse Width
STC-MDL-III-P-905	905 nm	~135W (@10kHz)	1~10kHz	~20ns (@10kHz)
STC-MDL-III-P-1550	1550 nm	~15.3W (@6kHz)	1~6kHz	~150ns (@6kHz)

1.4 DFB/ DBR/ VCSEL Laser

We offer DFB/ DBR/ VCSEL laser, which is special designed for gas detection such as CH₄, H₂S, NH₃, H₂O, CO, CO₂, C₂H₄, HF, C₂H₂, etc. Features with narrow linewidth up to 2MHz, ultra compact dimension, high power and wavelength stability, they are widely used in fiber gas detection, seed light source, fiber optical sensing field, etc.



Features:

Stable wavelength and output power; Narrow linewidth; No jump mode output in operating current range

Applications:

Optical fiber gas detection system; Optical sensing; Fiber communications

Laser Wavelength for Gas Detection

as Composition	Chemical Formula	Absorption Spectrum
Methane	CH ₄	1650.9 nm, 1653.7 nm
Hydrogen sulfide	H ₂ S	1578 nm, 1590 nm
Ammonia	NH ₃	1512 nm
Carbon monoxide	CO	1567 nm
Carbon dioxide	CO ₂	1580 nm
Acetylene	C ₂ H ₂	1532.68 nm
Ethylene	C ₂ H ₄	1620 nm, 1625 nm, 1627 nm

Hydrogen fluoride	HF	1268.7 nm, 1273 nm, 1305 nm, 1312 nm
Water	H ₂ O	1368 nm, 1392 nm

Lasers for Fiber Communication:

Model	Wavelength	Output Power
STC-TEM-F-1268DFB	1268 nm	1-10 mW
STC-TEM-F-1273DFB	1273 nm	1-10 mW
STC-TEM-F-1305DFB	1305 nm	1-10 mW
STC-TEM-F-1310DFB	1310 nm	1-10 mW
STC-TEM-F-1312DFB	1312 nm	1-10 mW
STC-TEM-F-1368DFB	1368 nm	1-10 mW
STC-TEM-F-1392DFB	1392 nm	1-10 mW
STC-TEM-F-1450DFB	1450 nm	1-20 mW
STC-TEM-F-1470DFB	1470 nm	1-20 mW
STC-TEM-F-1490DFB	1490 nm	1-20 mW
STC-TEM-F-1512DFB	1512 nm	1-10 mW
STC-TEM-F-1532DFB	1532 nm	1-20 mW
STC-TEM-F-1540DFB	1540 nm	1-20 mW
STC-TEM-F-1550DFB	1550 nm	1-30 mW
STC-TEM-F-1560DFB	1560 nm	1-20 mW
STC-TEM-F-1567DFB	1567 nm	1-10 mW
STC-TEM-F-1573DFB	1573 nm	1-20 mW
STC-TEM-F-1578DFB	1578 nm	1~10 mW
STC-TEM-F-1580DFB	1580 nm	1~10 mW
STC-TEM-F-1590DFB	1590 nm	1-20 mW
STC-TEM-F-1610DFB	1610 nm	1-20 mW
STC-TEM-F-1620DFB	1620 nm	1~10 mW
STC-TEM-F-1625DFB	1625 nm	1~10 mW
STC-TEM-F-1627DFB	1627 nm	1~10 mW
STC-TEM-F-1651DFB	1651 nm	1~10 mW
STC-TEM-F-1653DFB	1653 nm	1~10 mW

2. Fiber Lasers

We offer fiber lasers with compact OEM modular design which is ideal for systems integration. They are widely used in communication, lidar, medical cosmetology, optical instrument, interference, holography, spectrum analysis, pump source, measurement, physics experiment, etc. The 1550 nm and 1064nm fiber laser are in single longitudinal and polarized mode. The pulsed mode up to 1MHz modulation and pulse duration variation are also available.



Model	Wavelength (nm)	Output power (mW)	Pulse width	Modulation rate	Longitudinal mode	Polarization
STC-FL-266-PS	266	1-10	<10 ps	20-60 MHz	Multi-	>15dB
STC-FL-343-PS	343	1-50	<10 ps	20-50 MHz	Multi-	>15dB
STC-FL-355-PS	355	1-50	<10 ps	20-60 MHz	Multi-	>15dB
STC-FL-515-PS	515	1-200	<10 ps	20-50 MHz	Multi-	>15dB
STC-FL-532-PS	532	1-150	<10 ps	20-60 MHz	Multi-	>15dB
STC-FL-1030-PS	1030	1-2000	<10 ps	20-50 MHz	Multi-	Random/ >15dB
STC-FL-1030-PS-Seed	1030	0.5-1	<10 ps	20-50 MHz	Multi-	Random/ >15dB
STC-FL-1064-PS	1064	1-2000	<10 ps	20-60 MHz	Multi-	Random/ >15dB
STC-FL-1064-PS-Seed	1064	0.5-1	<10 ps	20-60 MHz	Multi-	Random/ >15dB
STC-FL-266-Pico	266	1-50	100-900 ps	0.1-20 MHz	Multi-	>15dB
STC-FL-343-Pico	343	1-50	100-900 ps	0.1-20 MHz	Multi-	>15dB
STC-FL-355-Pico	355	1-50	100-900 ps	0.1-20 MHz	Multi-	>15dB
STC-FL-515-Pico	515	1-1000	100-900 ps	0.1-20 MHz	Multi-	>15dB
STC-FL-532-Pico	532	1-1000	100-900 ps	0.1-20 MHz	Multi-	>15dB
STC-FL-535-Pico	535	1-1000	100-900 ps	0.1-20 MHz	Multi-	>15dB

STC-FL-1030-Pico	1030	10-5000	100-900 ps	0.1-20 MHz	Multi-	Random/ >15dB
STC-FL-1064-Pico	1064	10-5000	100-900 ps	0.1-20 MHz	Multi-	Random/ >15dB
STC-FL-1070-Pico	1070	10-5000	100-900 ps	0.1-20 MHz	Multi-	Random/ >15dB
STC-FL-1030-S	1030	1 uW-200 mW Peak power	5-100 ns (Adjustable)	1 Hz-10 MHz	Multi-	Random/ >15dB
STC-FL-1064-S	1064	1 uW-500 mW Peak power	5-100 ns (Adjustable)	1 Hz-10 MHz	Multi-	Random/ >15dB
STC-FL-1550-S	1550	1uW-10 mW Peak power	5-100 ns (Adjustable)	1 Hz-10 MHz	Multi-	Random/ >15dB
STC-FL-266-Nano	266	1-50	0.5-50 ns	0.1-1 MHz	Multi-	>15dB
STC-FL-343-Nano	343	10-300	0.5-50 ns	0.1-1 MHz	Multi-	>15dB
STC-FL-355-Nano	355	1-300	0.5-50 ns	0.1-1 MHz	Multi-	>15dB
STC-FL-515-Nano	515	1-1000	0.5-50 ns	0.1-1 MHz	Multi-	>15dB
STC-FL-532-Nano	532	1-1000	0.5-50 ns	0.1-1 MHz	Multi-	>15dB
STC-FL-535-Nano	535	1-1000	0.5-50 ns	0.1-1 MHz	Multi-	>15dB
STC-FL-1030-Nano	1030	0.5-10 W	0.5-250 ns (Variable)	0.1-1 MHz	Multi-	Random/ >15dB
STC-FL-1064-Nano	1064	1000-5000	0.5-250 ns (Variable)	0.1-1 MHz	Multi-	Random/ >15dB
STC-FL-1070-Nano	1070	0.5-10 W	0.5-250 ns (Variable)	0.1-1 MHz	Multi-	Random/ >15dB
STC-FL-1550-Nano	1550	50-1000	0.5-50 ns (Variable)	50-1000 kHz	Multi-	Random/ >15dB
STC-FL-532-AO	532	10-100 nJ	0.5-50 ns	1-1000 Hz	Multi-	Random/ >15dB
STC-FL-1064-AO	1064	1-20 uJ	0.5-50 ns	1-1000 Hz	Multi-	Random/ >15dB
STC-FL-1550-AO	1550	1-20 uJ	0.5-50 ns	1-200 Hz	Multi-	Random/ >15dB
STC-FL-1064-CW	1064	1-20 W	N/A	CW/ modulated	Multi-	Random/ >15dB
STC-FL-1080-CW	1080	1-20 W	N/A	CW/ modulated	Multi-	Random/ >15dB
STC-FL-1550-CW	1550	1-20 W	N/A	CW/ modulated	Multi-	Random/ >15dB
STC-FL-1064-SF	1064	1-500	N/A	CW	Single	>15dB
STC-FL-1550-SF	1550	1-1000	N/A	CW	Single	>15dB

3. Multi-line Laser/ Multi-wavelength Laser

We offer multi-line laser/ multi-wavelength laser combiner systems in free space and fiber output, it can combine multiple wavelengths into one box, with optional USB or RS232 control. The wavelengths are available for UV-Visible-IR range. This multi-line lasers can be widely used for medical, biomedical, and industrial application, etc.

3.1 Free Space Output

- Separate laser head and driver for easy integration
- 320-1064nm wide range of wavelengths available
- 2-4 wavelengths can be combined into one system (more wavelengths on request)
- Customized wavelength and output power combinations
- Free space or MM fiber output optional

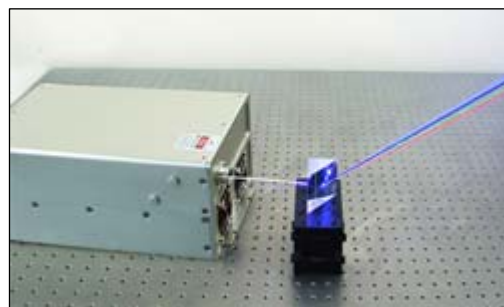

Specifications: (X stands for the number of wavelength, X= II, III, IV)

Model	STC-MSX-M	STC-MSX-S	STC-MSX-N	STC-MSX-W	STC-MSX-Z
Power supply	STC-PSU-M-LED		STC-RGB-31/ RGB-41		
Number of combined wavelengths	2~4 (Or more on request)				
Output mode	Free coaxially output (fiber output optional)				
Available Wavelength (nm)	320~1064				
Output power (mW)	Available for customized on request				
Power stability (rms, over 4	<1%, <2%, <3%, <5%				

hours)	
Operating mode	CW, TTL or analog on request
Operating temperature (°C)	10~35°C
Power input	100~240VAC
Cooling method	Air cooled
Expected lifetime (hours)	10000
Options:	<ul style="list-style-type: none"> • TTL or analog modulation up to 30kHz • AOM (modulation up to 1MHz) • MM fiber coupling (100um, ..., 600um), SMA905/ FC connector optional • USB or RS232 control

Standard model:

- ◆405nm/ 561nm ◆473nm/ 593.5nm ◆405nm/ 473nm/ 532nm ◆640nm/ 532nm/ 405nm
- ◆405nm/ 589nm ◆635nm/ 532nm ◆635nm/ 532nm/ 473nm ◆655nm/ 532nm/ 473nm
- ◆405nm/ 593.5nm ◆655nm/ 532nm ◆637nm/ 532nm/ 447nm ◆671nm/ 532nm/ 473nm
- ◆473nm/ 589nm

3.2 Fiber Coupling Version

- Single mode fiber coupling with stable output
- Separate laser head and driver for easy integration
- 320-1064nm wide range of wavelengths available
- 2-4 wavelengths can be combined into one system (more wavelengths on request)
- Customized wavelength and output power combinations
- Customized size available



Standard model:

- ◆637nm/ 532nm ◆637nm/ 532nm/ 473nm ◆640nm/ 561nm/ 488nm/ 405nm
- ◆671nm/ 532nm/ 457nm ◆640nm/ 593.5nm/ 532nm/ 488nm ◆642nm/589nm/532nm/473nm

3.3 Integrated Electronics:

- Built-in driver for easy operation
- 375-1550nm wide range of wavelengths available
- 2-20 wavelengths can be combined into one system
- Customized wavelength and output power combinations
- Customized size available



Channel type	Single Channel			Multi-Channel
Model	STC-FC-MS	STC-FC-ML	Customized model	STC-FC-MS-CH
Available wavelength (nm)	375~1064			375~1550
Number of combined wavelengths	2~3	4~6	7~20	2~4
Fiber type	SM, MM			SM
Fiber core diameter (µm)	Customized on request			4~9
Fiber connector	SMA905/ FC			FC/PC
Output power	Customized on request			
Power stability (rms, over 4 hours)	<3%, <5%			
Operating mode	CW, TTL or analog on request			
Operating temperature(°C)	10~35			

Power input	100~240VAC
Cooling method	Air cooled
Expected lifetime (hours)	10000
Warranty	1 year

Standard model:

◆405nm/ 447nm/ 532nm/ 637nm ◆405nm/ 488nm/ 532nm/ 637nm

4. Wavelength Tunable Laser

We offer wavelength tunable laser, the output wavelengths can be changed continuously within a certain range. Tunable lasers come with good beam quality, high stability and long life time, they are widely used in spectroscopy, photochemistry, medicine, biology, integrated optics, laser processing, etc.

Features:

Good beam quality; Compact design; High stability; Long life time; Easy operation

Applications:

Spectroscopy; Medicine; Photochemistry; Biology; Integrated optics



◆**Tunable Diode Laser**

Tunable Wavelength Band	Model	Output Power	Spectral Linewidth
403~407 nm	STC-TUN-403~407	1~30 mW	<0.1 nm
408~412 nm	STC-TUN-408~412	1~30 mW	<0.1 nm
448~452 nm	STC-TUN-448~452	1~10 mW	<0.1 nm
518~522 nm	STC-TUN-518~522	1~10 mW	<0.1 nm
634~643 nm	STC-TUN-634~643	1~10 mW	<0.1 nm
652~658 nm	STC-TUN-652~658	1~10 mW	<0.1 nm

◆**Tunable Ti:Sapphire Laser**

Tunable Wavelength Band	Model	Output Power	Spectral Linewidth
770~840 nm	STC-TUN-TiN-770~840	1~400 mW	<40 pm
770~840 nm	STC-TUN-Ti-770~840	1~1000 mW	<2 nm
770~840 nm	STC-TUN-TiA-770~840	1~1300 mW	<2 nm

◆**Tunable Infrared Laser**

Tunable Wavelength Band	Model	Output Power	Spectral Linewidth
1400~1800 nm	STC-TUN-W-1400~1800	1~2000 mW	<2 nm
2600~4450 nm	STC-TUN-W-2600~4450	1~1000 mW	<2 nm

5. Mode-locked & Picosecond Laser Series

Superior beam quality, best reliability, mode-locked & picosecond pulsed laser, pulsed duration could be less than 20ps. Housed in compact packages, are the perfect choice for design in and integration into OEM instrumentation and systems and also for end user applications in research and development.



Applications:

Raman spectroscopy; Marking, Carving; Material processing; Astronomy; Scientific research; Optical instrument

Mode-locked Type:

	Wavelength	Output	Pulse duration	Rep. rate	Operating	Transverse
--	------------	--------	----------------	-----------	-----------	------------

	(nm)	power (mW)	(ps)	(MHz)	mode	mode
STC-PS-R-266	266	1-50	<20	48±1	Mode-locked	TEM ₀₀
STC-PS-R-355	355	1-2000	<20	48±1	Mode-locked	TEM ₀₀
STC-PS-R-532	532	1-3000	<20	48±1	Mode-locked	TEM ₀₀
STC-PS-HR-532	532	1-2 W	~15@500kHz&2 W	100-1000kHz	Mode-locked	TEM ₀₀
STC-PS-RL-1064	1064	1-1000	~15 @10 kHz&1 W	1-10kHz	Mode-locked	TEM ₀₀
STC-PS-HR-1064	1064	1-10 W	~15@500kHz&10W	100-1000kHz	Mode-locked	TEM ₀₀
STC-PS-R-1064	1064	1-10 W	<20	48±1	Mode-locked	TEM ₀₀
STC-PS-Seed-1064	1064	1-300	<20	80±1	Mode-locked	TEM ₀₀
Macro/ Micro-1064-P	1064	10 W	Macro 160 μs	Micro~100MHz	Mode-locked	TEM ₀₀
Macro/ Micro-1319-P	1319	7 W	Macro 160 μs	Micro~100MHz	Mode-locked	TEM ₀₀

Fiber Laser Type:

	Wavelength (nm)	Output power (mW)	Pulse duration (ps)	Rep. rate (MHz)	Operating mode	Transverse mode
STC-FL-266-PS	266	1-10	<10	20-80 (Fixed)	Mode-locked	TEM ₀₀
STC-FL-355-PS	355	1-50	<10	20-80 (Fixed)	Mode-locked	TEM ₀₀
STC-FL-532-PS	532	1-150	<10	20-80 (Fixed)	Mode-locked	TEM ₀₀
STC-FL-1064-PS	1064	1-2000	<10	20-80 (Fixed)	Mode-locked	TEM ₀₀
STC-FL-266-Pico	266	1-50	100-900	0.1-20 (variable)	Pulsed	TEM ₀₀
STC-FL-343-Pico	343	1-50	100-900	0.1-20 (variable)	Pulsed	TEM ₀₀
STC-FL-355-Pico	355	1-50	100-900	0.1-20 (variable)	Pulsed	TEM ₀₀
STC-FL-515-Pico	515	1-1000	100-900	0.1-20 (variable)	Pulsed	TEM ₀₀
STC-FL-532-Pico	532	1-1000	100-900	0.1-80 (variable)	Pulsed	TEM ₀₀
STC-FL-535-Pico	535	1-1000	100-900	0.1-20 (variable)	Pulsed	TEM ₀₀
STC-FL-1030-Pico	1030	10-5000	100-900	0.1-20 (variable)	Pulsed	TEM ₀₀
STC-FL-1064-Pico	1064	10-5000	100-900	0.1-20 (variable)	Pulsed	TEM ₀₀
STC-FL-1070-Pico	1070	10-5000	100-900	0.1-20 (variable)	Pulsed	TEM ₀₀

Diode Pumped Laser Type:

	Wavelength (nm)	Output power (mW)	Pulse duration (ps)	Rep. rate (MHz)	Operating mode	Transverse mode
STC-DPS-213-Pico	213	1-30	<50 ps	5	Pulsed	TEM ₀₀
STC-DPS-266-Pico	266	100-500	<50 ps	5	Pulsed	TEM ₀₀
STC-DPS-355-Pico	355	100-700	<50 ps	5	Pulsed	TEM ₀₀
STC-DPS-532-Pico	532	2-10 W	<50 ps	0.1-10 MHz	Pulsed	TEM ₀₀
STC-DPS-1064-Pico	1064	5-30 W	<50 ps	0.1-10 MHz	Pulsed	TEM ₀₀

Picosecond Pulsed Diode Laser

Picosecond pulsed diode laser features with integrated electronics, narrow pulse duration, high repetition frequency and easy operation. It is widely used in fluorescence excitation, time resolve spectrum, high sensitive absorption spectroscopy, etc.



Model	Output power	Rep. rate (MHz)	Pulse duration (ps)
STC-MDL-PS-405	10 μW~0.5 mW	0.1~80	100-1000
STC-MDL-PS-450	10 μW~0.5 mW	0.1~80	100-1000
STC-MDL-PS-640	50 μW~3.5 mW	0.1~80	100-1000
STC-MDL-PS-655	20 μW~1.5 mW	0.1~20	100-1000
STC-MDL-PS-785	70 μW~4.2 mW	0.1~80	100-1000
STC-MDL-PS-808	90 μW~6.0 mW	0.1~80	100-1000
STC-MDL-PS-852	10 μW~1.0 mW	0.1~80	100-1000
STC-MDL-PS-940	20 μW~1.5 mW	0.1~80	100-1000
STC-MDL-PS-980	20 μW~1.5 mW	0.1~80	100-1000

UV 375nm Diode Lasers

We offer UV diode lasers at the laser wavelength of 375nm with maximum laser power 200mW. These lasers are widely used in scientific, medical, industrial and entertainment applications.

- Laser power is stable and adjustable
- Protected with overheating and over current
- Can be externally controlled with high speed modulation
- Suitable for scientific research, medical treatment, biological engineering, stage laser show, etc



List of UV Diode Lasers

Part Number	Wavelength	Laser Power
ST-I-DC-375-20	375nm	20mW
ST-I-DC-375-50	375nm	50mW
ST-I-DC-375-100	375nm	100mW
ST-I-DC-375-150	375nm	150mW
ST-I-DC-375-200	375nm	200mW

Detailed Specifications

Part Number	ST-I-DC-375-xxx
Wavelength (nm)	375
Operation Mode	CW
Beam Mode	TEM00
Output Power (mW)	20/50/100/150/200
Average Power Stability (Over 4hrs)	<1%/<3%/<5%
Beam Divergence (full angle, mrad)	1.2
Beam Diameter at Aperture (mm)	<1.5
Beam Height from Base Plate	27
Warm-up Time (min)	<10
Cooling	Air
Operation Tem. (°C)	15-35
Power Supply	ST-IIA(GT1)/ST-OEM-B(GT1)
Expected Lifetime (hrs)	10,000
Laser Head Dimension (mm)	136x50x47
Laser Head Weight (kg)	0.5
Power Supply Dimension (mm)	168x164x80/149x80.5x49
Power Supply Weight (kg)	1.5/0.5

Remarks: 1) In the part number, xxx means laser power in mW; 2) Other power levels available upon request; 3) There are 3 average power stabilities for all lasers and default is 5%; 4) There are 2 types of power supplies: integrated and OEM. The power input of integrated is 110V-220VAC and the power input of OEM is 12VDC.

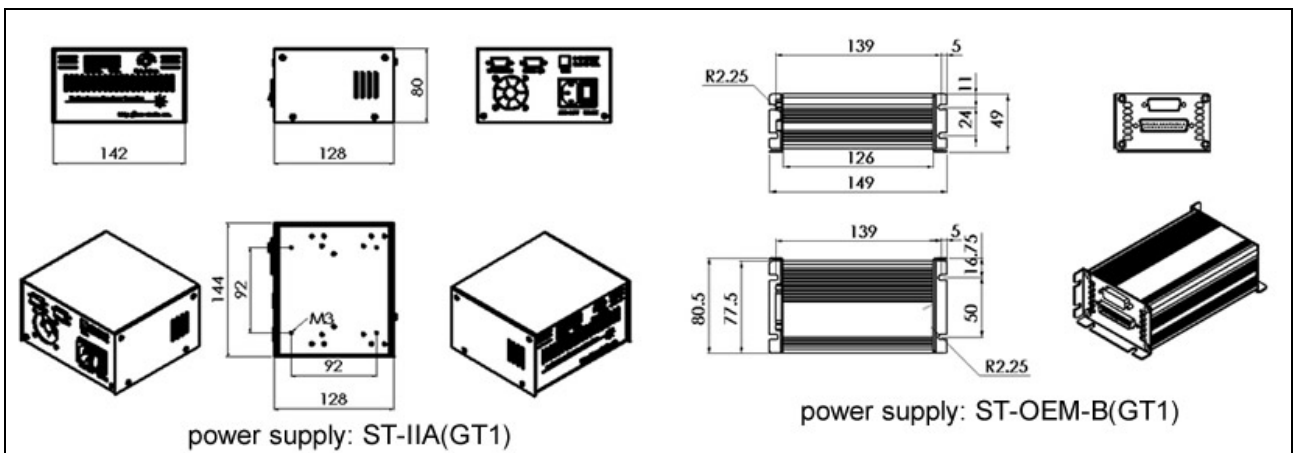
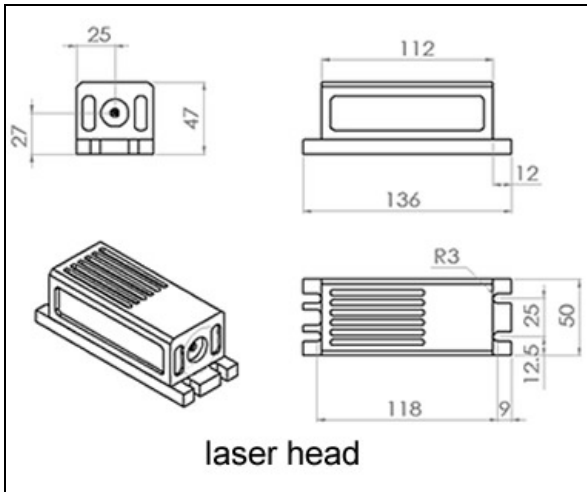

UV-IR Laser Diode Modules

1. Multi-mode Fiber Output

- Good power stability with temperature control
- Various fiber connectors for your selection
- Good consistency for fiber connection in/out
- Custom-design available



Wavelength(nm)	Laser power	Power stability (peak-peak)	Core diameter	Fiber connector
375+/-5nm	0-160 mW	<3%	100um,200um,400um,.....	FC/PC,SMA905,.....
405+/-5nm	0-1W	<3%	100um,200um,400um,.....	FC/PC,SMA905,.....
445+/-5nm	0-10W	<3%	100um,200um,400um,.....	FC/PC,SMA905,.....
450+/-5nm	0-10W	<3%	100um,200um,400um,.....	FC/PC,SMA905,.....
462+/-5nm	0-1000mW	<3%	100um,200um,400um,.....	FC/PC,SMA905,.....
488+/-5nm	0-160mW	<3%	100um,200um,400um,.....	FC/PC,SMA905,.....
515+/-5nm	0-30 mW	<3%	100um,200um,400um,.....	FC/PC,SMA905,.....
520+/-5nm	0-800mW	<3%	100um,200um,400um,.....	FC/PC,SMA905,.....
532+/-1nm	0-300mW	<3%	100um,200um,400um,.....	FC/PC,SMA905,.....
635+/-5nm	0-3W	<3%	100um,200um,400um,.....	FC/PC,SMA905,.....
638+/-5nm	0-3W	<3%	100um,200um,400um,.....	FC/PC,SMA905,.....
658+/-5nm	0-3 W	<3%	100um,200um,400um,.....	FC/PC,SMA905,.....
680+/-5nm	0-600mW	<3%	100um,200um,400um,.....	FC/PC,SMA905,.....
690+/-5nm	0-600mW	<3%	100um,200um,400um,.....	FC/PC,SMA905,.....
730+/-5nm	0-1300 mW	<3%	100um,200um,400um,.....	FC/PC,SMA905,.....
750+/-5nm	0-1300 mW	<3%	100um,200um,400um,.....	FC/PC,SMA905,.....
760+/-5nm	0-1300 mW	<3%	100um,200um,400um,.....	FC/PC,SMA905,.....
780+/-5nm	0-3W	<3%	100um,200um,400um,.....	FC/PC,SMA905,.....
790+/-5nm	0-1500mW	<3%	100um,200um,400um,.....	FC/PC,SMA905,.....
808+/-5nm	0-20W	<3%	100um,200um,400um,.....	FC/PC,SMA905,.....
830+/-5nm	0-1500mW	<3%	100um,200um,400um,.....	FC/PC,SMA905,.....
850+/-5nm	0-1500mW	<3%	100um,200um,400um,.....	FC/PC,SMA905,.....
880+/-5nm	0-2W	<3%	100um,200um,400um,.....	FC/PC,SMA905,.....
905+/-5nm	0-100 mW	<3%	100um,200um,400um,.....	FC/PC,SMA905,.....
915+/-5nm	0-10W	<3%	100um,200um,400um,.....	FC/PC,SMA905,.....
940+/-5nm	0-20W	<3%	100um,200um,400um,.....	FC/PC,SMA905,.....
980+/-5nm	0-20W	<3%	100um,200um,400um,.....	FC/PC,SMA905,.....
1064+/-5nm	0-10W	<3%	100um,200um,400um,.....	FC/PC,SMA905,.....
1310+/-20nm	0-600 mW	<3%	100um,200um,400um,.....	FC/PC,SMA905,.....
1470+/-20nm	0-2000 mW	<3%	100um,200um,400um,.....	FC/PC,SMA905,.....
1550+/-20nm	0-1300 mW	<3%	100um,200um,400um,.....	FC/PC,SMA905,.....
1870+/-20nm	0-500mW	<3%	100um,200um,400um,.....	FC/PC,SMA905,.....
1940+/-20nm	0-500mW	<3%	100um,200um,400um,.....	FC/PC,SMA905,.....
2200+/-20nm	0-300mW	<3%	100um,200um,400um,.....	FC/PC,SMA905,.....

Ordering Information

STX-XXX-YYY-PPP-MM-DDD-CCC-LLL

- STX means STX series fiber-coupled laser diode modules
- XXX means laser wavelength in nm.
- PPP means the output laser power from the fiber
- MM means fiber type, that is single mode (SM) or multi mode (MM)
- DDD means package type, that is 50FC, 75FC, 80FC or T7. (1) 50FC: 35x35x102mm, individual driver with temp control. (2) 75FC: 49x42x140mm, individual driver with temp. control. (3) 80FC: 49x52x140mm, individual driver with temp. control. (4) T7: 49x42x140mm, laser head and driver assembled together with temp. control, 5VDC input required.
- CCC means core diameter, such as 50, 100, 200, 400um.....
- LLL means fiber length in meter.

All the lasers can be made with any one of 4 packages. In general, the laser with <3W is matched with driver 1805 and others is matched with driver 1860.

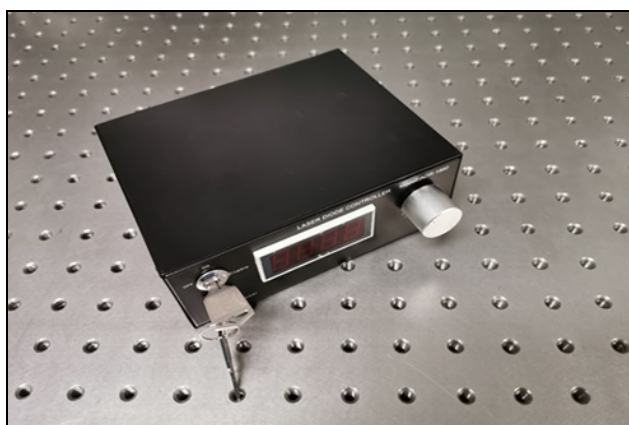

Driver 1860: 90-240VAC, adjustable current, TTL modulation >10kHz, 150x120x58mm

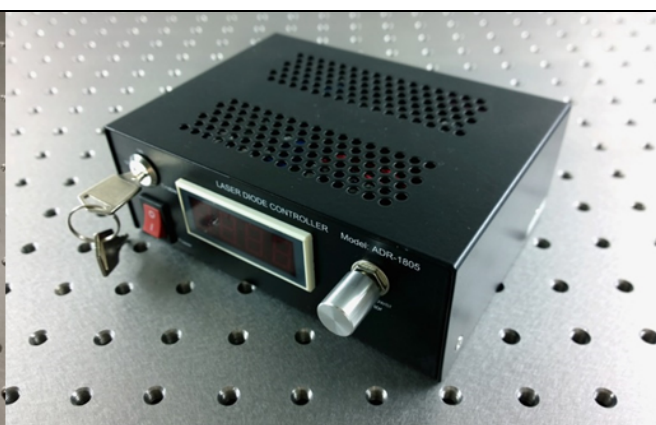

Driver 1805: 90-240VAC, adjustable current, TTL modulation >50kHz, 150x110x56mm

2. Single Mode Fiber Output

Wavelength(nm)	Laser power	Power stability (peak-peak)	Fiber connector	Extinction ratio
375+/-5nm	0-20 mW	<3%,<5%	FC/PC,FC/APC,SMA...	>17dB
405+/-5nm	0-80 mW	<3%,<5%	FC/PC,FC/APC,SMA...	>17dB
445+/-5nm	0-50 mW	<3%,<5%	FC/PC,FC/APC,SMA...	>17dB
455+/-5nm	0-50 mW	<3%,<5%	FC/PC,FC/APC,SMA...	>17dB
473+/-5nm	0-50 mW	<3%,<5%	FC/PC,FC/APC,SMA...	>17dB
488+/-5nm	0-30 mW	<3%,<5%	FC/PC,FC/APC,SMA...	>17dB
510+/-5nm	0-15 mW	<3%,<5%	FC/PC,FC/APC,SMA...	>17dB
520+/-5nm	0-40 mW	<3%,<5%	FC/PC,FC/APC,SMA...	>17dB
532+/-1nm	0-50 mW	<+/-5%	FC/PC,FC/APC,SMA...	>17dB
633+/-5nm	0-50 mW	<3%,<5%	FC/PC,FC/APC,SMA...	>17dB
638+/-5nm	0-80 mW	<3%,<5%	FC/PC,FC/APC,SMA...	>17dB
648+/-5nm	0-70 mW	<3%,<5%	FC/PC,FC/APC,SMA...	>17dB
658+/-5nm	0-70 mW	<3%,<5%	FC/PC,FC/APC,SMA...	>17dB
685+/-5nm	0-25mW	<3%,<5%	FC/PC,FC/APC,SMA...	>17dB
690+/-5nm	0-15 mW	<3%,<5%	FC/PC,FC/APC,SMA...	>17dB
705+/-5nm	0-20 mW	<3%,<5%	FC/PC,FC/APC,SMA...	>17dB
730+/-10nm	0-20 mW	<3%,<5%	FC/PC,FC/APC,SMA...	>17dB
780+/-5nm	0-80 mW	<3%,<5%	FC/PC,FC/APC,SMA...	>17dB
785+/-5nm	0-80 mW	<3%,<5%	FC/PC,FC/APC,SMA...	>17dB
808+/-3nm	0-150 mW	<3%,<5%	FC/PC,FC/APC,SMA...	>17dB
830+/-5nm	0-80 mW	<3%,<5%	FC/PC,FC/APC,SMA...	>17dB
850+/-5nm	0-20 mW	<3%,<5%	FC/PC,FC/APC,SMA...	>17dB
915+/-5nm	0-50 mW	<3%,<5%	FC/PC,FC/APC,SMA...	>17dB
940+/-5nm	0-80 mW	<3%,<5%	FC/PC,FC/APC,SMA...	>17dB
973+/-3nm	0-350 mW	<3%,<5%	FC/PC,FC/APC,SMA...	>17dB
976+/-3nm	0-500 mW	<3%,<5%	FC/PC,FC/APC,SMA...	>17dB
1064+/-10nm	0-100 mW	<3%,<5%	FC/PC,FC/APC,SMA...	>17dB
1310+/-20nm	0-150 mW	<3%,<5%	FC/PC,FC/APC,SMA...	>17dB
1550+/-20nm	0-150 mW	<3%,<5%	FC/PC,FC/APC,SMA...	>17dB

Ordering Information

STX-XXX-YYY-PPP-MM-DDD-CCC-LLL

- STX means STX series fiber-coupled laser diode modules
- XXX means laser wavelength in nm.
- PPP means the output laser power from the fiber

10 Bukit Batock Crescent #07-02 The Spire Singapore 658079 Tel: 6316 7112 Fax: 63167113
<http://www.SintecOptronics.com> <http://www.sintec.sg> sales@sintec.sg sales@SintecOptronics.com

- MM means fiber type, that is single mode (SM) or multi mode (MM)
- DDD means package type, that is T, T2 or T7. (1) T: 35x35x102mm, individual driver with temp control. (2) T2: 49x42x140mm, individual driver with temp. control. (3) T7: 49x42x140mm, laser head and driver assembled together with temp. control, 5VDC input required.
- CCC means core diameter, such as 50, 100, 200, 400um.....
- LLL means fiber length in meter.

All the lasers can be made with any one of 3 packages and only one driver 1805 is used.