

STYA Series Laser Diode Drivers



The series of the diode laser power supply introduced by our company has the advantages of ultra-low current ripple, ultra-low temperature drift, high stability and high reliability. The power supply adopts PWM conversion technology and the overall conversion efficiency is very high. The power supply can be controlled by the front panel operation, or by external devices through the external control interface, and also can be connected to a computer through the RS232 interface for remote control. We fully consider the laser diode LD protection measures with over current, over voltage, over temperature and anti-static protection functions. The power supply has emergency termination laser output function and operation button.

This series of power supplies are divided into external type WZ, built-in type NZ, laboratory type SY (desktop), TT type which can be used independently on the table or integrated into the system, and WK type which is only used for drive a TEC cooler for temperature control. And the output drive and control are diode drive, one or two TEC temperature control, acousto-optic Q-switch control. Also our company can customize all kinds of diode driver according to the specific needs of customers.

Part number	Input power	LD Max output	Max output of temperature control	Dimension
STYA-12V12A-1T-SY	220VAC	12.5V/12A	15V/12A	160*320*110
STYA-03V10A-TT	220VAC	3.5V/10A		145*260*83
STYA-03V20A-TT	220VAC	3.5V/20A		145*260*83
STYA-03V30A-TT	220VAC	3.5V/30A		145*260*83
STYA-03V40A-TT	220VAC	3.5V/40A		145*260*83
STYA-03V50A-TT	220VAC	3.5V/50A		145*260*83
STYA-03V60A-TT	220VAC	3.5V/60A		145*260*83
STYA-09V25A-TT	220VAC	9.5V/25A		145*260*83
STYA-12V20A-TT	220VAC	12.5V/20A		145*260*83
STYA-16V16A-TT	220VAC	16.5V/16A		145*260*83
STYA-20V13A-TT	220VAC	20.5V/13A		145*260*83
STYA-25V10A-TT	220VAC	25.5V/10A		145*260*83
STYA-30V08A-TT	220VAC	30.5V/8A		145*260*83
STYA-03V75A-1T-WZ	220VAC	3.3V/75A	22V/15A	483*425*133
STYA-06V50A-2T-Q-WZ	220VAC	6V/50A	12V/10A+Q control	483*425*133
STYA-9V100A-WZ	220VAC	9.5V/100A		483*350*89
STYA-12V80A-WZ	220VAC	12.5V/80A		483*350*89
STYA-15V60A-WZ	220VAC	15.5V/60A		483*350*89
STYA-20V50A-WZ	220VAC	20.5V/50A		483*350*89
STYA-25V40A-WZ	220VAC	25.5V/40A		483*350*89
STYA-30V30A-WZ	220VAC	30.5V/30A		483*350*89
STYA-15V15A-WK			15V/15A	160*320*110

1. Diode laser drive STYA-12V12A-1T-SY



STYA-12V12A-1T-SY diode laser driver (hereinafter referred to as "power supply") is one of the laboratory-use (desktop) series of power supplies launched by our company. The characteristics of this series of power supplies are ultra-low current ripple, ultra-low temperature drift, high stability and high reliability. The power supply adopts PWM conversion technology, the overall conversion efficiency is very high. The power supply can be controlled by the front panel operation, or by external devices through the external control interface, and also can be connected to a computer through the RS232 interface for remote control. The power supply design fully considers for the laser diode LD protection measures with over current, over voltage, over temperature and anti-static protection functions. The power supply has emergency termination laser output function and operation button. The front panel of the power supply is designed with local/remote, internal control/external control switch, that is convenient for users to switch to various control modes. Its display screen can display set current, measured current, measured temperature, limit current parameters. At the same time, a data storage unit is designed inside the power supply, which can store power status parameters at any time. The power supply has a limit current setting function. When the limit current is set, the set current during power operation will not exceed the limit value under any circumstances. The power supply has real-time detection and display function of LD temperature, and the control temperature of LD can be adjusted through the front panel. The front panel of the power supply is also designed with a variety of status indicator LED, convenient for users to know the state of power supply. The power supply can also provide an external control interface (DB15) on the rear panel to control external devices, so as to set the current value and start/stop the current operation. The external control interface can also provide real-time current detection signals, power failure signals, and interlock signals of external devices. When the power supply is in the remote control status, the host computer can set the current value of the power supply, the current start/stop operation, query the power supply parameters at any time, accept the power upload information.

The main features are as follows:

- Set laser diode LD drive and TEC temperature control as a whole
- Local control and computer remote control are optional
- With external control interface, support external device control
- High efficiency, high precision and high reliability
- Ultra-low current ripple, ultra-low temperature drift
- Current start zero overshoot, current close zero recoil
- Complete over current, over voltage, over temperature and anti-static protection function
- Automatic memory function, at any time to store various power parameters
- With the function of setting current and limiting current setting
- LD temperature setting function
- Interlock signal interface for external equipment
- Key switch, emergency stop switch function
- Full metal housing with zero external radiation interference

Main technical parameters:

Input power	AC220V±20% 50±3Hz
Output voltage (LD)	3~12.5V self adaptive load
Output current (LD)	0.1~12A continuous adjustable
Power conversion efficiency	≥85%
Current instability	≤±0.2%
Current noise	≤0.3%
Current starts over impulse	0%
Current turns off the back impulse	0%
Current starts rising edge	100mS
Current off falling edge	0.1mS
Temperature controlled drive capability	15V/12A
Temperature control precision	≤±0.01℃
Operation environment	Temperature: -10~+50℃ ; Humidity: <85%
Storage environment	Temperature: -30~+85℃ ; Humidity: <90%
Dimensions	160*320*110 (mm)
Weight	5kg

2. Diode laser drive power STYA-16V16A-TT

STYA-16V16A-TT diode laser drive (hereinafter referred to as "power supply") is one of the series LD drive power supplies launched by our company. This series of power supply has the features: can be completely independent use, also can be easily integrated into the system. The power supply adopts PWM control technology and our company's core patent technology, with the overall conversion efficiency is very high, low current ripple, low temperature drift characteristics. The power supply can be either controlled locally by the front panel or through the external control interface, or controlled remotely by the computer. When the front panel is used for control, the power supply also has the function of limiting current setting and automatic storage of power supply parameters. If the power supply is to be integrated into the system or controlled by external devices, just put the "internal control/external control" toggle switch in the "external control" position and then control through the external control interface (DB15). And power supply support computer remote control, through the RS232 interface can realize the setting of current size, current start and stop operation, at any time to query the power of various state parameters, accept all kinds of information uploaded by the power supply. The power supply is designed with the interlocking signal interface of external equipment, which is convenient to realize the interlocking between the power supply and external equipment (water cooler, etc.) under any control mode. The drive current output interface of the power supply can be selected in two ways: 1. Terminal mode, suitable for users of laboratory or integrated systems; 2. Aviation plug mode, suitable for power supply and solid state laser and other relatively fixed connection users.

The main features are as follows:

- Full digital design, compact structure, excellent performance
- It can be used independently or integrated into the system
- Local control and computer remote control are optional
- With external control interface, support external device control
- High efficiency, high precision and high reliability
- Ultra-low current ripple, ultra-low temperature drift

- Current start zero overshoot, current close zero recoil
- Complete over current, over voltage, over temperature and anti-static protection function
- With automatic memory function, it can store various parameters of power supply at any time
- It has the function of limiting current setting
- Interlock signal interface for external equipment
- There is a key switch to prevent unqualified personnel from opening
- Full metal housing with zero external radiation interference

Main technical specifications:

Input power	AC220V±20% 50±3Hz
Output voltage	3~16.5V Self adaptive load
Output current	0.1~16A Continuous adjustable
Max output power	260W
Power conversion efficiency	≥87%
Current instability	≤±0.3%
Current noise	≤0.3%
Temperature drift	≤20 ppm
Current starts over impulse	0%
Current turns off the back impulse	0%
Current starts rising edge	default 100ms (10~5000ms optional)
Current off falling edge	0.1ms
Work environment	Temperature: -10~+50°C; Humidity: <85%
Storage environment	Temperature: -30~+85°C; Humidity: <90%
Dimensions	145*260*83mm
Weight	3Kg

List of STYA-16V16A-TT (260W) series LD drivers

Part number	Max output voltage (V)	Max output current (A)	Output current instability	Current noise (Ap-p)	Current on up rise time (ms)	Current off fall time (ms)	Power conversion efficiency
STYA-09V25A-TT	3-9.5V	25A Continuous adjustable	≤±0.3%	≤0.3%	default 100ms 10-1000ms	0.1ms	≥85%
STYA-12V20A-TT	3-12.5V	20A Continuous adjustable	≤±0.3%	≤0.3%	default 100ms 10-1000ms	0.1ms	≥86%
STYA-16V16A-TT	3-16.5V	16A Continuous adjustable	≤±0.3%	≤0.3%	default 100ms 10-1000ms	0.1ms	≥87%
STYA-20V13A-TT	3-20.5V	13A Continuous adjustable	≤±0.3%	≤0.3%	default 100ms 10-1000ms	0.1ms	≥87%
STYA-25V10A-TT	3-25.5V	10A Continuous adjustable	≤±0.3%	≤0.3%	default 100ms 10-1000ms	0.1ms	≥87%
STYA-30V08A-TT	3-30.5V	8A Continuous adjustable	≤±0.3%	≤0.3%	default 100ms 10-1000ms	0.1ms	≥88%

3. Diode laser drive power STYA-06V50A-2T-Q-WZ

STYA-06V50A-2T-Q-WZ diode laser driver power supply (hereinafter referred to as the "Power supply") is designed for LD pumped solid state laser driver, to provide the solid state laser pump source and Q switch required RF signal. At the same time, the power supply also provides TEC temperature control circuit for LD and octave crystal. The TTL pulse generation circuit with adjustable pulse width and frequency and TTL pulse control circuit are designed inside the power supply. The power supply has the conversion function of Q-drive internal control and external control. In Q-drive internal control, TTL pulse and its control are provided by the power supply. In Q-drive external control, TTL pulses and their control are provided by external devices. The power supply also has the function of current internal control and external control conversion, in the current internal control, the power supply current setting and start and stop are operated by the front panel touch screen and other corresponding keys; In current external control, the value of the power supply current is set by the analog signal of the external device, and the start and stop of the current are controlled by the TTL signal of the external device. The power supply has the remote control function, through the RS232 interface and the remote computer communication, can set the current size of the power supply, current start and stop operations, at any time to query the power of various state parameters, accept all kinds of information uploaded by the power supply. The power supply is designed with five common output modes and storage functions. Users can set and store parameters such as current size, pulse width and pulse frequency in common modes in advance, which is convenient for users to operate quickly. The power supply has automatic storage function, the current parameters of the power supply can be stored at any time, and the power will automatically enter the mode of last use when the power is turned on next time. The power supply will also automatically store the user's usage information, so as to query at any time. The design of each link of the power supply has fully considered the requirements of the laser equipment related safety standards, in line with the safety indicators.

The main features are as follows:

- Full digital design, compact structure, excellent performance
- Built-in one LD drive, two TEC temperature control
- Built-in TTL pulse generator circuit
- Built-in Q driver and its power supply
- 65K true color LCD display, touch screen control
- Local control and computer remote control optional
- With external control interface, support external device control
- High efficiency, high precision and high reliability
- Ultra-low current ripple, ultra-low temperature drift
- Current start zero overshoot, current close zero recoil
- Complete over current, over voltage, over temperature and anti-static protection

Main technical specifications:

Input power	AC220V±20% 50±3Hz
Output voltage (LD)	0~6.0V Self adaptive load
Output current (LD)	0.1~ 50A Continuous adjustable
Power conversion efficiency	≥85%
Current instability	≤±0.2%
Current noise	≤0.3%
Temperature drift	≤ 20ppm
Current starts over impulse	0%
Current turns off the back impulse	0%
Current starts rising edge	default 100ms
Current off falling edge	0.1mS
TTL pulse width	0.5-10 (us) optional
TTL pulse frequency	1 ~ 100 (kHz) optional
LD Temperature controller drive	12V/10A
LD temperature control accuracy	≤ ±0.1℃
Laser head temperature control drive	12V/10A
Temperature control accuracy of laser head	≤±0.1℃
Operation environment	Temperature: -10~+50℃; Humidity: <90%
Storage environment	Temperature: -20~+85℃; Humidity: <95%
Dimensions	483*425*133(mm)
Weight	12kg

External fuse tube	10A
--------------------	-----

4. Temperature controller STYA-15V15A-WK



STYA-15V15A-WK temperature controller (hereinafter referred to as: temperature control power supply) is a high precision temperature control power supply with fast response, which is designed based on PWM modulation theory, including complete PID algorithm. The actuator of the temperature control power supply is a semiconductor refrigerator (TEC), and the temperature detection device is a thermistor NTC10K. The temperature control power supply supports two-way cooling and heating control. Temperature control power can be controlled through the front panel of the man-machine interface (local), easy to operate. On the front panel, you can set the temperature parameters of the controlled object, display the real-time temperature detection, start and stop the temperature control power, and display the status information of the temperature control power. And temperature control power can also be remotely controlled by computer through RS232 interface. In remote control mode, you can set temperature parameters of the temperature control power supply, query real-time temperature and various status information at any time, start and standby operations of the temperature control power supply, and receive fault information uploaded by the temperature control power supply. The temperature control power supply has the automatic memory function, which will automatically store the related setting parameters. Temperature control power adopts low noise, portable structure design, touch screen and physical keys shared operation scheme.

The main features:

- Digital design, excellent performance
- Local control and computer remote control optional
- 64K true color LCD display, touch screen control
- Complete PID feedback algorithm, PWM modulation mode
- Two-way temperature control, support heating and cooling
- Supports NTC10K temperature sensor
- High efficiency, high precision and high reliability
- Automatic memory function, store various state parameters at any time
- Real-time temperature display and alarm prompt function
- Simple and quick man-machine interface
- Low noise structure design

input power	AC220V±20% 50±3Hz
Output voltage range	-15~+15V (Adaptive thermal load)
Max driving current	15A
Overall conversion efficiency	≥85%
Temperature setting Range	1~99℃
Temperature control range	-10~110℃
Temperature control accuracy	≤±0.01℃
Starting current is over impulse	0%
Temperature sampling device	NTC10K@25℃, B=3950

Operation environment	Temperature: -10~+50°C; Humidity: <85%
Storage environment	Temperature: -30~+85°C; Humidity: <90%
Dimensions	160*320*110 (mm)
Weight	3Kg
External fuse tube	5A

SYL Series Diode Laser Modular Drivers

SYL series diode drivers are designed as individual modules and they are very easily integrated into the user's power supply or control systems. These modules are DC/DC current-constant output or AC/DC voltage-constant plus DC/DC current-constant output. The user can design his own display to show the driving current, voltage, temperature etc. Our drive modules are widely used in laser diodes, diode chips, LEDs and fiber lasers.



We have the following 5 special technologies:

- 1) Three-phase Active Power Factor Correction Technology
 - Improve electro-magnetic compatibility and solve the problem of "CE101"
 - High power factor as 0.9998
 - Small harmonic distortion, THD \leq 3%
- 2) Digital Power Technology
 - Parameters changeable online
 - Easily modular design
 - Remote monitor on communication ports
- 3) Magnetic Integration Technology
 - Reduce the size of transformer & inducer and inductance leakage
 - Increase power density and conversion efficiency
 - Improve parts characteristics and consistency
- 3) Resonant Half-bridge/full-bridge Soft-switching Conversion Technology
 - Small switching loss
 - High conversion efficiency
 - Small magnetic interference
- 4) High Power Current-constant & Parallel Current Sharing Technology
 - Current adjustable
 - Small current tolerance as low as 1% or smaller
- 5) Anti-interference Technology in RF Environment
 - Effective anti-interference control via individual stages and frequencies
 - Strong environment adaptability

List of Often-used Laser Diode Modules

Product name	Part number	Output power W	Output voltage/current V/A	Power input	Dimension mm
DC/DC diode drive module	SYL-YDF*V*A130D	512-1400	34V/20A; 34V/25A; 68V/20A; 68V25A	80-130VDC	119.5*63.5*13.0
DC/DC diode drive module	SYL-YBN*V*A130D	1500-3200	72V/25A; 130V/25A; 130V30A	110~140VDC 185~215VDC	160*63*30
DC/DC diode drive module	SYL-YBN30V20A34D	600	12-30V/20A	22-38VDC	70.7*36.2*12.5
DC/DC diode drive module	SYL-YLN68V22A72D	672-1200	16-70V/0-26A	20-74VDC	91*43*16
DC/DC diode drive module	SYL-YLN78V3900W80D	3900	78-83V/0-25A*2 2-channel output	79-85VDC	144*88*16.8
DC/DC diode drive module	SYL-YLN78V8KW80D	6000-8800	58-88V/0-25A*4 4-channel output	60-90VDC	280*120*30
DC/DC diode drive module	SYL-YLN83V12KW85D	9000-13000	58-88V/0-25A*6 6-channel output	60-90VDC	396*120*41
All-in-one diode driver module	SYL-YAN78V5000W220A	3600-5000	45V/0~30A*3 3-channel output; 56V/0~30A*3 3-channel output; 80V/0~30A*2 2-channel output; 56~85V/0~30A*3 3-channel output	176-264VAC	386*355*51.5
All-in-one diode driver module	SYL-YS83V10KW380Y-JG	10000	72-78V/0-25A*4 4-channel output	323-437VAC	580*422*120

1. DC/DC diode drive module, switching current-constant output, power 512~1400W

- Part model: SYL-YDF*V*A130D
- Outlook dimension: 119.5*63.5*13.0mm (L*W*H)
- Input voltage 80~130VDC
- Output voltage/current: 34V/20A; 34V/25A; 68V/20A; 68V25A
- Insulation voltage: 700VDC
- Conversion eff.: 90~92% (full loading)
- Protection of input over or under voltage
- Protection of output over voltage
- Protection of over current and short-circuit
- Protection of over temperature
- High efficiency and no reducing-temperature needed



2. DC/DC diode drive module, switching current-constant output, power 1500~3200W

- Part model: SYL-YBN*V*A130D
- Outlook dimension: 160mm*63mm*30mm (L*W*H)
- Input voltage 110~140VDC, 185~215VDC
- Output voltage/current, 72V/25A series; 130V/25A series; 130V30A series
- Insulation voltage: 700VDC
- Conversion eff.: 95% (full loading)
- Current rise/down time: 30uS
- Protection of input over or under voltage
- Protection of over output voltage
- Protection of over current and short-circuit
- Protection of over temperature
- CAN bus communication



3. DC/DC diode drive module, switching current-constant output, power 600W



- Part model: SYL-YBN30V20A34D
- Outlook dimension: 70.7*36.2*12.5mm (L*W*H)
- Input voltage 22~38VDC
- Output voltage/current: 12~30V/20A
- Insulation voltage: 700VDC
- Conversion eff.: 97% (full loading)
- Protection of input over or under voltage
- Protection of over output voltage
- Protection of over current and short-circuit
- Protection of over temperature
- High efficiency and no reducing-temperature needed

4. DC/DC diode drive module, linear current-constant output, power 672~1200W



- Part model: SYL-YLN68V22A72D
- Outlook dimension: 91*43*16mm (L*W*H)
- Input voltage 20~74VDC
- Output voltage/current: 16~70V/0~26A; Load voltage is 3V less than input voltage
- Protection of output over current and short circuit
- Protection of over temperature
- Current rise/down time: 15uS
- Output ripple current: 1A
- High power density and high reliability

5. DC/DC diode drive module, 2-channel linear current-constant output, power 3900W

- Part model: SYL-YLN78V3900W80D
- Outlook dimension: 144*88*16.8mm (L*W*H)
- Input voltage 79~85VDC
- Output voltage/current: 78-83V/0~25A*2
- Protection of output over current and short circuit
- Protection of over temperature
- Current rise/down time: 15uS
- Output ripple current: 500mA
- High power density and high reliability

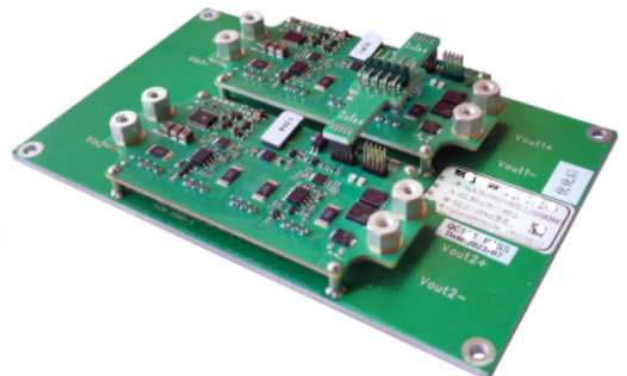

6. DC/DC diode drive module, 4-channel current-constant output, power 6kW~8.8kW

- Part model: SYL-YLN78V8KW80D
- Outlook dimension: 280*120*30mm (L*W*H)
- Input voltage 60~90VDC
- Output voltage/current: 58~88V/0~25A*4
- Protection of output over current and short circuit
- Protection of over temperature
- Current rise/down time: 10uS
- Output ripple current: 500mA
- High power density and high reliability



7. DC/DC diode drive module, 6-channel current-constant output, power 9kW~13kW



- Part model: SYL-YLN83V12KW85D
- Outlook dimension: 396*120*41mm (L*W*H)
- Input voltage 60~90VDC
- Output voltage/current: 58~88V/0~25A*6
- Protection of output over current and short circuit
- Protection of over temperature
- Current rise/down time: 10uS
- Output ripple current: 500mA
- High power density and high reliability

8. All-in-one diode driver module, linear current-constant output, power 3600-5000W



- Part model: SYL-YAN78V5000W220A
- Outlook dimension: 386*355*51.5mm (L*W*H)
- Input voltage 176~264VAC
- Output voltage/current: 45V/0~30A*3; 56V/0~30A*3; 80V/0~30A*2; 56~85V/0~30A*3
- Protection of input under voltage and over voltage
- Protection of output over current, over voltage and short circuit
- Protection of over temperature
- Current rise/down time: 20uS
- High power density and high reliability

9. All-in-one diode driver module, switching current-constant output, power 10kW



- Part model: YS83V10KW380Y-JG
- Outlook dimension: 580*422*120mm (L*W*H)
- Input voltage 323~437VAC
- Output voltage/current: 72-78V/0~25A*4
- Protection of over current and short circuit
- Protection of over temperature
- Current rise/down time: 15uS
- Output ripple current: 800mA
- High power density and high reliability

STXF Series PCB-mountable Diode Drivers

STXF series PCB mountable diode laser driver is an OEM individual module designed for driving laser diodes. It mainly includes diode laser control board/module, diode laser driving board/module and temperature control board/module. Our users can combine these three modules to form a complete diode laser power supply.

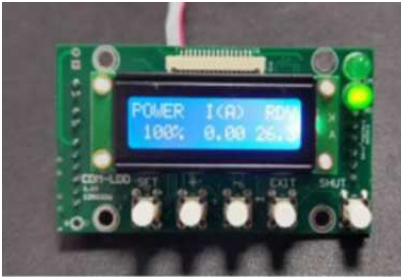

control board

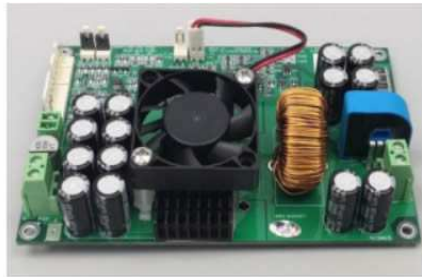

driving board



temp. control board

1. Diode Laser Control Board

The diode laser control board supports 1 channel of the diode laser (LD) driving board and 1 channel of temperature control board manufactured by our company. Through the control board, in addition to setting and viewing the current and controlling the output of the current, it also has the functions of external control of the current and can be connected to 1 channel of the temperature control board made by our company (can be connected or not) and other functions. You can integrate this board together with LD driving board and temperature control board to form a complete diode laser power supply system. The display board is easily to be integrated and can be directly installed on panels of a 2U chassis.

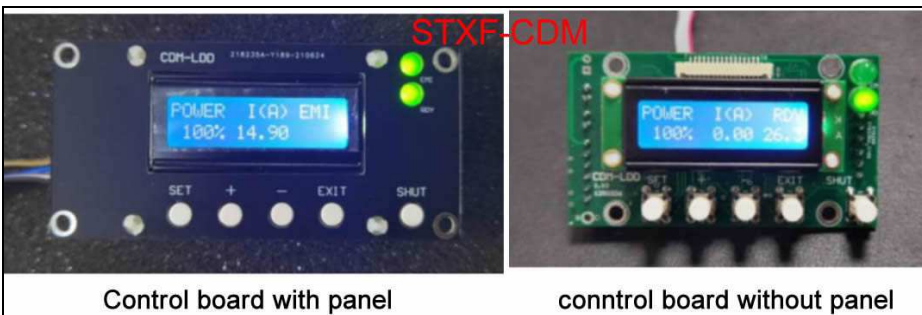

Control board with panel

control board without panel

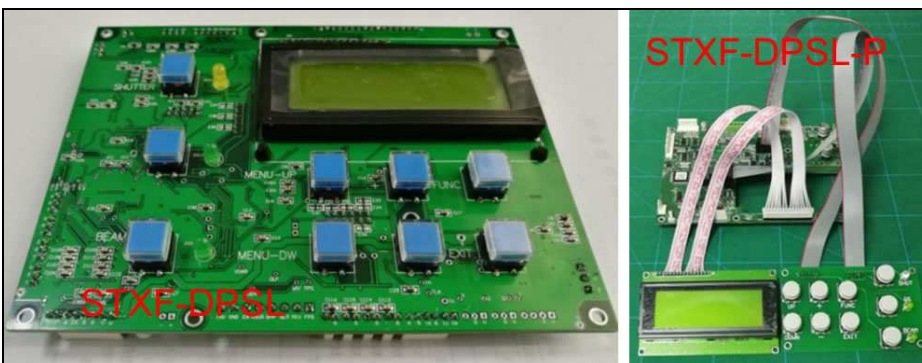

STXF-DPSL

STXF-DPSL-P

Features:

- It can be easily installed on the customer's equipment panel in a minimum 2U chassis
- STXF-CDM supports 1 channel STXF series LD driving board and 1 channel STXF series temperature control board (TEC cooler) and STXF-DPSL supports max. 2-channel STXF series LD driving boards and max. 4-channel STXF series temperature control boards (TEC cooler)
- It has temperature interlock via temperature control board
- It has a communication protocol and can be connected to a computer and controlled by computer software

- It has INTERLOCK interface
- Current internal and external control
- Optional PWM modulation output
- Can be powered directly from the LD driving board or the temperature control board, no independent power supply required
- It is suitable for use with our PC software STXF-Mate

Applications:

- Control LD driving board and temperature control board
- Main control board of diode laser

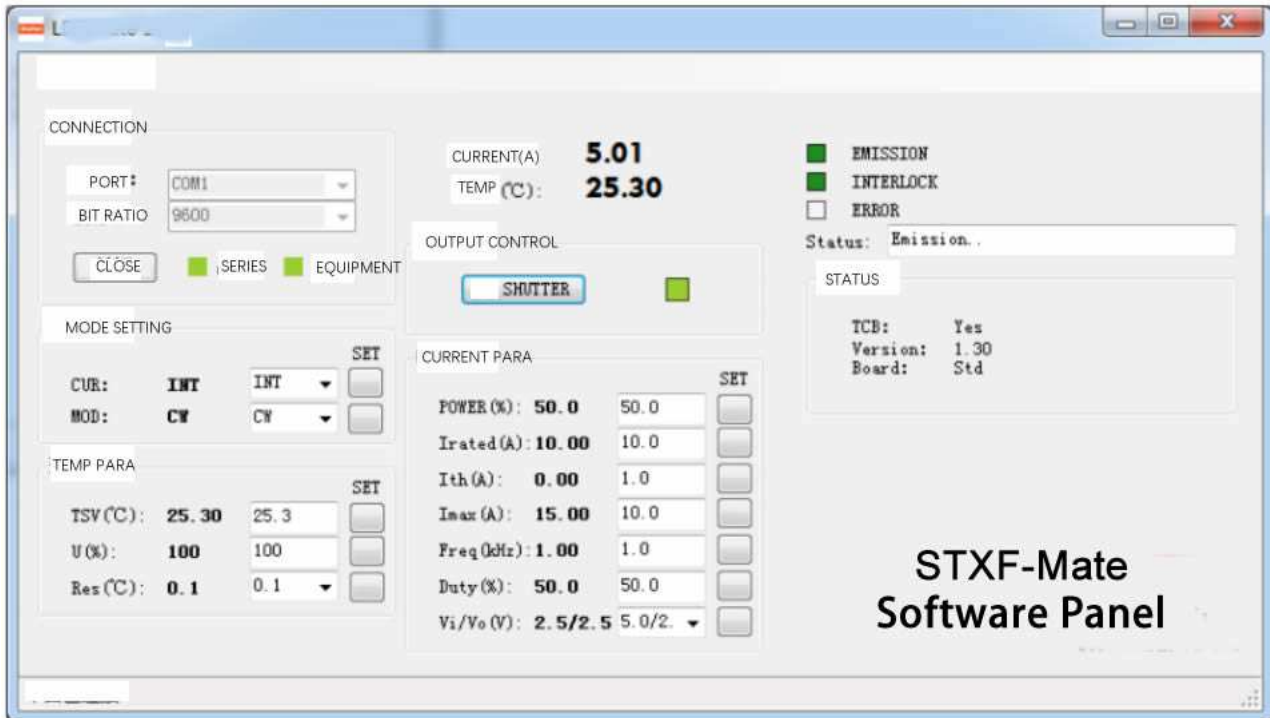

Main Technical Parameters:

- Required power input: 5VDC \pm 5% (can be powered directly from the LD driving board, or can be connected to the 6-pin IDC interface to get power from the temperature control board, or can be powered by a separate 5VDC)
- Required max. current: 0.1A
- Support LD driving board: STXF series of LD driving boards
- Support temperature control board: STXF series temperature control board
- Output PWM modulation: 0.04-500kHz
- Duty cycle: 0.1-100%
- Working ambient temperature: -40 - +60 degrees
- Storage ambient temperature: -40 - +70 degrees
- Working environment humidity: 0-95%
- Dimensions: 70mm*39mm, height 22mm (9mm above the board, 1.5mm thick, 11.5mm below the board)

Ordering Information:

- Product name: diode laser control board
- Product number: STXF-CDM-P (-P means with a black panel, or no -P means no panel); Or STXF-DPSL-P (-P means that the display and PCB board are separated and no -P means that they are integrated together.)
- For example: STXF-CDM, STXF-CDM-P

Dimensions:

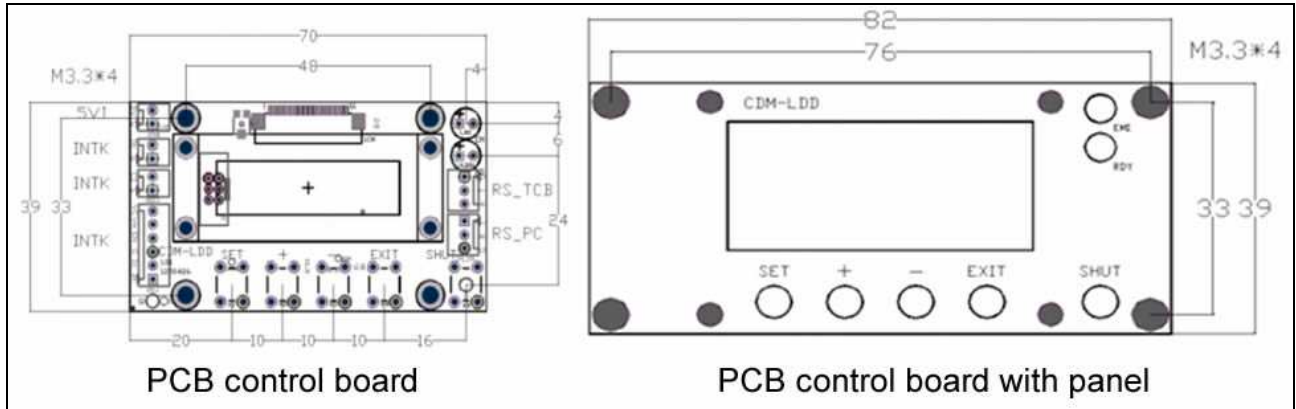

Electrical Connections:

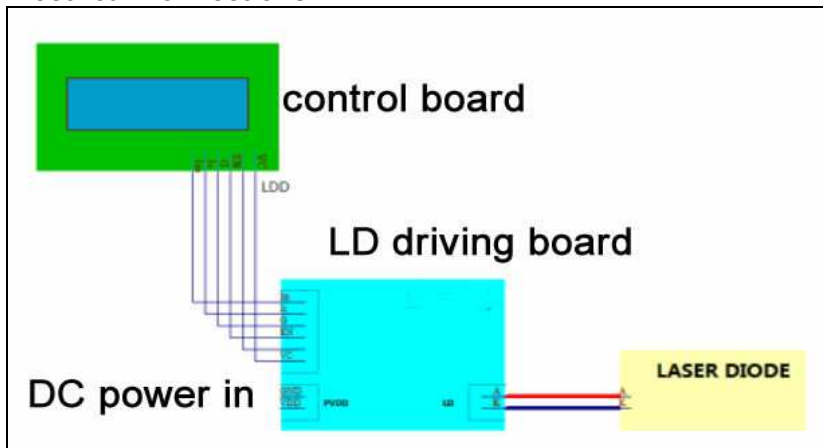

You just directly connect this board and the LD driving board by P to P via 6PIN interface.

2. Diode Laser Driving Board

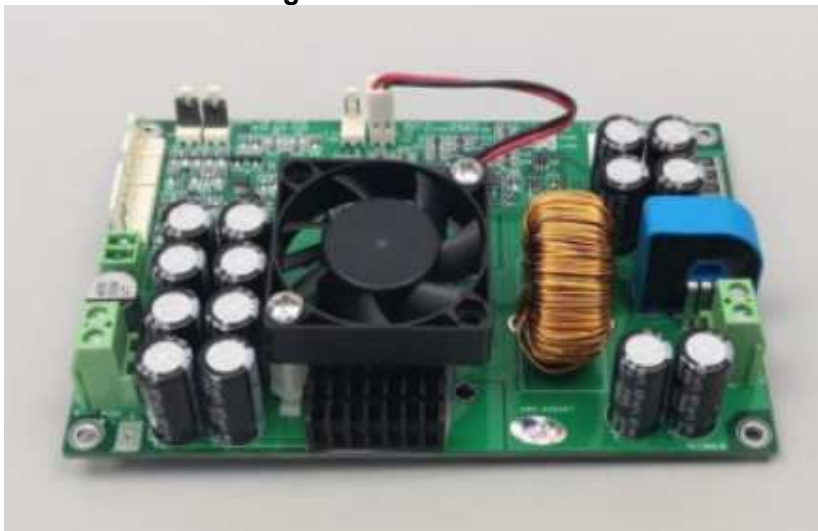

Name	Specifications	Drive capability (max)	Maximum output power (W)	Supply voltage (V)	Dimension (mm)	Features
LD driving board	STXF-LDPV-xxA	3A24V	60	12/15/24	40*56	Adaptive, no heat
LD driving board	STXF-LDXS-10A5V-TA	10A3V	30	5	60*45	Self-adaptive, no heat, small size
LD driving board	STXF-LDSS-xxA-MA	5A24V	100	12/15/24	54*70	Adaptive, no heat
LD driving board	STXF-LDDH-xxA24V-MA	15A22V	330	12/15/24	75*100	Adaptive, no heat
LD driving board	STXF-LDDH-xxA32V-MA	15A30V	420	32	75*100	Adaptive, no heat
LD driving board	STXF-LDDH-xxA36V-MA	15A34V	500	36	75*100	Adaptive, no heat
LD driving board	STXF-LDDP-xxA24V-MA	25A24V	550	12/15/24	75*100	Adaptive, no heat
LD driving board	STXF-LDDP-xxA32V-MA	20A32V	550	32	75*100	Adaptive, no heat
LD driving board	STXF-LDDH-xxA48V-MV	15A48V	650	48	85*130	Adaptive, no heat

LD driving board	STXF-LDDH-xxA60V-MV	15A60V	825	60	85*130	Adaptive, no heat
LD driving board	STXF-LDDH-xxA72V-MV	15A72V	1000	72	85*130	Adaptive, no heat
LD driving board	STXF-LDDH-xxA5.5V-MA	60A5V	300	12	85*130	Adaptive, no heat
LD driving board	STXF-LDDH-xxA5.5V-MD	100A5V	500	12	120*140	Adaptive, no heat
LD driving board	STXF-LDDC-xxA24V-MA	60A24V	1320	24	120*160	Adaptive, no heat
LD driving board	STXF-LDDC-xxA32V-MA	60A32V	1800	32	120*160	Adaptive, no heat
LD driving board	STXF-LDDC-xxA36V-MA	50A36V	1800	36	120*160	Adaptive, no heat
LD driving board	STXF-LDDC-xxA48V-MA	40A48V	1800	48	120*160	Adaptive, no heat
LD driving board	STXF-LDDC-xxA60V-MA	30A60V	1800	60	120*160	Adaptive, no heat
LD driving board	STXF-DDLS-xxA	15A24V		5~24	54*54	Fast drive, hot
DFB driving board	STXF-SDDC-x-xxA	2A2V+TEC		5	65*85	DFB laser general driver
DFB/TO driving board	STXF-SDD-10A	0.7A2V		5	50.8*50.8	DFB/TO laser fast drive, 1-20ns
DFB/TO driving board	STXF-SDD-20A	2A2V		5	50.8*50.8	DFB/TO laser fast drive, 0.3-3ns
DFB/TO temp. control board	STXF-ATC-B1	3A4.5V		5	40*40	DFB/TO laser temperature control board

Details of laser diode driving board STXF-LDDH-xxAyyV-M:

STXF-LDDH laser diode driving board (also called laser power board, constant current source board) is a new high-tech product, chip-level customization, and innovative design. It is especially suitable as a driving source for high voltage and low current laser diodes. Due to the single-board design, it is particularly easy to integrate into laser diode products. It is suitable for end pump, side pump, semiconductor/diode, optical fiber and other types of lasers that require diode laser pumping or source. Therefore, it is perfectly suitable for various applications such as diode laser welding, marking and fiber laser etc.

Features:

- Load voltage, as high as up to 70V
- Load current up to 15A
- Load voltage adaptation
- High speed, rising edge and falling edge $\leq 1\text{ms}$
- High efficiency, air cooling
- Two analog channels are optional (internal and external control, one of which is a slow interface, which can be connected to analog or potentiometer)
- The switch of channels is high-speed analog switch, which can realize the modulation function
- Separate power supply for driving and control
- Compact design for easy integration

Recommended Applications:

- End-pumped or side-pumped solid-state DPSS lasers
- Diode laser
- Fiber laser
- Products that require a constant current source for CW or pulsed applications (eg: diode laser testing, LED light emitting diode testing)
- Applications such as welding, marking, heating, product testing etc.

Main technical parameters:

- Model: STXF-LDDH-xxAyyV-MV (xx/yy is selected by customer according to requirements)
- Load Current: 15A max
- Load voltage: 70V max, at least 1V less than the supply voltage
- Rise/fall time: $\leq 1\text{ms}$
- Current ripple: $< 0.1\text{A}$
- Current temperature drift: $< 10\text{ppm}$
- Efficiency: $> 95\%$
- Input driving voltage: 48V/60V/72V optional
- Input control voltage: 12V/15V/24V (can be selected by J1 on the board)
- Control board power consumption: $\leq 1.5\text{W}$
- Current analog input: 0-5V corresponds to 0-highest current, or user specified
- Current feedback output: 0-2.5V corresponds to 0-highest current, or user specified
- Board weight: 185g
- Storage temperature: $-40\text{--}+60^\circ$
- Working temperature: $-10\text{--}+45^\circ$
- Working humidity: 0-95%

- Dimensions: 130mm*8.5mm, height 35mm (30mm on board, 1.5mm thick)

Order model requirements:

STXF-LDDH-xxAyyV-MV

- xx: indicates the factory rated current, that is the current corresponding to the highest analog input, optional value: 1-15
- yy: indicates the supply voltage, the maximum load voltage is at least 1V lower than the supply voltage, 48/60/72 can be selected
- For example: STXF-LDDH-15A48V-MV

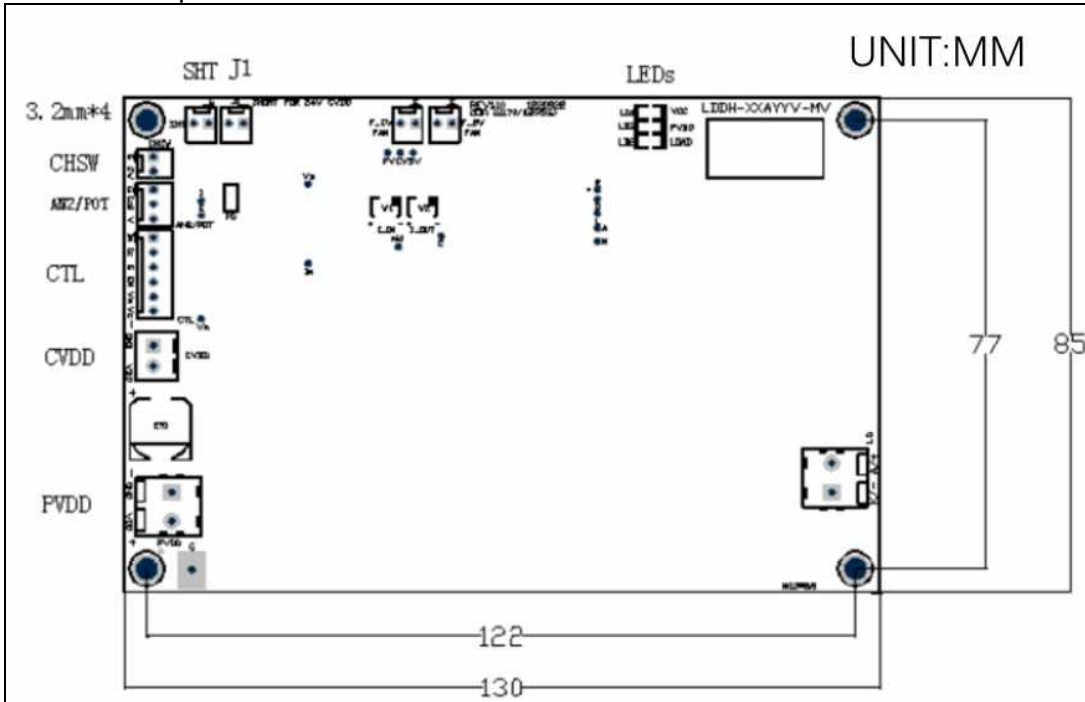

3. Temperature Control Board (TEC Driver)



Part number	Temp. stability	Driving capability (max.)	Supply voltage (V)	Size(mm)	Features
STXF-TCB-NE	0.01	10A@24V /12A@12V	5-24	75*65	Generic version, NTC
STXF-TCB-NE-PT100	0.01	10A@24V /12A@12V	5-24	75*65	PT100 version
STXF-TCB-NE-PT1000	0.01	10A@24V /12A@12V	5-24	75*65	PT1000 version
STXF-TCB-NE-AH	0.01	18A@24V /24A@12V	7-24	95*65	Generic version with enhanced power
STXF-TCB-NE-AH-PT100	0.01	18A@24V /24A@12V	7-24	95*65	PT100 version

STXF-TCB-NE-AH-PT1000	0.01	18A@24V /24A@12V	7-24	95*65	PT1000 version
STXF-TCB-NC	0.01	10A@24V /12A@12V	5-24	60*42	NE miniature version
STXF-TCB-NC-PT100	0.01	10A@24V /12A@12V	5-24	60*42	PT100 version
STXF-TCB-NC-PT1000	0.01	10A@24V /12A@12V	5-24	60*42	PT1000 version
STXF-TCB-NA	0.1	12A@24V /15A@12V	5-24	60*42	NC simplified version
STXF-TCB-SV	0.01	4.5V2.5A	7-24	60*42	Suitable for small TEC
STXF-TCB-SA	0.01	4.5V3A	5	60*42	Suitable for small TEC
STXF-TCB-SS	0.01	4.5V3A	5	40*40	SA miniature version
STXF-ATC-B1	0.001	4.4V2.8A	5	40*40	Analog PID, fast settling, DFB/TO device

Remarks: NE/NE-AH/NC use 10k NTC temperature sensor by default, PT100 or PT1000 are optional, other models only support NTC.

3,1 Details of STXF-TCB-NE-AH:

STXF-TCB-NE-AH is a temperature control board for semiconductor refrigeration chips (also known as thermoelectric coolers TEC), which contains a complete PID control. It has continuous output mode, and the temperature control accuracy can reach 0.01 degree. This device supports the most commonly used 10k NTC temperature sensor, TEC can have multiple configurations, and the power supply is DC power supply. This board is the high current version of STXF-TCB-NE. It is suitable for high-power and high-precision temperature control, such as high-power LD.

Features:

- PID control algorithm
- High accuracy, down to 0.01 degree
- Wide range of TEC voltage: 2~24V
- Large TEC current range: rated 18A (if the supply voltage is less than or equal to 12V, the current can reach 24A)
- Two-way control, support heating and cooling
- TEC configuration is flexible
- It can set and detect the temperature through the serial port (ASCII code protocol, supports the computer with its own super terminal, everyone can use it)
- It has alarm, ready signal output, and close TEC signal input
- Control mode: continuous voltage

Applications:

- Temperature control system with TEC (semiconductor cooler, thermoelectric cooler) as the temperature control element
- Suitable for but not limited to temperature control of laser diodes
- Suitable for various fields such as industry and home appliances
- Biological, medical, PCR temperature control, etc.

Main technical parameters:

- Board supply voltage: 7.5- 27V (standard voltages such as 7.5/12/15/24 are recommended, the TEC rated voltage is preferably equal to or slightly larger than the power supply voltage, if the TEC rated voltage is less than the power supply voltage, you can also set the maximum output ratio)
- Board supply current: determined by the actual maximum power of the TEC
- TEC voltage: 2V – 24V (depending on power supply voltage)
- TEC current: rated 18A (If power supply voltage is less than or equal to 12V, the current can reach 24A)
- Temperature control sensor: 10k NTC (default B value is 3950, the actual B value is not limited, only affects absolute temperature, not relative temperature, basically meaningless for temperature control), PT100 optional
- Temperature control accuracy: 0.01°
- Setting temperature accuracy: 0.01°
- NTC version temperature control measurement range: -60 - +170 degrees
- NTC version control temperature range: -20 - +100 degrees
- PT100/PT1000 temperature control measurement range: -60 - +212 degrees
- PT100/PT1000 control temperature range: -50 - +200 degrees
- Default factory setting temperature: 25°, or user specified
- Working ambient temperature: -40 to +45 degrees
- Storage ambient temperature: -40 to +60 degrees
- Working environment humidity: 0-95%

- Dimensions: 65mm*95mm, Height: 35mm

Ordering Information:

- Product name: temperature control board
- Product model: STXF-TCB-NE-AH/-X
- -X: Optional PT100 or PT1000 probe, omitting -X means that NTC probe is supported by default
- For example: TXF-TCB-NE-AH, TXF-TCB-NE-AH-PT100, TXF-TCB-NE-AH-PT1000

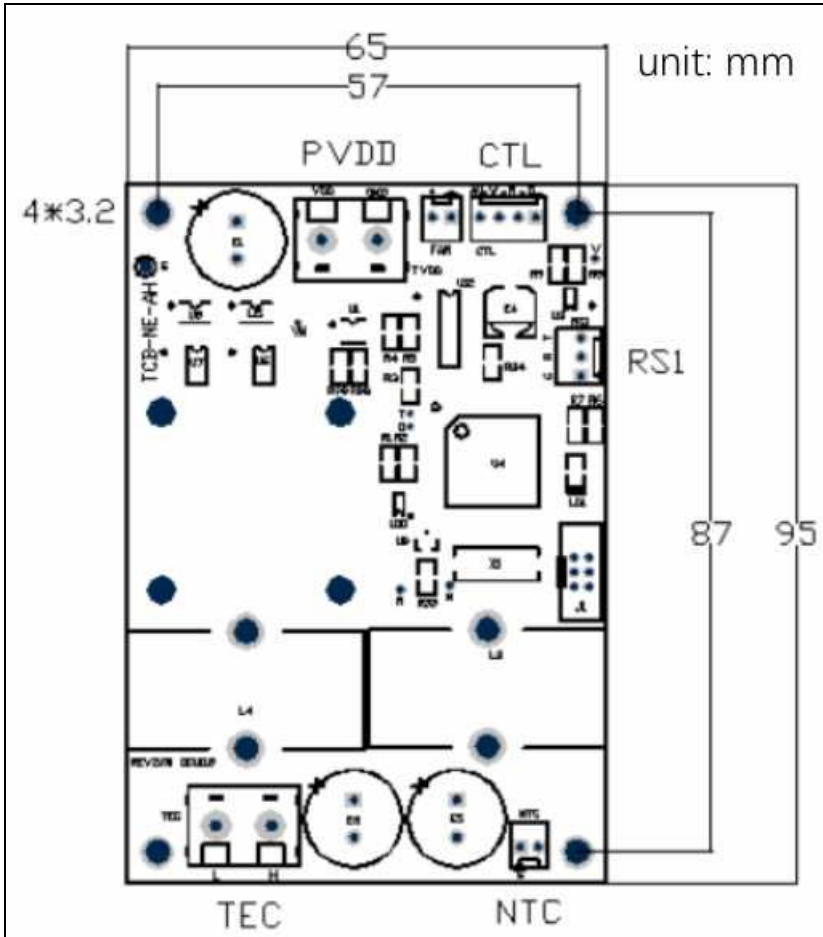
Dimensions:

Control Method:

The board uses serial communication to modify and monitor information. There are three control methods as follows:

- The temperature control display unit made by us such as STXF-DISP-TCB (connect the serial port of the temperature control board to the display screen)
- Our PC software STXF-TCBMate (connect the serial port of the temperature control board to the computer)
- Directly use the serial port to issue command control (using a microcontroller, or a PC)

3.2 Related products and accessories for temperature control panel:

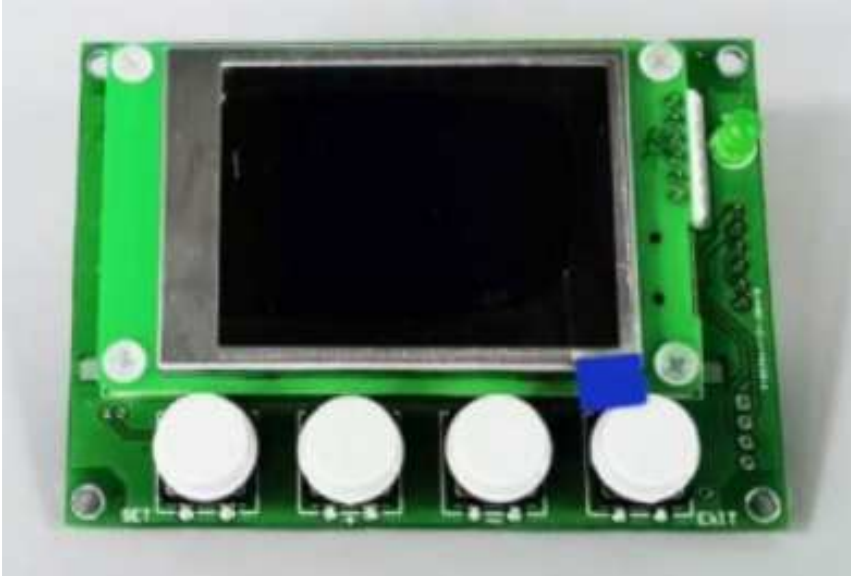
Name	Specifications	Supply voltage(V)	Features
Temperature control display panel	STXF-DISP-TCB	5,7-24	Support STXF-TCB series temperature control board
Temperature control display panel	STXF-DISP-TCB-P	5,7-24	Support STXF-TCB series temperature control board with metal panel
Temperature control display panel	STXF-CDM-TCB	5	Support STXF-TCB series temperature control board
Temperature control display panel	STXF-CDM-TCB-P	5	Support STXF-TCB series temperature control board with metal panel
TCB communication line	STXF-TCB-RS232		Support STXF-TCB series temperature control board
RS232 to RS485 Converter	STXF-UT-2201		
Serial hub board	RS232-NODE		RS232 HUB
USB to serial cable	UTR-01		

Details of STXF-DISP-TCB(DW) Temperature Control Display Board:

The STXF-DISP-TCB(DW) temperature control display board supports STXF-TCB-NA, STXF-TCB-NE/NE-AH, STXF-TCB-SA and other temperature control boards. The temperature value and various related parameters can be set through the temperature control display board, and the current temperature control information can be seen intuitively. The temperature control display board can be used as a setting tool for the temperature control board, or can be directly installed on the panel as the monitoring interface of the temperature control board.

Features:

- It can be easily installed on the customer's equipment panel
- Support STXF-TCB full range of temperature control boards
- Support the setting of various parameters
- Support temperature display as a curve
- It has a 7-28V power input port, and a 5V power input/output port and you can supply power through one of them

Ordering Information:

Product name: temperature control display board

Product model: STXF-DISP-TCB/-P(DW) -P: A -P suffix means a black panel. If there is no panel, it will be omitted directly.

For example: STXF-DISP-TCB(DW), STXF-DISP-TCB-P(DW)

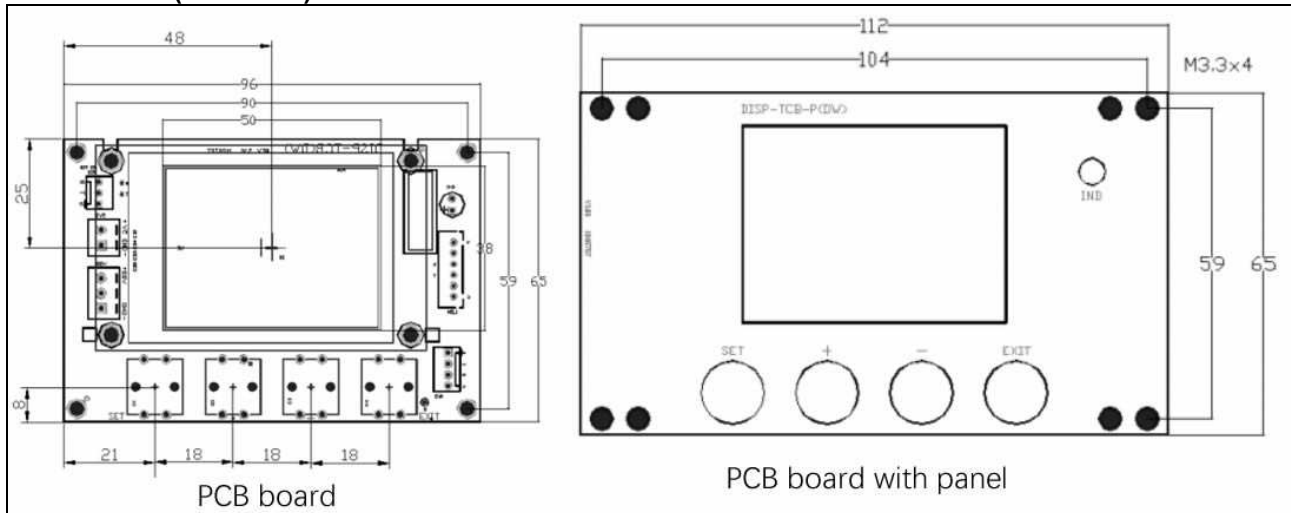
Dimensions (Unit: mm):

Electrical connection diagram:

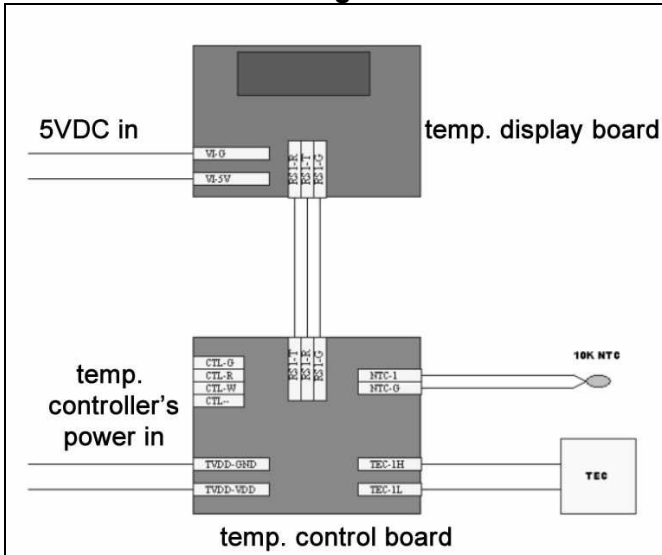

STFD Series Diode Drivers

1. STFD-SF3xx Series QCW Laser Diode Drivers

(1) QCW Laser Diode Drivers with RS232

Switched mode laser power supply is designed for supplying diode arrays, which are used for pumping powerful solid or fiber lasers. Power supply is designed to the laboratory, educational, experimental and industrial applications. Additionally the power supply can be equipped with a LD thermal stabilization controller (TEC controller). Also it has current limit, duty cycle limit and safety interlocks. Could be modified by a customer's request for the optimal selection of parameters for a specific load.



	STFD-SF306	STFD-SF315	STFD-SF350
Pulse rate* (F)	1-500Hz, single pulse	1-500Hz, single pulse	1-000Hz, single pulse
Output voltage* (V)	0-140 V	0-300 V	0-300 V
Output current* (I)	1-150 A	1-300 A	1-350 A
Pulse duration* (τ)	50-1000 μ s	50-1000 μ s	50-1000 μ s
Rise time**	<60 μ s	<60 μ s	<60 μ s
Fall time**	<60 μ s	<60 μ s	<60 μ s
Output current tolerance	0.3 %	0.3 %	0.3 %
Average output power* (P)	0.4 kW	1.5 kW	4.6 kW
Data display	LCD	LCD	LCD
Communication interface***	RS232	RS232	RS232
Trigger in	5 V, 10 μ s	5 V, 10 μ s	5 V, 10 μ s
Trigger out	5 V, 10 μ s	5 V, 10 μ s	5 V, 10 μ s
Trigger out delay	1-1100 μ s	1-1100 μ s	1-1100 μ s
Interlock	switch contact closure	switch contact closure	switch contact closure
Power Input	single phase 220 VAC, 50Hz	single phase 220 VAC, 50Hz	three phase 220/380 VAC, 50Hz
Type of cooling	air cooling	air cooling	air / water cooling
Dimensions	440*88*345 mm; 2U	440*132*440 mm; 3U	440*177*485 mm; 4U
Weight	10 kg	12 kg	25 kg

* Values are limited by average power: $F \cdot V \cdot I \cdot \tau \leq P$ (pulse mode); $V \cdot I \leq P$ (CW mode)

**With a length of laser diode power wire is not more than 2m

(2) STFD-SF303 OEM Switched Mode Power Supply with RS485

- Designed to power diode lasers, as well as any diode-pumped lasers.
- Optimized for laboratory, educational, experimental and industrial applications.
- Has current limit, duty cycle limit and safety interlocks.
- Can be modified according to customer requirements for optimal selection of parameters for a specific load.
- Optionally it can be equipped for work in a temperature -40 to +40 degree (STFD-SF303M).



	STFD-SF303 or STFD-SF303M
Pulse rate* (F)	1-10Hz, single pulse
Accuracy of the pulse rate	0.1Hz
Output voltage* (V)	0-25 V
Accuracy of the output voltage	0.1V
Output current* (I)	1-100 A
Accuracy of the output current	0.1A
Pulse duration* (τ)	50-5000 μs
Accuracy of the pulse duration	1μs
Rise time	<50 μs
Fall time	<25 μs
Output current tolerance	0.3 %
Average output power* (P)	150W
Communication interface***	RS485 (RS232 available upon request)
Trigger in	5 V, 10 μs
Trigger out	5 V, 10 μs
Output sync pulse dwell time	1-5100 μs
Power Input	single phase 220 VAC, 50Hz
Type of cooling	air cooling
Dimensions	130x60x220mm
Weight	<1 kg

* Values are limited by average power: $F \cdot V \cdot I \cdot \tau \leq P$ (pulse mode); $V \cdot I \leq P$ (CW mode)

** The difference between STFD-SF303 and STFD-SF303M is STFD-SF303 for normal use and SF303M for use at temperatures -40 to +40 degree. They both are OEM and have no display. Customer can control this from PC. For STFD-SF303(M) we can provide a control panel, but only for STFD-SF303(M) with RS485.

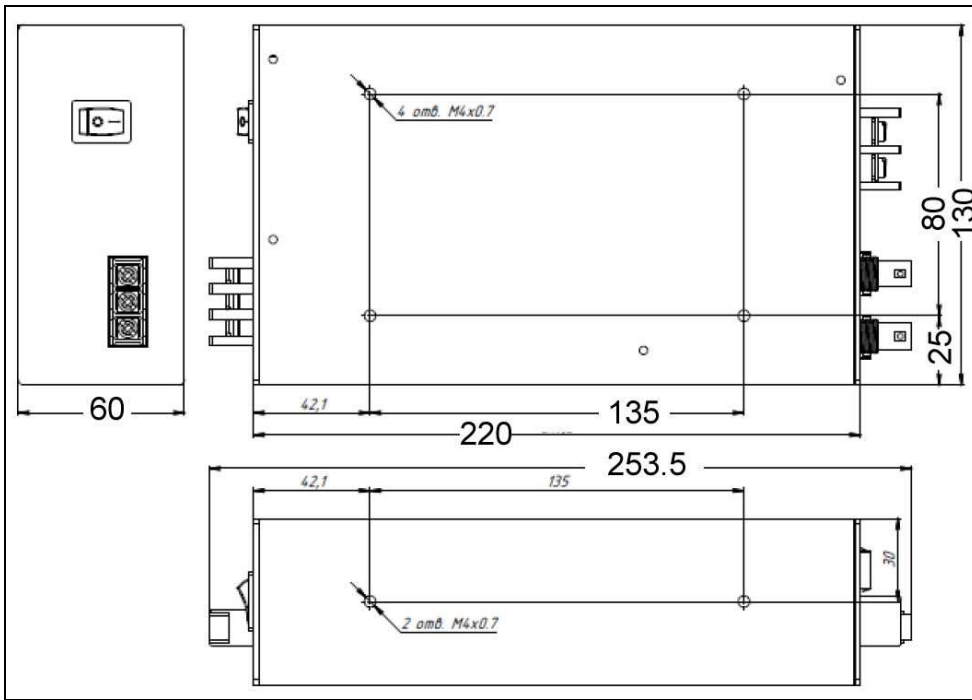

(3) STFD-SF305M Series OEM QCW Laser Diode Drivers

OEM switched mode laser power supply is designed for supplying diode arrays, which are used for pumping powerful solid or fiber lasers. Power supply is designed to the laboratory, educational, experimental and industrial applications. Additionally the power supply can be equipped with a LD thermal stabilization controller (TEC controller). Also it has current limit, duty cycle limit and safety interlocks. Could be modified by a customer's request for the optimal selection of parameters for a specific load.



	STFD-SF305M
Pulse rate (F)	1-100 Hz, single pulse
Accuracy of the pulse rate	0.1 Hz
Output voltage (V)	0-360 V
Accuracy of the output voltage	0.1 V
Output current (I)	1-60 A
Pulse duration (τ)	50-250 μ s
Accuracy of the output current	0.1 A
Accuracy of the pulse duration	1 μ s
Rise time	<50 μ s
Fall time	<25 μ s

Output current tolerance	0.3%
Average output power* (P)	500 W
Communication interface	RS485
Trigger in	5 V, 10 μ s
Trigger out	5 V, 10 μ s
Trigger out delay (Output sync pulse dwell time)	1-350 μ s
Power Input	single phase 220 VAC, 50Hz
Type of cooling	air cooling
Dimensions	250x175x70mm; 1U
Weight	<1 kg

2. STFD-SF4xx Series OEM CW Laser Diode Drivers

CW laser power supply for diode-pumped lasers is designed to supply diode arrays, which are used for the pumping of high-power solid-state or fiber lasers. Power supply is designed for operation in the laboratory, educational, experimental and industrial applications. Also it has current limit, duty cycle limit and safety interlocks. Could be modified by a customer's request for the optimal selection of parameters for a specific load.

	STFD-SF4xx
Output voltage* (V)	25 V
Voltage changing	1 V
Output current* (I)	40 A
Current changing	1 A
Output current tolerance	0,3 %
Average output power* (P)	500 W
Data display	Software for the PC
Communication interface	RS485
Trigger in	5 V, 10 μ s
Trigger out	5 V, 10 μ s
Interlock	switch contact closure
Cooling	air cooled
Power Input	single phase 220 VAC, 50Hz
Dimensions	250*170*70 mm; 1U
Weight	2 kg

3. STFD-SF5xx Series CW/QCW Laser Diode Drivers

Pulse / CW laser power supply for diode-pumped lasers is designed to supply diode arrays, which are used for the pumping of high-power solid-state or fiber lasers. Power supply is designed for operation in the laboratory, educational, experimental and industrial applications. Additionally the power supply can be equipped with a thermal stabilization controller (TEC controller). Also it has current limit, duty cycle limit and safety interlocks. Could be modified by a customer's request for the optimal selection of parameters for a specific load.



	STFD-SF530		STFD-SF550	
	pulsed mode	CW	pulsed mode	CW
Pulse rate* (F)	1-500Hz, single mode	-	1-1000Hz, single mode	-
Output voltage* (V)	0-160 V	0-160 V	0-200 V	0-200 V
Output current* (I)	1-300 A	1-150 A	1-300 A	1-150 A
Pulse duration* (τ)	50-1000 μ s	-	50-1000 μ s	-
Rise time**	<60 μ s	-	<60 μ s	-
Fall time**	<60 μ s	-	<60 μ s	-
Output current tolerance	0.3 %	0.3 %	0.3 %	0.3 %
Average output power* (P)	2.5 kW	2.5 kW	4.6 kW	4.6 kW
Data display	LCD		LCD	
Communication interface	RS232		RS232	
Trigger in	5 V, 10 μ s		5 V, 10 μ s	
Trigger out	5 V, 10 μ s		5 V, 10 μ s	
Interlock	switch contact closure		switch contact closure	
Cooling	air / water cooled		air / water cooled	
Power Input	single phase 220 VAC, 50Hz		three phase 220/380 VAC, 50Hz	
Dimensions	440*132*440 mm; 3U		440*132*485 mm; 4U	
Weight	23 kg		25 kg	

* Values are limited by average power: $F \cdot V \cdot I \cdot \tau \leq P$ (pulse mode); $V \cdot I \leq P$ (CW mode)

**With a length of laser diode power wire is not more than 2m

5. STFD-MEPSS Multichannel Electric Power Supplied System for Diode-pumped Lasers

Laser multichannel electric power supplied system is designed for supplying high-power multi-channel lasers. The power supply system of a powerful multi-channel laser is used in special laser systems, laser technological complexes, in researches of laser-matter interaction; inertial confinement fusion; stands for the laser diodes arrays testing and etc. STFD-MEPSS can be equipped with all any supplies and charging modules. The company has experience in designing STFD-MEPSS with the number of power supplies up to 50 pieces. The potential number of units is unlimited. The STFD-MEPSS structure includes modules that provide control and synchronization of power supplies.



	STFD-MEPSS
Average output power	250 kW
Numbers of modules	2-50
Numbers of triggers	1-8
External communication interface	RS232, USB, Ethernet
Internal communication interface	RS232, FOLC
Mode	synchronous / asynchronous
Trigger type	Internal / External
Input power	310 kW max
Cooling	Air/water cooled
Power Input	three-phase 220/380 VAC, 50 Hz

STOP Series Pulse Diode Drivers, Optical Pulse Generators & Seeders

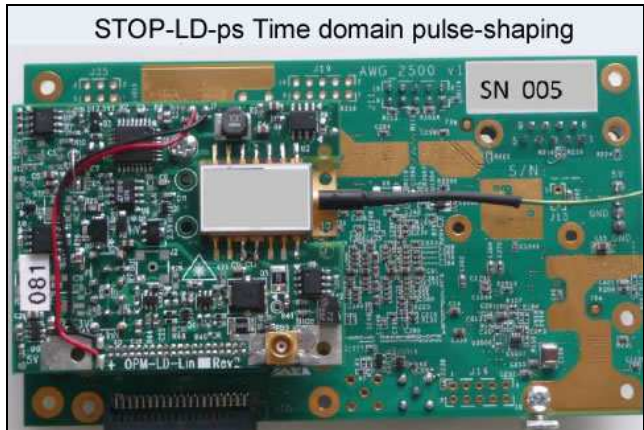

We have unique capabilities in optical pulse generators, seeders and drivers.

Our STOP-LDa series includes pulser products with pulse-width range from pico-seconds to micro-seconds and with peak power of over 1W.

Our ANYPULSE technology (patent pending) offers programmable time-domain waveform generation with optical transmission. Our control software allows the user to program his own waveform in nano-second resolution and 11 bit amplitude resolution.

Our high-speed and high power linear laser drivers convert analog signals to optical transmission with peak laser current up to 3A. Our high-speed and high power digital laser drivers convert digital signals to optical transmission with peak laser current up to 0.5A, data rate up to 1Gb/s and handling of PRBS data patterns.

We integrate in our products the laser diode or LED that you need: cooled or uncooled, wavelength range from UV to IR, including 1064 and 1550nm. An evaluation board and accessories are offered for quick evaluation of our modules.

Product Applications

- Seeders for pulsed fiber-lasers
- Laser source for 3D cameras (Time-of-Flight)
- Pulsers for Laser-Range-Finders and LIDARS
- Transmitters for telecomm applications
- Time Domain Fluorescence Microscopy



----- Optical waveforms examples -----

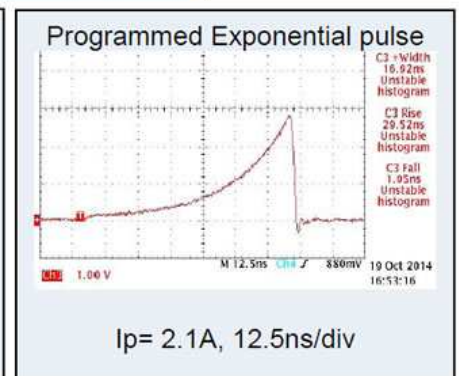
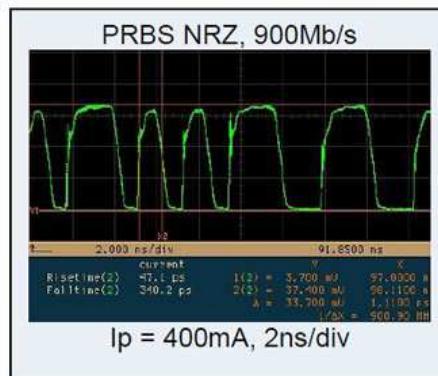
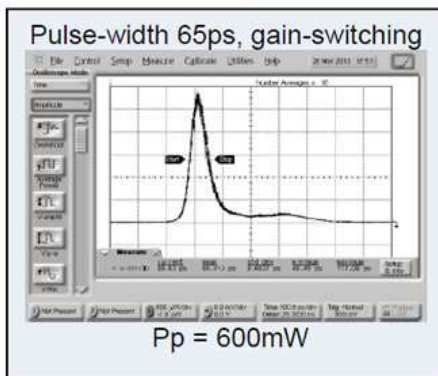

Product List

1. STOP-LDa pulser series:

The STOP-LDa pulsers include a laser pulser, TEC controller and laser diode. Peak power up to over 1W. Duty cycle limit ~ 10%. High speed or high current versions.

- STOP-LDa-gs: fixed pulse-width of 50ps to 150ps – gain switching.
- STOP-LDa-3: pulse-width of 0.5 to 3ns with continuous pulse-width tuning.
- STOP-LDa-64: pulse-width of 1 to 64ns in 0.25ns steps and fine tuning.
- STOP-LDa-128: pulse-width of 1 to 128ns in 0.5ns steps and fine tuning.
- STOP-LDa-256: pulse-width of 1 to 256ns in 1ns steps and fine tuning.
- STOP-LDa-1250: pulse-width of 10 to 1250ns in 5ns steps and fine tuning.
- STOP-LD-H1: Peak pulse current: up to 25A / 50A, pulse-width options in range of 10ns to 1us in 5ns steps, frequency up to 10MHz.

2. Pulse Shaping (time domain) products:

- STOP-AWG2500: Arbitrary Waveform Generator with time resolution of 555ps. Other resolution - per request.
- STOP-LD-Lin-HC: Linear optical transmitter, peak current up to 2A (~3A nonlinear), rise/fall time ~1.5ns.
- STOP-LD-Lin-HS: Linear optical transmitter, peak current up to 0.5A, rise/fall time ~0.6ns.
- STOP-LD-ps: This product is a combination of the AWG2500 and the STOP-LD-Lin. It acts as an optical arbitrary waveform generator. Programmable in time resolution of 555ps.
- STOP-SW-ps1: PC software with a friendly GUI for the STOP-LD-ps and for the STOP-AWG2500. Allows programming of any waveform and comprehensive control.
- STOP-AMP-700: Pulse amplifier to drive MZ modulators. Complements the STOP-AWG2500 in applications where a MZ modulator is required. Peak voltage up to 5V. Tr/Tf ~ 1ns.

3. Laser driver for 3D ToF cameras

- STOP-LD-D1: Digital transmitter, peak current up to 500mA, data rate up to 1Gb/s. Tr/Tf ~ 350ps. CML or ECL data input. Supports PRBS patterns. The product also suits special telecom applications.

4. Evaluation board (Test Jig) and accessories:

- Test jig for standard products: Suits all STOP-LD products. Provides power control and trigger.
- STOP-EXT40-2: 40 wire, 50cm long cable for connecting to all STOP-LD products in OEM applications.
- SMA to MCX (male) RF cable: For monitoring the laser current in all STOP-LD products.
- SMA to MCX (female) RF cable: For direct connection to AWG2500 RF outputs.

Product options:

- High speed versions or high current versions.
- Built in potentiometers or external controls.
- Laser diodes types: BTF or coax packages, various wavelength.
- OEM modules or benchtop instruments.

Details of Products

1. STOP-LDa Pulsers Series

- All seeder's functions integrated in one assembly: Adjustable pulse generator; Pulse driver; Efficient TEC controller; Laser diode
- Pulse-width coverage of picoseconds (gain-switching) to micro-seconds
- Peak current up to 3A
- Pulse width, bias, temperature and amplitude (optional) adjustments
- External or on-board controls
- Wide selection of laser diodes or LEDs
- Monitoring for all key parameters

1.1 STOP-LDa-gs Seed Laser / Picoseconds optical Pulser / Driver

- Fixed pulse width of 50ps to 150ps

The STOP-LDa-gs seed laser assembly is an integrated solution for the seed (oscillator) part of pulsed MOPA fiber laser systems. The assembly includes all the key functions needed in a high-performance seeder, including a trigger generator, an adjustable pulse-width generator, laser driver, TEC controller and an integrated laser diode.

The optical peak power can be adjusted by an on-board potentiometer. The trigger source is selectable: internal or external. In external trigger mode each incoming trigger signal (rising edge) results in a generation of a single pulse.

The optical pulse-width is controlled by an external analog control voltage. The pulse-width range is from gain-switching mode (~50ps) to over 1ns. The module has also analog control inputs for bias current and set temperature. Each of the input analog control signals can be replaced by an on-board potentiometer so that the module can either be controlled externally or have internal settings. With the bias current-control the user can impact the optical spectral width or to change the extinction ratio.

The product is designed to operate in a wide temperature range and in maintenance-free conditions – making it a good choice for OEM integration in industrial laser systems. Various product options are being offered.

Features

- All seeder's functions integrated in one assembly: Adjustable pulse generator from gain-switched operation (~50ps) to 1ns; On-board trigger generator: 4K-20MHz; Efficient TEC controller; Laser diode; Designed for OEM in laser systems
- Compact: 62mm x 45mm
- Typical optical peak power of 0.5W
- Pulse amplitude control
- Tunable bias-current up to 50mA (or 200mA)
- On board potentiometers or external controls
- Efficient protection on the laser diode
- Wide selection of laser diodes in wavelengths of 1064nm, 1550nm and more
- Monitoring of all key parameters
- Quick evaluation by STO's test jig or CSW-3 controller board or a cable assembly EXT-40-2

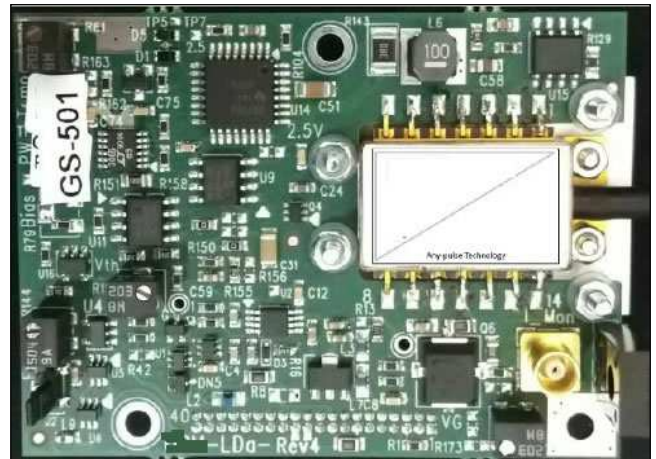

Product Applications

- Seed Laser for fiber lasers
- Optical pulser for high-resolution LIDAR
- Characterization of high-speed optical receivers

Optical Waveform / Gain-Switching 61ps

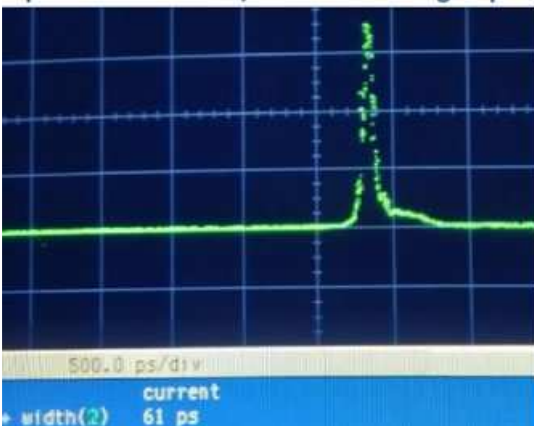

Optical Waveform 1ns

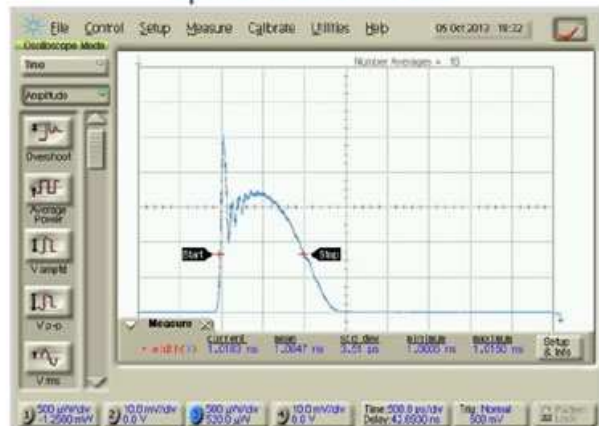

Parameter	Value	Comments
-----------	-------	----------

Pulse width range in gain-switched mode	40ps to 150ps	Depends on laser diode type
Peak power	200mW to ~1W	Depends on laser diode type
Bias current	0 to 50mA	Can be increased to 100mA upon request
Pulse frequency range	Single shot to 20MHz	Can be optimized to 20MHz ~ 80MHz
Trigger input	TTL/LVTTL	Rising edge, high impedance
Enable module controls	TTL/LVTTL	Laser enable, TEC enable
TEC driver current	In range of -2A to +2A	
Laser temperature accuracy	Better than 0.1C	After stabilization
Operating temperature range	0 to 60C	Other range - upon request
Supply voltages	5V / 12V or 5V / 24V	
Dimensions	62mm x 45mm	
Installation options	Vertical or horizontal	
Main connector	Samtec TFM-120 series	40 pin

Suitable Laser Diodes

Various laser diodes are available to be used with the STOP-LDa-gs: DFB, FP or FBG types; wavelengths of 1030nm, 1064nm, 1310nm, 1480nm, 1550nm or other custom wavelengths. Butterfly package (14 pins or 10 pins) or Coaxial package.

Ordering Information

	Power Supply	Mounting	TEC Controller	Trigger Generator	Potentiometers	Bias* current of 0-200mA	Laser Diode
STOP-LDa-gs	5/12V (12) or 5/24V (24)	Horizontal (H) / Vertical (V)	Yes (T) / No (X)	Yes (G) / No (X)	Yes (P) / No (X)	Yes (B) / No (X)	Laser diode description
Example of a product code for an STOP-LDa-gs module that operates on power supply of 12V, horizontal mounting, with TEC controller, trigger generator, no potentiometers, 200mA bias and a 1064 DFB laser diode: STOP-LDa-gs-12-H-T-G-X-B-1064DFB							
STOP-LDa-gs	12 V (12)	Horizontal (H)	Yes (T)	Yes (G)	No (X)	Yes (B)	1064 DFB laser diode

* For bias current of 200mA a heat sink is required and the module length grows to 80mm.

For a comprehensive description of module's pin-out and controls please contact us.

1.2 STOP-LDa-3 Seed Laser / Optical Pulser Assembly

- Pulse width of 0.5ns to 3ns with continues pulsewidth tuning

The STOP-LDa-3 seed laser assembly is an integrated solution for the seed (oscillator) part of pulsed MOPA fiber lasers systems. The assembly includes all the key functions needed in a high performance seeder, including an adjustable pulse-width generator, laser driver, TEC controller and an integrated laser diode.

Each incoming trigger signal (rising edge) results in a generation of a single pulse. The pulse-width is adjustable in the range from 0.5ns to over 3ns. An on-board trigger generator is an optional feature. The module has analog control inputs: Pulse-width, bias current and set temperature (also optional amplitude control). Each of the input analog control signals can be replaced by an on-board potentiometer so that the module can either be controlled externally or have internal settings. With the bias current control the user can impact the optical spectral width or to change the extinction ratio.

The product is designed to operate in a wide temperature range and in maintenance-free conditions – making it a good choice for integration in commercial and industrial laser systems.

Features

- All seeder's functions integrated in one assembly: Adjustable pulse generator from 0.5ns to 3ns; Pulse driver; Efficient TEC controller; Laser diode.
- Designed for OEM in laser systems
- Compact: 62mm x 45mm
- Peak laser current of 2A / Optical peak power up to 1W
- Bias current control to control optical spectrum
- Efficient protection on the laser diode

- On board potentiometers or external controls
- Wide selection of laser diodes in wavelength of 1064nm, 1550nm and more
- Monitoring of all key parameters
- An evaluation board is available for quick evaluation
- Cable assembly is available for connecting to customer's system

Product Applications

- Seed laser for Fiber lasers
- Optical pulser for LRF or LIDAR target simulators
- Time domain fluorescence microscopy
- 3D Vision systems
- Characterization of high speed optical receivers

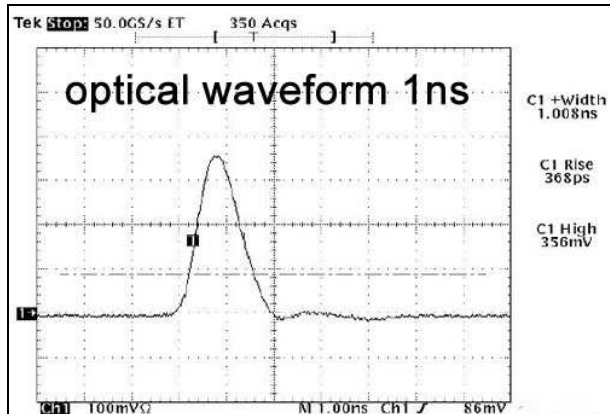
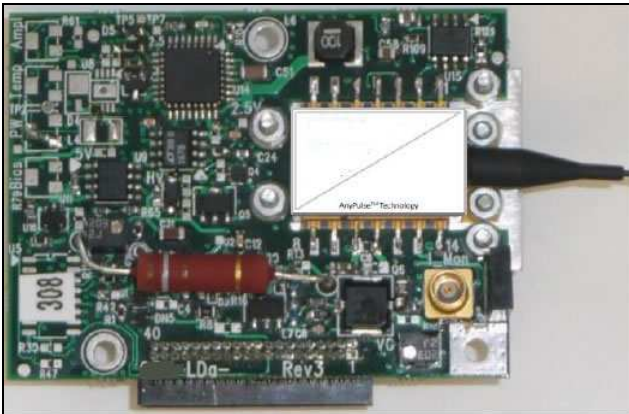

Parameter	Value	Comments
Pulse width range	0.5ns to 3ns	
Peak laser current	2A (@PW=3ns)	24V version; Can be increased upon request
Bias current	0 to 50mA	Can be increased to 100mA upon request
Peak optical power	Typical 600mW, up to 1W	Depends on laser diode
Pulse frequency range	Single shot to 20MHz	Can be optimized to 20MHz to 80MHz operation
Trigger input	TTL/LVTTL	Rising edge, high impedance
TEC driver current	In range of -2.5A to +2.5A	
Laser temperature accuracy	Better than 0.1C	After stabilization
Operating temperature range	0 to 60C	Other range - upon request
Supply voltages	5V / 12V or 5V / 24V	Single 5V power option
Size	62mm x 45mm	
Installation options	Vertical or horizontal	
Main connector	Samtec TFM-120 series	40 pin

Suitable Laser Diodes

Various laser diodes are available to be used with the STOP-LDa-3: DFB, FP or FBG types; wavelengths of 1030nm, 1064nm, 1310nm, 1480nm, 1550nm or other custom wavelengths. Butterfly package (industrial type) or Coaxial package

	Power Supply	Mounting	TEC Controller	Trigger Generator	Potentiometers	Laser Diode
STOP-LDa-3	5/5V (5) or 5/12V (12) or 5/24V (24)	Horizontal (H) / Vertical (V)	Yes (T) / No (X)	Yes (G) / No (X)	Yes (P) / No (X)	Laser diode description
Example of a product code for an STOP-LDa-3 module that operates on power supply of 24V, vertical mounting, with TEC controller, no trigger generator, no potentiometers and a 1064 DFB laser diode: STOP-LDa-3-24-V-T-X-X-1064DFB						
STOP-LDa-3	24 V (24)	Vertical (V)	Yes (T)	No (X)	No (X)	1064 DFB laser diode

1.3 STOP-LDa-64-Ins-DFB Seed Laser / Optical Pulser Instrument

The STOP-LDa-64-Ins-DFB is a flexible seeder instrument that can be used in pulsed MOPA fiber lasers systems. The instrument includes all the key functions needed in a high performance seeder, including an adjustable trigger generator, a pulse-width generator, laser driver, TEC controller and an integrated laser diode.

The instrument can be triggered by incoming trigger signal (rising edge) too. The pulse-width is adjustable in 8 bit resolution and an addition of fine tuning. Bias current of the laser can be tuned by the user to impact the optical spectral width.

The laser diode's temperature can be controlled by the user for fine wavelength control. The back side of the instrument includes interlock connector for safety and a USB connector for control by user's PC (A windows operating system is required).

Features

- A powerful and flexible nano-second seeder in a benchtop enclosure: Adjustable pulse-width generator and trigger generator; Pulse driver; TEC controller for fine wavelength tuning; Laser diode
- Adjustable pulse-width 1ns to 64ns (Note 1)
- Adjustable repetition rate from 2.5KHz to 25MHz and external trigger up to 40MHz
- Includes a 1064nm DFB laser diode (Note 2)
- Peak laser current of 2A / Optical peak power up to 800mW (Note 3)
- Bias current control for superior spectral control
- Graphical User Interface to control all instrument's functions
- Optical output provided through an FC/APC connector
- RF output to monitor laser's current

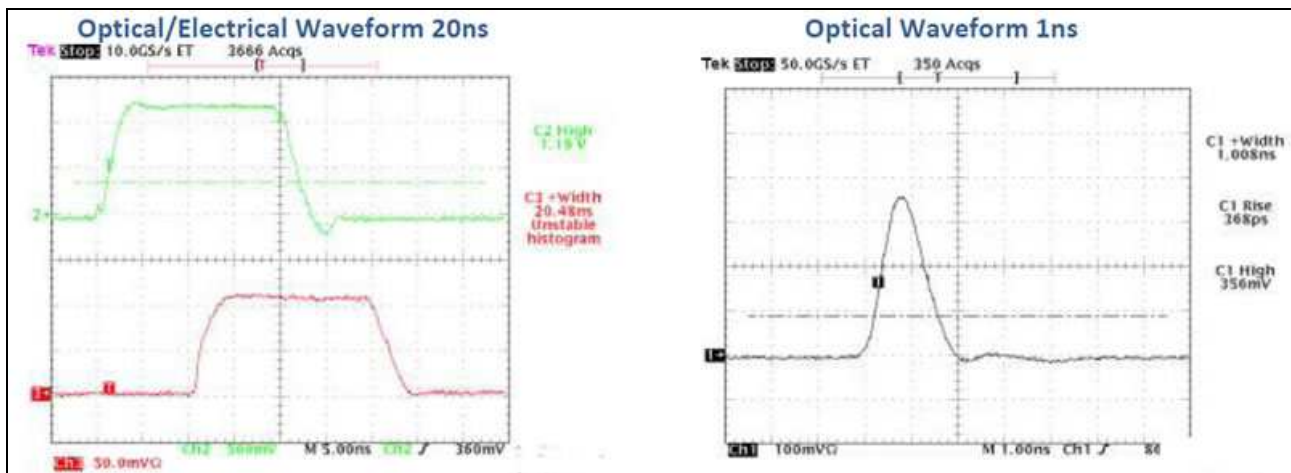

Product Applications

- Seed laser for fiber lasers
- Optical pulser for LRF or LIDAR target simulators
- 3D Vision systems

Parameter	Value	Comments
Pulse width range	STOP-LDa-64: 1ns to 64ns	
Fine pulse-width tuning	At least +/-1ns	continues
Peak laser current	2A	Might change according to laser diode's selection
Bias current	0 to 50mA	Can be increased to 100mA upon request

Peak optical power	Typical 750mW	At pulse-width of 4ns to 64ns
Pulse frequency range	Single shot to 40MHz	Subjected to duty-cycle limit of 10%
Trigger input from external generator	TTL/LVTTL Frequency from single shot to 40MHz	Rising edge. Trigger pulse-width must be larger than the programmed pulse-width.
Enable driver	By key, interlock and GUI command	
Laser temperature control	In range of +/-25C	At ambient temperature of 10 to 40C
Laser temperature accuracy	Better than 0.1C after stabilization	
Operating temperature range	10 to 40C	Other range -upon request
Supply voltages	24V	A 24V wall adaptor is supplied with the instrument
Power consumption	6W typical, 15W maximum	
Dimensions	225 x 84 x 200 (W x H x D)	millimeters

Ordering Information

For the instrument with a 1064nm DFB laser diode the order number is -STOP-LDa-64-Ins-DFB-1064

- Notes: (1) Other pulse-width ranges are available too. Please contact us for details.
 (2) Other laser diodes in various wavelengths are available too. Please contact us for details.
 (3) Peak power up to 1.5W – using selected laser diodes.

1.4 STOP-LDa-YYY-HS Seed Laser / Optical Pulser Assembly

The STOP-LDa-yyy-HS series seed modules are integrated solutions for the seed (oscillator) part of pulsed MOPA fiber lasers systems. The modules include all the key functions needed in a high-performance seeder, including an adjustable pulse-width generator, laser driver, TEC controller and an integrated laser diode. Each incoming trigger signal (rising edge) results in a generation of a single pulse. The pulse-width is adjustable in 8 bit resolution and an addition of fine tuning. The four products in this series cover total pulse width range from 1ns to 256ns. The module also has analog control inputs: Fine pulse-width, bias current and set temperature. Each of the input analog control signals can be replaced by an on-board potentiometer so that the module can either be controlled externally or have internal settings.

The product is designed to operate in a wide temperature range and in maintenance-free conditions – making it a good choice for integration in commercial and industrial laser systems.

Features

- All seeder's functions integrated in one assembly: Adjustable pulse generator 1ns to 256ns in 3 product versions; Pulse driver; Efficient TEC controller; Laser diode.
- Designed for OEM in laser systems
- Compact: 63mm x 50mm
- HS version: Optical rise and fall times below 1ns (Tested at 20%-80% levels)
- Peak laser current of 800mA
- Bias current control
- Efficient protection on the laser diode
- On board (pots) or external controls
- Wide selection of laser diodes
- Monitoring of all key parameters
- A controller board with GUI software is available to enable PC control.



Product Applications

- Seed Laser for Fiber Lasers
- Optical pulser for LRF or LIDAR target simulators
- 3D Vision systems

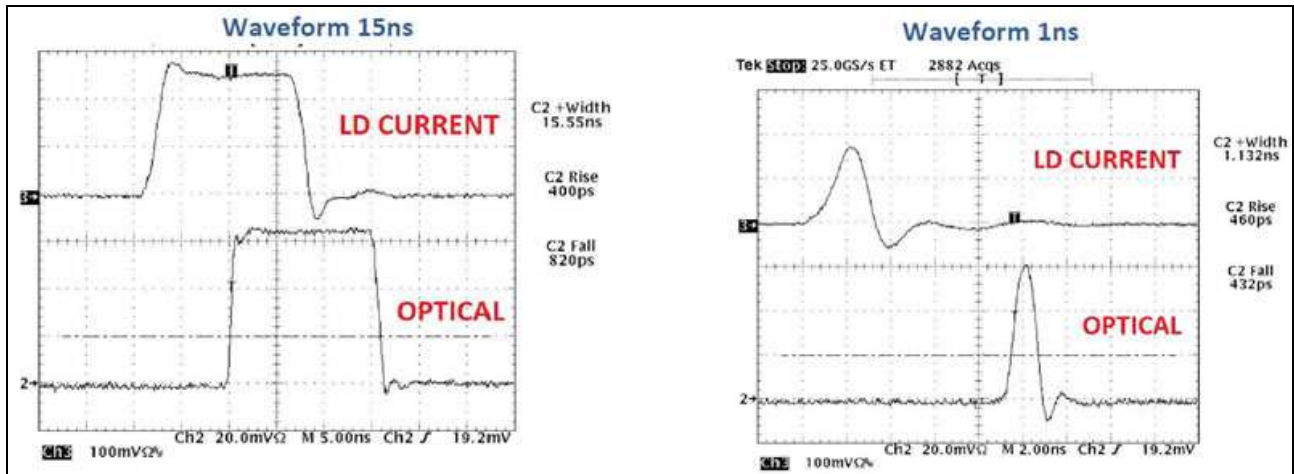

Parameter	Value	Comments
Pulse width range	STOP-LDa-64: 1ns to 64ns STOP-LDa-128: 1ns to 128ns STOP-LDa-256: 1ns to 256ns	Resolution of 0.25ns Resolution of 0.5ns Resolution of 1ns
Fine pulse-width tuning	At least +/- 1ns	
Peak laser current	At least 800mA At least 600mA	Using 16V power supply Using 12V power supply
Bias current	0 to 50mA	Can be increased to 100mA upon request
Peak optical power	Typical 400mW	Depends on laser diode
Pulse frequency range	Single shot to 10MHz	Subjected to duty-cycle and thermal limitations
Trigger input	TTL/LVTTL	Rising edge, high impedance. Trigger pulse-width must be larger than the programmed pulse-width
Enable driver	TTL/LVTTL	Laser enable, TEC enable
TEC driver current	In range of -2.5A to +2.5A	
Laser temperature accuracy	Better than 0.1C after stabilization	
Operating temperature range	0 to 60C	Other range - upon request
Supply voltages	5V / 12V or 5V / 16V	Single 5V power option
Dimensions	63mm x 50mm	
Installation options	Vertical or horizontal	
Laser diode heat-sink	Flat type or bracket	

Suitable Laser Diodes

Various laser diodes are available to be used with the STOP-LDa-yyy: DFB, FP or FBG types; wavelengths of 1030nm, 1064nm, 1310nm, 1480nm, 1550nm or other custom wavelengths. Butterfly package (industrial type) or Coaxial package

	Max Pulse Width (ns)	Power Supply	Mounting	TEC Controller	Potentiometer	Laser Diode
STOP-LDa-yyy-HS	64/128/256	5/5V (5), 5/12V (12) or 5/16V (16)	Horizontal (H) / Vertical (V)	Yes (T) / No (X)	Yes (P) / No (X)	Laser diode description

Example of a product code for an STOP-LDa-128 module that operates on power supply of 12V, horizontal mounting, with TEC controller, no potentiometers and a 1064 FBG laser diode: STOP-LDa-128-HS-12-H-T-X-1064FBG

STOP-LDa	128-HS	12 V	Horizontal	Yes	No	1064 FBG laser diode
----------	--------	------	------------	-----	----	----------------------

2. Transmitter modules for LIDAR: STOP-LDb-5/10

The STOP-LDb series modules were designed for systems requiring a short optical pulse source with high peak power. The modules operate in frequencies of DC up to 5MHz. The peak current is up to 25A and the optical peak power (at 905nm) is up to 75W – depending on the selected laser diode. In order to protect the laser diode, the average optical power is limited to 0.1W. The modules operate on a single 12V power supply and a trigger input signal in LVTTTL or TTL levels (rising edge).

Optical pulse-width is programmable in two ranges:

- Part number STOP-LDb-5: Range of sub-nanosecond to 5ns.
- Part number STOP-LDb-10: Range of 3ns to 10ns.

The peak power is programable too.

Pulse-width and peak power programming is done either by on-board potentiometers or by external analog voltage controls. A monitor signal indicates the average laser current. The module was designed to be integrated in real-life systems that operate for years.

Features

- Optical transmitter for LIDAR applications
- A compact and robust OEM module for variety of applications, including automotive
- Peak current up to 25A and peak power up to 75W
- Programmable pulse-width setting from 1ns to 10ns
- Operating frequency from DC to over 5MHz*
- Operates on a single 12V power supply
- A built-in step up power supply
- LVTTTL / TTL trigger input
- Selection of laser diodes in TO can, SMD package or LD chip.
- Selection of wavelengths: 905nm, 1550nm or custom.
- Enhanced thermal design to maximize performance
- Four mounting holes to fit the module in your system and attach optics

(*) With reduced peak power

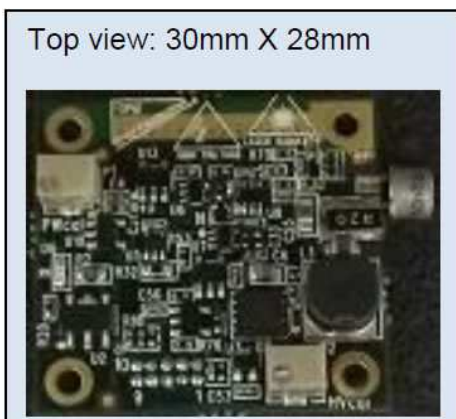

Pin-out

I_mon	1
12V_Power	2
GND_LD	3
GND	4
	5
HV_ctr	6
PW_fine	7
Enable	8
	9
Trig_in	10

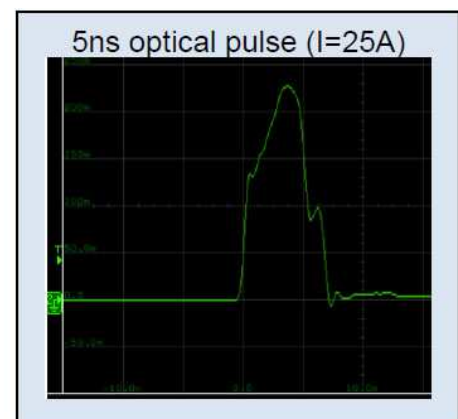

Product applications

- LIDAR for Automotive
- 3D terrain mapping
- Augmented reality
- Gesture recognition
- High resolution LRF

3. STOP-LD-ps Seed Laser Assembly with pulse shaping

The STOP-LD-ps series seed laser assembly is an integrated solution for the seed (oscillator) part of pulsed MOPA fiber lasers systems. The assembly includes all the key functions needed in a high

performance seeder, including an arbitrary waveform generator, laser driver, TEC controller and an integrated laser diode.

The product is designed to operate in a wide temperature range and in maintenance-free conditions – making it a good choice for integration in laser systems for industrial, bio/medical and military applications.

Features

- Multiple functions integrated in one unit: Arbitrary waveform generator; High bandwidth linear current driver; Efficient TEC controller; Laser diode
- Our Anypulse™ technology
- Flexible pulse shaping with 1ns resolution
- Laser current up to 2A with 11 bit resolution
- Triggering modes: Internal, external, loops
- Serial interface to PC or to customer's system
- PC control and intuitive GUI control
- Available wavelength: 1550nm, 1064nm or custom
- OEM circuit board (12cm x 7cm) or lab instrument

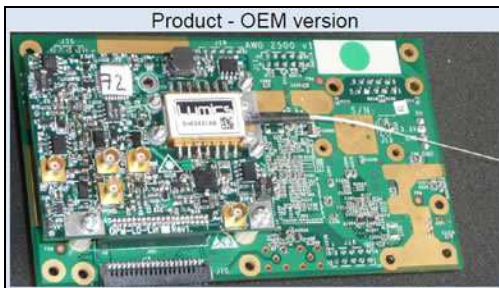

Benefits of pulse shaping

- Comprehensive waveform control to enhance performance of pulsed fiber laser systems
- Increases energy conversion efficiency in wavelength converters.
- Adds flexibility to laser systems to perform a wide range of material processing tasks.

Product applications

- Seed laser for Fiber Lasers
- Simulator for laser-range-finders and LIDAR systems
- Waveform or pulse generator for high speed electronic systems

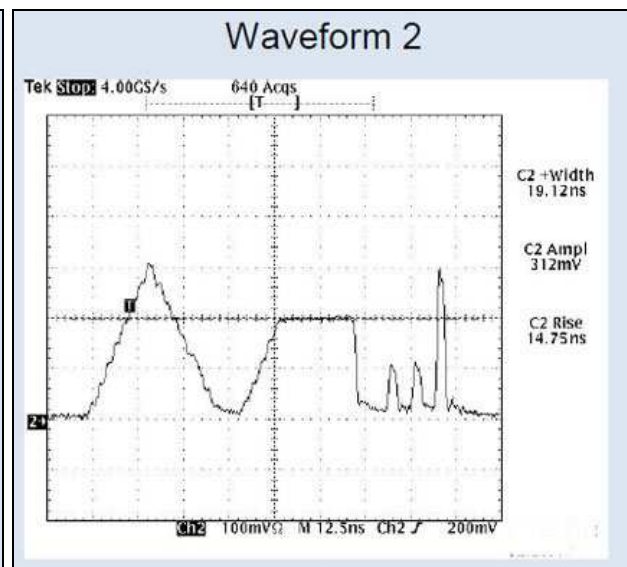
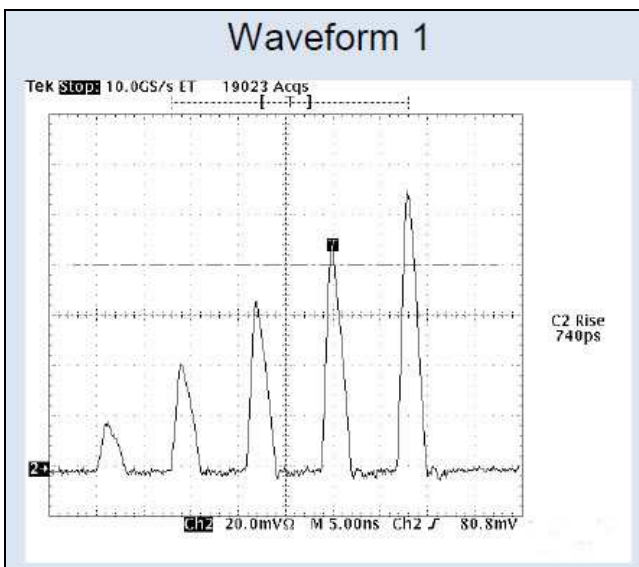

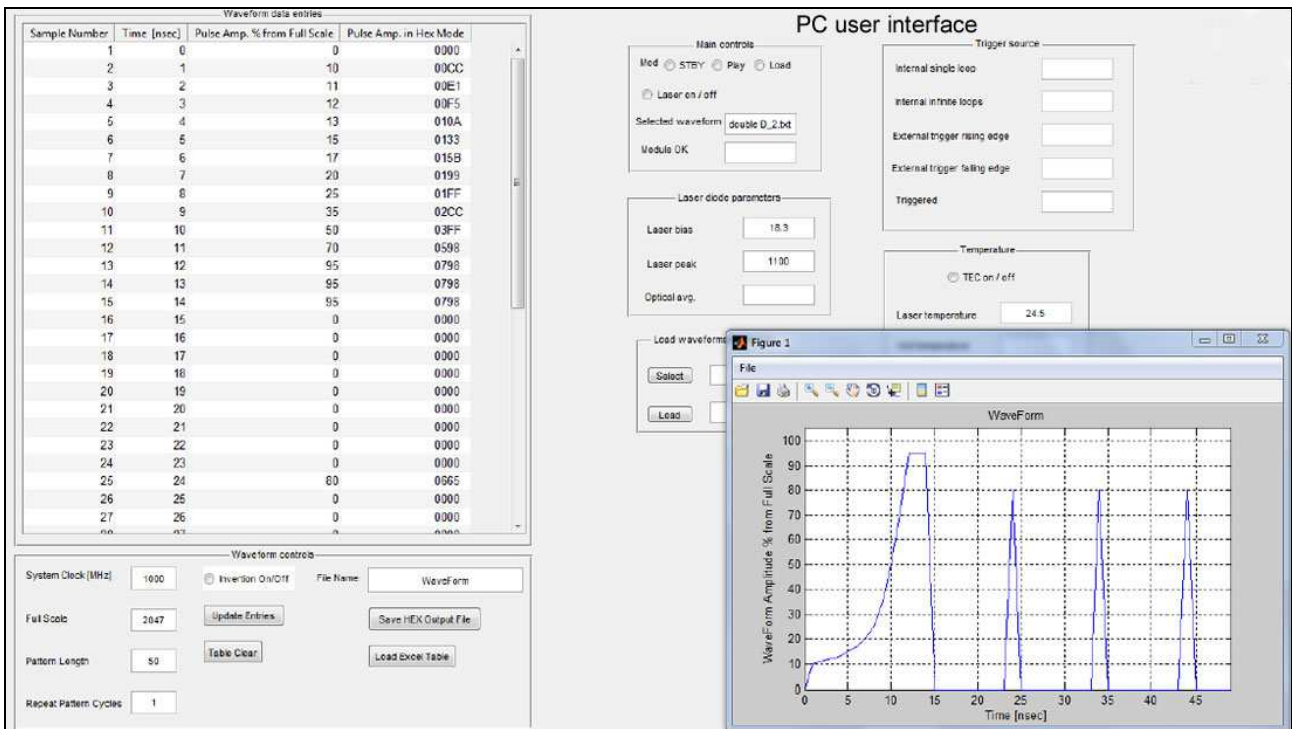

4. Controller and GUI for STOP-LD series modules

Our Controller/GUI is compatible to all STOP-LD series modules. The product shall be used in conjunction with any of the STOP-LD modules. The product's main features are:

- RS-232 connectivity and USB connectivity using a RS232-USB cable.
- A single Power supply (12V or 24V). The controller provides the supply voltages to the STOP-LD module.
- On board trigger generator 2.5KHz to 25MHz and supporting external trigger from DC to up to 50MHz.

The STOP-LD module with the Controller/GUI form a capable and easy to use solution with no need to deal with manual calibrations and analog control signals.



Features

- The Controller/GUI matches all our STOP-LD modules (pulsers and laser drivers)
- RS-232 interface (USB using a serial-USB cable)
- Eliminates the need for discrete control inputs
- GUI software to controls all module's functions
- Single Power supply (12V or 24V)
- A wide range trigger oscillator and diverse triggering features.
- Save / retrieve waveform function
- Safety features: Interlock/Key input and quick shut-down from the GUI
- Compact: 70mm x 60mm

Product Applications

- Seed laser for fiber lasers
- Optical pulser for LRF or LIDAR target simulators

- 3D Vision systems
- Pico-second to nanosecond pulsers for lab use

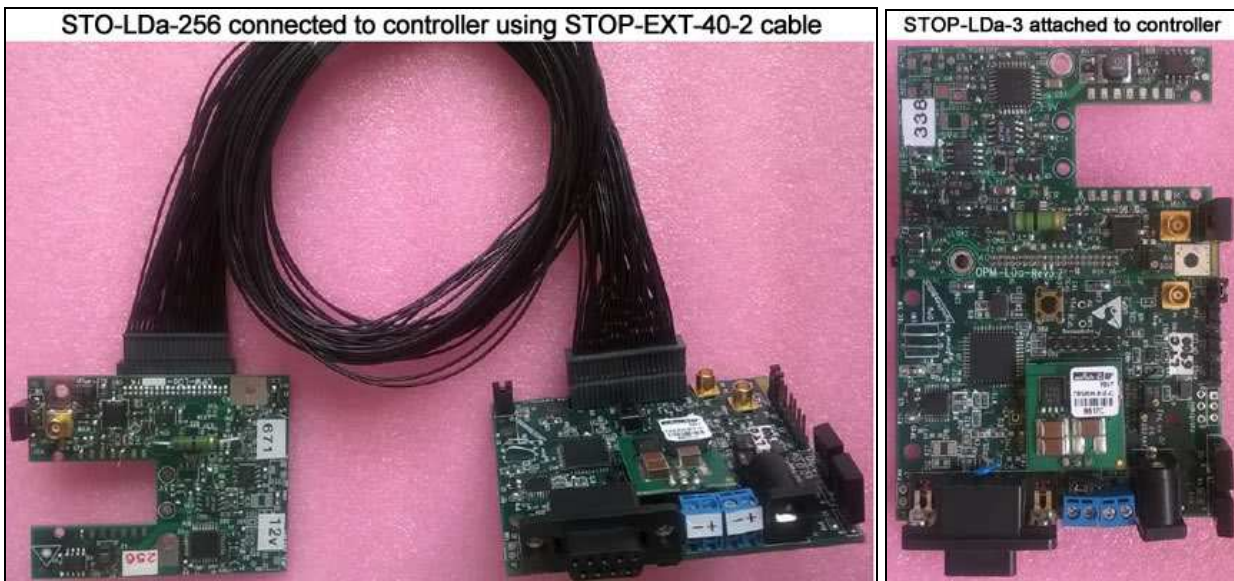

The GUI software controls all the functions of the STOP-LD module and displays status/monitoring data. It includes tens of pre-set values of pulse-width, frequencies, bias currents, Peak currents and LD temperatures. The GUI also allows the user to save and retrieve waveforms.

A special attention was made to safety features: Interlock input, Key input and a one touch quick shut-down from the GUI.

Attaching the controller to an STOP-LD board forms one board with total dimensions of ~7X10 cm. The user may also connect the two boards by using a cable. The two boards can also be attached to form a (sandwich) having dimensions of 70mm x 60mm.

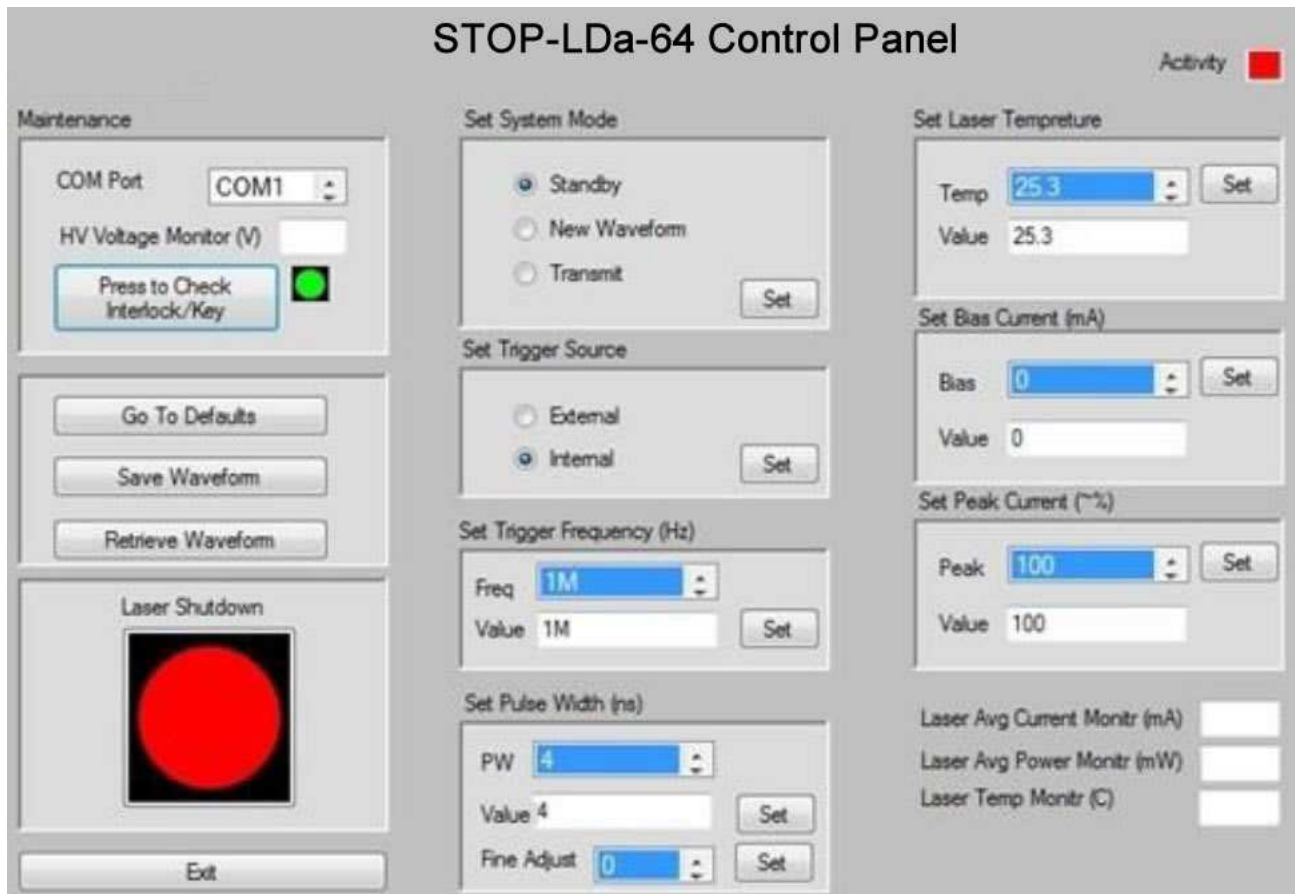

Ordering codes:

- STOP-CSW-64 Controller/SW for STOP-LDa-64
- STOP-CSW-256 Controller/SW for STOP-LDa-256
- STOP-CSW-1250 Controller/SW for STOP-LDa-1250
- STOP-CSW-3 Controller/SW for STOP-LDa-3 and STOP-LDa-gs

STJ Series Laser Diode Drivers

1. CW Laser Diode Drivers (Intelligent Module)

The CW Laser diode driver is specially designed for various CW laser diodes at the compact size and modularization. It adopts the latest modern power electronic devices, high-speed microprocessor (MPU) program control technology, and low-power linear modulation technology (with extremely low ripple). It has excellent voltage and current output characteristics. No overshoot, no kickback, no surge and low noise in operation. It has perfect multiple protection functions, and has reliable protection for laser diode. The adjustment and control of current parameters can be selected by local and computer (set by software). In addition, the driver also has alarm signal settings. (eg. water pressure alarm, for shutdown protection). The driver adopts 16 bit "8" LED, simple menu mode display, membrane button, and has friendly user interface and fault diagnosis function. And TEC for precision maintaining the temperature on Peiltier element (TEM) is also an optional.

The CW laser diode driver is an excellent choice for laser equipment manufactures and research institute.



Features:

- Adaptive load, real-time display of actual voltage;
- 0-300A (The output current is continuously adjustable), real time display of the current & electric power;
- Pulse function available ($\leq 10\text{Hz}$, need to be customized for this function);
- Rise time $\geq 200\text{ms}$, fall time $\geq 200\text{ms}$;
- Local & remote computer control;
- Local and remote computer control for power on / off;
- With input alarm signal (eg. water pressure alarm for shutdown protection);
- Over heat, over current protections;
- High stability, high anti-interference and low noise;
- 16 bit "8" digital tube display to show setting current, actual voltage and output power, simple menu / mode display, membrane button;
- RS232 and communication protocol controls (optional);
- User friendly interface, fault diagnosis function;
- Optional: TEC controller (output max. 200W and $< 48\text{VDC}$);
- We can customize the driver according to customer's requirements.

Model	STJ-CW0330 STJ-CW0340 STJ-CW0350	STJ-CW0360 STJ-CW0375	STJ-CW03100 STJ-CW03150 STJ-CW03300	STJ-CW0630 STJ-CW0640	STJ-CW0660 STJ-CW0680	STJ-CW06100 STJ-CW06125 STJ-CW06250	STJ-CW1225 STJ-CW1235
Input voltage (VAC)	220 \pm 15%	220 \pm 15%	220 \pm 15%	220 \pm 15%	220 \pm 15%	220 \pm 15%	220 \pm 15%
Output voltage(V)	3V (self-adaption)	3V (self-adaption)	3V (self-adaption)	6V (self-adaption)	6V (self-adaption)	6V (self-adaption)	12V (self-adaption)
Output current(A)	0-30A 0-40A 0-50A	0-60A 0-75A	0-100A 0-150A 0-300A	0-30A 0-40A	0-60A 0-80A	0-100A 0-125A 0-250A	0-25A 0-35A
Voltage noise (Vp-p)	$\leq 0.1\%$	$\leq 0.1\%$	$\leq 0.1\%$	$\leq 0.1\%$	$\leq 0.1\%$	$\leq 0.1\%$	$\leq 0.1\%$
Current noise (Ap-p)	$\leq 0.1\%$	$\leq 0.1\%$	$\leq 0.1\%$	$\leq 0.1\%$	$\leq 0.1\%$	$\leq 0.1\%$	$\leq 0.1\%$

Stability%)	≤0.1	≤0.1	≤0.1	≤0.1	≤0.1	≤0.1	≤0.1
Working Mode(CW/QCW)	CW	CW	CW	CW	CW	CW	CW
(LCD/LED)	LED	LED	LED	LED	LED	LED	LED
Working temperature (°C)	-20~+50	-20~+50	-20~+50	-20~+50	-20~+50	-20~+50	-20~+50
Environment humidity (%)	≤90	≤90	≤90	≤90	≤90	≤90	≤90

Model	STJ-CW1250 STJ-CW1280 STJ-CW12125	STJ-CW1520 STJ-CW1530	STJ-CW1540 STJ-CW1565 STJ-CW15100	STJ-CW2425 STJ-CW2430 STJ-CW2440 STJ-CW2460	STJ-CW3020 STJ-CW3032 STJ-CW3050	STJ-CW5012 STJ-CW5020 STJ-CW5030	STJ-CW6010 STJ-CW6016 STJ-CW6025
Input voltage (VAC)	220±15%	220±15%	220±15%	220±15%	220±15%	220±15%	220±15%
Output voltage(V)	12V (self-adaption)	15V (self-adaption)	15V (self-adaption)	24V (self-adaption)	30V (self-adaption)	50V (self-adaption)	60V (self-adaption)
Output current(A)	0-50A 0-80A 0-125A	0-20A 0-30A	0-40A 0-65A 0-100A	0-25A 0-30A 0-40A 0-60A	0-20A 0-32A 0-50A	0-12A 0-20A 0-30A	0-10A 0-16A 0-25A
Voltage noise (Vp-p)	≤0.1%	≤0.1%	≤0.1%	≤0.1%	≤0.1%	≤0.1%	≤0.1%
Current noise (Ap-p)	≤0.1%	≤0.1%	≤0.1%	≤0.1%	≤0.1%	≤0.1%	≤0.1%
Stability%)	≤0.1	≤0.1	≤0.1	≤0.1	≤0.1	≤0.1	≤0.1
Working mode(CW/QCW)	CW	CW	CW	CW	CW	CW	CW
(LCD/LED)	LED	LED	LED	LED	LED	LED	LED
Working temperature (°C)	-20~+50	-20~+50	-20~+50	-20~+50	-20~+50	-20~+50	-20~+50
Environment humidity (%)	≤90	≤90	≤90	≤90	≤90	≤90	≤90

Remarks:

- If you want 110VAC input power supply, please inform us when ordering
- We have two sizes of the drivers: W×L×H=170×320×75mm (M1;W×L×H=220×320×75mm (M2)
- Above drivers are our standard models. We can also customize according to customer's parameters.

2. CW Laser Diode Drivers (High Power)

The CW laser diode driver is specially design for HP (300-3000W) laser diodes at standard 2U & 3U sizes. It adopts the latest modern power electronic devices, high-speed microprocessor (MPU) program control technology, and low-power linear modulation technology (with extremely low ripple). It has excellent voltage and current output characteristics. No overshoot, no kickback, no surge and low noise when operation. It has perfect multiple protection functions, and has reliable protection for laser diode. The adjustment and control of current parameters can be selected by local and computer (set by software). In addition, the driver also has alarm signal settings. (eg. water pressure alarm for shutdown protection). The driver adopts 16 bit "8" digital tube display, simple menu mode display, membrane button, and has friendly user interface and fault diagnosis function. And TEC for precision maintaining the temperature on peiltier element (TEM) is also an optional.

The CW laser diode driver is an excellent choice for laser equipment manufactures and research institute.



Features:

- Adaptive load, real-time display of actual voltage;
- 0-300A (The output current is continuously adjustable), real time display of the current & electric power;
- Pulse function available ($\leq 10\text{Hz}$, need to be customized for this function);
- Rise time $\geq 200\text{ms}$, Fall time $\geq 200\text{ms}$;
- Local & computer control;
- Local and computer control for power on / off;
- With input alarm signal (eg. water pressure alarm for shutdown protection);
- Over heat, over current protections;
- High stability, high anti-interference and low noise
- 16 bit "8" digital tube display, to show setting current, actual current, voltage and power, simple menu / mode display, membrane button;
- RS232 and communication protocol controls (optional);
- User friendly interface, fault diagnosis function;
- TEC (optional)
- We can customize the driver according to customer's requirements.

Model	STJ-CW03100 STJ-CW03150 STJ-CW03300	STJ-CW0685 STJ-CW06125 STJ-CW06250	STJ-CW10100 STJ-CW10125 STJ-CW10150 STJ-CW10300	STJ-CW1285 STJ-CW12125 STJ-CW12250	STJ-CW2450 STJ-CW2480 STJ-CW24125
Input voltage (VAC)	220 \pm 15%	220 \pm 15%	220 \pm 15%	220 \pm 15%	220 \pm 15%
Output voltage(V)	3V(self-adaption)	6V(self-adaption)	10V(self-adaption)	12V(self-adaption)	24V(self-adaption)
Output current(A)	0-100A 0-150A 0-300A	0-85A 0-125A 0-250A	0-100A 0-125A 0-150A 0-300A	0-85A 0-125A 0-250A	0-50A 0-80A 0-125A
Voltage noise (Vp-p)	$\leq 0.1\%$	$\leq 0.1\%$	$\leq 0.1\%$	$\leq 0.1\%$	$\leq 0.1\%$
Current noise (Ap-p)	$\leq 0.1\%$	$\leq 0.1\%$	$\leq 0.1\%$	$\leq 0.1\%$	$\leq 0.1\%$
Stability(%)	≤ 0.1	≤ 0.1	≤ 0.1	≤ 0.1	≤ 0.1

Working mode(CW/QCW)	CW	CW	CW	CW	CW
(LCD/LED)	Digital tube	Digital tube	Digital tube	Digital tube	Digital tube
Working temperature (°C)	-20~+50	-20~+50	-20~+50	-20~+50	-20~+50
Environment humidity (%)	≤90	≤90	≤90	≤90	≤90

Model	STJ-CW3040 STJ-CW3065 STJ-CW30100	STJ-CW5025 STJ-CW5040 STJ-CW5060	STJ-CW6020 STJ-CW6032 STJ-CW6050	STJ-CW10012 STJ-CW10020 STJ-CW10030	STJ-CW12010 STJ-CW12016 STJ-CW12025
Input voltage (VAC)	220±15%	220±15%	220±15%	220±15%	220±15%
Output voltage(V)	30V(self-adaption)	50V(self-adaption)	60V(self-adaption)	100V(self-adaption)	120V(self-adaption)
Output current(A)	0-40A 0-65A 0-100A	0-25A 0-40A 0-60A	0-20A 0-32A 0-50A	0-12A 0-20A 0-30A	0-10A 0-16A 0-25A
Voltage noise (Vp-p)	≤0.1%	≤0.1%	≤0.1%	≤0.1%	≤0.1%
Current noise (Ap-p)	≤0.1%	≤0.1%	≤0.1%	≤0.1%	≤0.1%
Stability(%)	≤0.1	≤0.1	≤0.1	≤0.1	≤0.1
WorkingmMode(CW/QCW)	CW	CW	CW	CW	CW
(LCD/LED)	LED	LED	LED	LED	LED
Working temperature (°C)	-20~+50	-20~+50	-20~+50	-20~+50	-20~+50
Environment humidity (%)	≤90	≤90	≤90	≤90	≤90

Remarks:

- If you need 110VAC input power supply, please inform us when ordering
- We have two sizes of the drivers: W×L×H=425×310×88mm (2U);W×L×H=425×380×132mm (3U)
- Above drivers are our standard models. We can also customized according to customer's parameters.

3. CW Laser Diode Drivers with 2 Channels TECs

The CW laser diode driver (with 2 channels TECs) is specially design for various CW laser diode at the compact size and modularization. It adopts the latest modern power electronic devices, high-speed microprocessor (MPU) program control technology, and low-power linear modulation technology (with extremely low ripple). It has excellent voltage and current output characteristics. No overshoot, no kickback, no surge and low noise when operation. It has perfect multiple protection functions, and has reliable protection for laser diode. The adjustment and control of current parameters can be selected by local and computer (set by software). In addition, the driver also has alarm signal settings. (eg. water pressure alarm, for shutdown protection). The driver adopts 16 bit "8" digital tube display, simple menu mode display, membrane button, and has friendly user interface and fault diagnosis function. And TEC for precision maintaining the temperature on peiltier element (TEM) is also an optional.

The CW laser diode driver is an excellent choice for laser equipment manufactures and research institute.



Features:

- Adaptive load, real-time display of actual voltage;
- 0-100A (The output current is continuously adjustable), real time display of the current & electric power;

- Pulse function available ($\leq 10\text{Hz}$, need to be customized for this function);
- Rise time $\geq 200\text{ms}$, fall time $\geq 200\text{ms}$;
- Local & computer control;
- Local and computer control for power on / off;
- With input alarm signal (eg water pressure alarm for shutdown protection);
- Over heat, over current protections;
- High stability, high anti-interference and low noise;
- 16 bit "8" digital tube display, to show setting current, actual current, voltage and power, simple menu / mode display, membrane button;
- RS232 and communication protocol controls (optional);
- User friendly interface, fault diagnosis function;
- We can customize the driver according to customer's requirements.

Model	STJ-CW0330	STJ-CW0340	STJ-CW0350	STJ-CW0360	STJ-CW0375	STJ-CW03100
Input voltage (VAC)	220 \pm 15%	220 \pm 15%	220 \pm 15%	220 \pm 15%	220 \pm 15%	220 \pm 15%
Output voltage(V)	3V (self-adaption)	3V (self-adaption)	3V (self-adaption))	3V (self-adaption)	3V (self-adaption)	3V (self-adaption)
Output current(A)	0-30A	0-40A	0-50A	0-60A	0-75A	0-100A
Voltage noise (Vp-p)	$\leq 0.1\%$	$\leq 0.1\%$	$\leq 0.1\%$	$\leq 0.1\%$	$\leq 0.1\%$	$\leq 0.1\%$
Current noise (Ap-p)	$\leq 0.1\%$	$\leq 0.1\%$	$\leq 0.1\%$	$\leq 0.1\%$	$\leq 0.1\%$	$\leq 0.1\%$
Stability (%)	≤ 0.1	≤ 0.1	≤ 0.1	≤ 0.1	≤ 0.1	≤ 0.1
Working mode(CW/QCW)	CW	CW	CW	CW	CW	CW
(LCD/LED)	LED	LED	LED	LED	LED	LED
Working temperature (°C)	-20~+50	-20~+50	-20~+50	-20~+50	-20~+50	-20~+50
Environment humidity (%)	≤ 90	≤ 90	≤ 90	≤ 90	≤ 90	≤ 90

Remarks:

- If you need 110VAC input power supply, please inform us when ordering
- The driver size is $W \times L \times H = 425 \times 380 \times 132\text{mm}$ (3U)
- Above drivers are our standard models. We can also customize according to customer's parameters.

4. QCW Laser Diode Drivers

The QCW Laser diode driver is specially designed for various QCW laser diodes at the compact size and modularization. It adopts the latest modern power electronic devices, high-speed microprocessor (MPU) program control technology, and low-power linear modulation technology (with extremely low ripple). It has excellent voltage and current output characteristics. No overshoot, no kickback, no surge and low noise when operation. It has perfect multiple protection functions, and has reliable protection for laser diode. The adjustment and control of current parameters can be selected by local and computer (setting by software). In addition, the driver also has alarm signal settings. (eg. water pressure alarm, for shutdown protection). The driver adopts 240x128 dot matrix graphic LCD or 16 bit "8" digital tube display, simple menu mode display, membrane button, and has friendly user interface and fault diagnosis function. And TEC for precision maintaining the temperature on peltier element (TEM) is also an optional.

The QCW laser diode driver is an excellent choice for laser equipment manufactures and research institute. It can set the temperature parameters independently and you can also set the temperature on the LCD only via a serial line to connect to the laser driver.



Features:

- Ideal rectangle output pulse current waveform;
- The max output voltage 50V (adaptive load)
- Adaptive load, real-time display of actual voltage;
- 0-150A (The output current is continuously adjustable), QCW output;
- Pulse frequency 1-2000Hz (adjustable). The Max 5kHz (When the duty cycle =50%, need to customized);
- Pulse width 20-500us (adjustable) (Need to customized if the pulse width >1000us);
- Pulse duty cycle 0-25% (max) adjustable.(Need to customized if the duty cycle >25%);
- Local & computer control for the pulse current;
- Local & computer control for the pulse frequency;
- Local & computer control for the pulse width;
- Local and computer control for power on / off;
- A 400million times counting ability pulse counter PC, which is used to count the output pulse (only for Y1 and Y2 models);
- High speed ,rapidly adjusted the current value of each pulse one by one;
- Delay synchronization signal output with 0-6000us delay and adjustment step size at 1us;
- With input alarm signal (eg. water pressure alarm, for shutdown protection);
- Over heat, over current protections;
- High stability, high anti-interference and low noise;
- 240x28 dot matrix graphic LCD or 16 bit "8" digital tube display, to show setting current, actual current, voltage and power, simple menu / mode display, membrane button
- User friendly interface, fault diagnosis function
- With perfect PID control software, intelligent step-less temperature control on both heating and cooling, TEC laser diode driver is an good optional for better laser performance and compact size for the user.
- We can customize the driver according to customer's requirements.

Model	STJ-QCW 03100	STJ-QCW 03120	STJ-QCW 03150	STJ-QCW 06100	STJ-QCW 06120	STJ-QCW 06150	STJ-QCW 12100
Input voltage (VAC)	220±15%	220±15%	220±15%	220±15%	220±15%	220±15%	220±15%
Output voltage(V)	3V (self- adaption)	3V (self- adaption)	3V (self- adaption)	6V (self- adaption)	6V (self- adaption)	6V (self- adaption)	6V (self- adaption)
Output current(A)	0-100A	0-120A	0-150A	0-100A	0-120A	0-150	0-100A
Frequency(Hz)	1-2000	1-2000	1-2000	1-2000	1-2000	1-2000	1-2000
Pulse width(us)	20-500	20-500	20-500	20-500	20-500	20-500	20-500
Duty cycle(%)	≤25	≤25	≤25	≤25	≤25	≤25	≤25
Average output power	≤75W	≤90W	≤110W	≤150W	≤180W	≤225W	≤300W
Rise/Fall time(us)	≤20/15	≤20/15	≤20/15	≤20/15	≤20/15	≤20/15	≤20/15
Synchronous signal (us)	0-1000	0-1000	0-1000	0-1000	0-1000	0-1000	0-1000

Voltage noise (Vp-p)	≤0.1%	≤0.1%	≤0.1%	≤0.1%	≤0.1%	≤0.1%	≤0.1%
Current noise (Ap-p)	≤50mA	≤60mA	≤70mA	≤50mA	≤60mA	≤70mA	≤50mA
Stability(%)	≤0.1	≤0.1	≤0.1	≤0.1	≤0.1	≤0.1	≤0.1
Working mode(CW/QCW)	QCW	QCW	QCW	QCW	QCW	QCW	QCW
(LCD/LED)	LCD/LED	LCD/LED	LCD/LED	LCD/LED	LCD/LED	LCD/LED	LCD/LED
Working temperature (°C)	-20~+50	-20~+50	-20~+50	-20~+50	-20~+50	-20~+50	-20~+50
Environment humidity (%)	≤90	≤90	≤90	≤90	≤90	≤90	≤90

Model	STJ-QCW 12150	STJ-QCW 24100	STJ-QCW 24150	STJ-QCW 30100	STJ-QCW 30150	STJ-QCW 50100	STJ-QCW 50150
Input voltage (VAC)	220±15%	220±15%	220±15%	220±15%	220±15%	220±15%	220±15%
Output voltage(V)	12V (self-adaption))	24V (self-adaption))	24V (self-adaption))	30V (self-adaption))	30V (self-adaption))	50V (self-adaption))	50V (self-adaption))
Output current(A)	0-150A	0-100A	0-150A	0-100A	0-150A	0-100A	0-150A
Frequency(Hz)	1-1600	1-1200	1-800	1-1000	1-700	1-700	1-500
Pulse width(us)	20-500	20-500	20-500	20-500	20-500	20-500	20-500
Duty cycle(%)	≤16	≤12	≤8	≤10	≤7	≤7	≤5
Average output power	≤290W	≤290W	≤290W	≤300W	≤315W	≤350W	≤375W
Rise/fall time(us)	≤20/15	≤20/15	≤20/15	≤20/15	≤20/15	≤25/20	≤25/20
Synchronous signal (us)	0-1000	0-1000	0-1000	0-1000	0-1000	0-1000	0-1000
Voltage noise (Vp-p)	≤0.1%	≤0.1%	≤0.1%	≤0.1%	≤0.1%	≤0.1%	≤0.1%
Current noise (Ap-p)	≤70mA	≤60mA	≤70mA	≤60mA	≤70mA	≤70mA	≤50mA
Stability(%)	≤0.1	≤0.1	≤0.1	≤0.1	≤0.1	≤0.1	≤0.1
Working mode(CW/QCW)	QCW	QCW	QCW	QCW	QCW	QCW	QCW
(LCD/LED)	LCD/LED	LCD/LED	LCD/LED	LCD/LED	LCD/LED	LCD/LED	LCD/LED
Working temperature (°C)	-20~+50	-20~+50	-20~+50	-20~+50	-20~+50	-20~+50	-20~+50
Environment humidity (%)	≤90	≤90	≤90	≤90	≤90	≤90	≤90

Remarks:

- If you need 110VAC input power supply, please inform us when ordering
- We have four sizes of the drivers W×L×H=304×295×88mm (Y1, S1);W×L×H=425×310×88mm (Y2, S2);
- Above drivers are our standard models. We can also customize according to customer's parameters.
- We can customized the driver with adjustable pre-current (It is also known as preheating current, maintaining current, base current).

5. TEC Drivers

The TEC driver is a high-performance temperature control system (air cooling) specially designed for driving laser diode (thermoelectric refrigeration chip, TEC), with high precision and high stability. It is based on the principle of Peltier effect. It has the advantages of high precision, long service life, small volume, no noise, no wear, no vibration, no pollution. The TEC driver has perfect PID control software and intelligent stepless temperature control, which can both cooled and heated. It can control by RS232 / 485 serial communication interface and communication protocol.

It can also supplies 1-2 channels of TEC control output, which can be used to control laser, medical devices, diode, infrared detectors, photomultiplier tubes, or any other devices which need the temperature control.

The TEC driver adopts the latest modern power electronic devices, high-speed microprocessor (MPU) program control technology, as well as PWM modulation, bidirectional power supply and PID regulation technology. It has excellent voltage and current output characteristics. No overshoot, no kickback, no surge and low noise when



operation.

It also has over-current, over temperature and under temperature protection circuits, as well as a set of normally open / normally closed temperature alarm signal output.

The driver adopts 16 bit "8" LED, simple menu mode display, membrane button, and has friendly user interface and fault diagnosis function.

It is an excellent choice for laser equipment manufactures, research institute and personal. We used the standard PT1000 temperature sensor (platinum resistance) to have the best precision, linearity and stability.

Features:

- Intelligent step-less temperature regulation, two-way temperature control (both cooling and heating)
- Temperature accuracy $\pm 0.1^{\circ}\text{C}$
- Normally operating temperature range ($0^{\circ}\text{C} - 80^{\circ}\text{C}$ adjustable) (other ranges can be customized)
- Temperature alarm when exceeds the upper / lower limit
- The user can modify the temperature PID feedback parameters (but usually use the System Default PID parameters or the self- calibrated PID parameters)
- Three constant temperature mode selection: (1) standard cold and hot constant temperature (default), (2) cooling constant temperature, (3) heating constant temperature
- Automatic calibration of PID parameters of the temperature
- RS232/485 communication protocol (optional)
- With a set of normally open / close temperature alarm signal output
- With temperature ready signal output
- Over heat, over current protections; over/under temperature protection circuit
- High stability, high anti-interference ,entirely eliminate 50 / 60Hz frequency interference
- 8/16 bit "8" LED, simple menu / mode display, membrane button
- User friendly interface, fault diagnosis function
- We can customize the driver according to customer's requirements

Model	STJ-JT0605	STJ-JT0610	STJ-JT0615	STJ-JT0620	STJ-JT1205	STJ-JT1210
Temperature range ($^{\circ}\text{C}$)	0~80 (or customized)	0~80 (or customized)	0~80 (or customized)	0~80 (or customized)	0~80 (or customized)	0~80 (or customized)
Temperature accuracy ($^{\circ}\text{C}$)	± 0.1	± 0.1	± 0.1	± 0.1	± 0.1	± 0.1
Temperature stability ($^{\circ}\text{C}$)	≤ 0.1	≤ 0.1	≤ 0.1	≤ 0.1	≤ 0.1	≤ 0.1
Adjustment cycle (s)	0.1	0.1	0.1	0.1	0.1	0.1
Input voltage(VAC)	12VDC (220V \pm 15%)	12VDC (220V \pm 15%)	12VDC (220V \pm 15%)	12VDC (220V \pm 15%)	12VDC (220V \pm 15%)	12VDC (220V \pm 15%)
Output voltage (V)	0-6	0-6	0-6	0-6	0-12	0-12
Output current (A)	0-5	0-10	0-15	0-20	0-05	0-10
Voltage noise (Vp-p)	$\leq 0.5\%$	$\leq 0.5\%$	$\leq 0.5\%$	$\leq 0.5\%$	$\leq 0.5\%$	$\leq 0.5\%$
Current noise (Ap-p)	$\leq 10\text{mA}$	$\leq 20\text{mA}$	$\leq 30\text{mA}$	$\leq 40\text{mA}$	$\leq 10\text{mA}$	$\leq 20\text{mA}$
Stability(%)	≤ 0.1	≤ 0.1	≤ 0.1	≤ 0.1	≤ 0.1	≤ 0.1
(LCD/LED)	LED	LED	LED	LED	LED	LED
Working temperature ($^{\circ}\text{C}$)	-20~+40	-20~+40	-20~+40	-20~+40	-20~+50	-20~+40
Environment humidity (%)	≤ 90	≤ 90	≤ 90	≤ 90	≤ 90	≤ 90

Model	STJ-JT1215	STJ-JT1220	STJ-JT2405	STJ-JT2410	STJ-JT3606	STJ-JT4805
Temperature range ($^{\circ}\text{C}$)	0~80 (or customized)	0~80 (or customized)	0~80 (or customized)	0~80 (or customized)	0~80 (or customized)	0~80 (or customized)
Temperature accuracy ($^{\circ}\text{C}$)	± 0.1	± 0.1	± 0.1	± 0.1	± 0.1	± 0.1
Temperature stability ($^{\circ}\text{C}$)	≤ 0.1	≤ 0.1	≤ 0.1	≤ 0.1	≤ 0.1	≤ 0.1
Adjustment cycle (s)	0.1	0.1	0.1	0.1	0.1	0.1
Input voltage(VAC)	12VDC (220V \pm 15%)	12VDC (220V \pm 15%)	24VDC (220V \pm 15%)	24VDC (220V \pm 15%)	36VDC (220V \pm 15%)	48VDC (220V \pm 15%)
Output voltage (V)	0-12	0-12	0-24	0-24	0-36	0-48
Output Current (A)	0-15	0-20	0-05	0-10	0-6	0-5
Voltage Noise(Vp-p)	$\leq 0.5\%$	$\leq 0.5\%$	$\leq 0.5\%$	$\leq 0.5\%$	$\leq 0.5\%$	$\leq 0.5\%$
Current noise (Ap-p)	$\leq 30\text{mA}$	$\leq 40\text{mA}$	$\leq 15\text{mA}$	$\leq 30\text{mA}$	$\leq 15\text{mA}$	$\leq 20\text{mA}$
Stability(%)	≤ 0.1	≤ 0.1	≤ 0.1	≤ 0.1	≤ 0.1	≤ 0.1
(LCD/LED)	LED	LED	LED	LED	LED	LED
Working temperature ($^{\circ}\text{C}$)	-20~+40	-20~+40	-20~+40	-20~+40	-20~+40	-20~+40
Environment humidity (%)	≤ 90	≤ 90	≤ 90	≤ 90	≤ 90	≤ 90

Remarks:

- If needs 48VDC or 110VAC power supply, please inform us when ordering
- the driver size $W \times L \times H = 215 \times 115 \times 50$ mm (Modular, 12~36VDC)
- Above drivers are our standard models. We can also customize according to customer's parameters.

6. TE Coolers and Temperature Sensors

(1) Laser Diode Cooling Modules

The laser diode cooling module (thermal electric cooler) is designed for maximize the cooling capacity. It adopts high density semiconductor device arrangement that makes to get higher cooling power and efficiency abilities at the same substrate size. This high cooling density makes the heat exchanger more compact and more efficient.

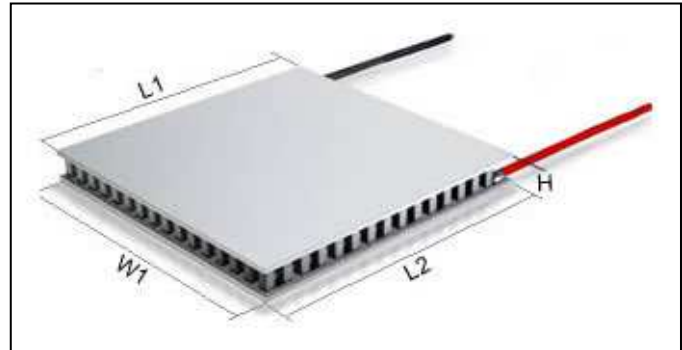

Model	I _{max} (A)	V _{max} (V)	T _{max} (°C)	Q _{cmax} (W)	W1	L1	L2	H
STJ-9500/241/060B	6.0	33.1	72	108	55.0	55.0	—	4.16
STJ-9500/241/085B	8.5	33.1	72	153	55.0	55.0	—	3.94
STJ-9500/391/085B	8.5	53.8	72	248	55.0	55.0	—	3.35
STJ-9500/199/100B	10.0	27.4	72	148	40.0	40.0	—	3.35
STJ-9500/241/100B	10.0	33.1	72	180	55.0	55.0	—	3.64
STJ-9500/337/100B	10.0	46.4	72	252	55.0	55.0	—	3.35
STJ-9500/127/120B	12.0	17.5	72	114	39.7	39.7	—	3.45
STJ-9505/127/150B	15.0	17.5	72	142	40.0	40.0	—	3.45
STJ-9500/131/150B	15.0	18.0	72	147	30.0	60.0	—	3.45
STJ-9501/242/160B	16.0	33.3	72	289	55.0	55.0	58.0	3.45
STJ-9506/031/600B	60.0	4.3	72	139	55.0	55.0	—	4.85

(2) PT1000 Temperature Sensors

The PT resistance temperature sensor is made by using the physical characteristics of platinum which can change with temperature and has good reproducibility and stability.

The resistance value of PT1000 temperature sensor is 1000 Ω at the temperature 0°C. And it will be 1385.1 Ω at 100°C, Thus, the resistance change rate is 3.851 Ω /°C.

PT resistance temperature sensor has high precision, good stability and wide temperature range application. It is the most popularly used in temperature detector in the range from 200 to 650°C. It is not only widely used in industrial temperature measurement, but also into various standard thermometers for measurement and calibration. (covering national and world reference temperatures). PT1000 sensor has good long-term stability. The typical experimental data: The max temperature drift is only 0.02°C at 0°C after 300 hours continues working at 400.

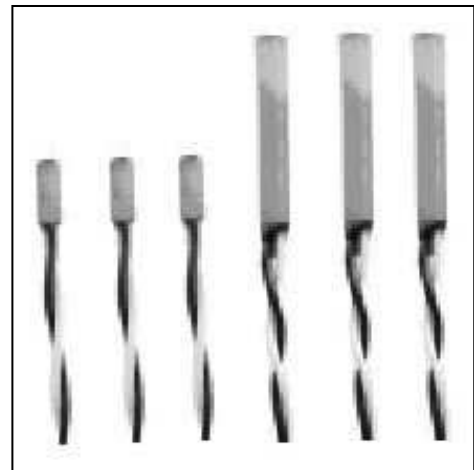

Model	Standard resistance value at 0°C	Standard resistance value at 100°C
PT100	100.00 Ω	138.51 Ω
PT1000	1000.0 Ω	1385.1 Ω

STSF Series Laser Diode Drivers

Laser diode driver / laser diode controller is a current source that delivers exactly the current to the laser diode that it needs to operate for a particular application. It is very important for laser diode module to provide current signal without any overshooting. Our laser drivers are highly stable precise solution with integrated over current protection. It allows us to drive your laser diode absolutely safety.

Now we have two main product lines:

- STSF6XXX - powerful OEM CW compact laser diode driver;
- STSF8XXX - ultra-compact OEM driver for butterfly laser diode with TEC.

STSF6XXX series includes highly current laser driver STSF6250 with output current up to 250A for laser diode bar and high current fiber-coupled module and high voltage laser driver STSF6100 with output voltage up to 40V which perfectly allows to operate with multiple single emitters fiber coupled laser diodes.

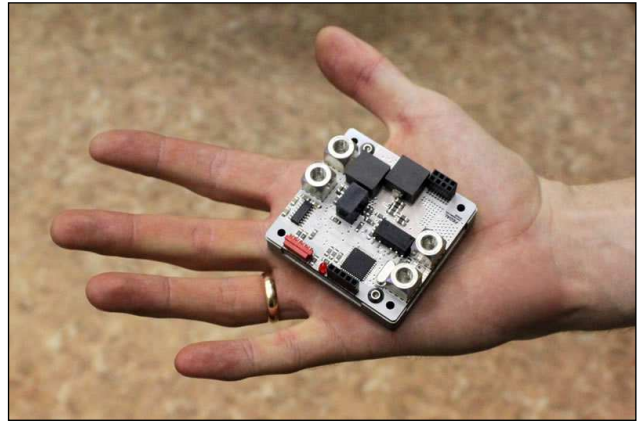

Drivers STSF8XXX include highly stable current source (0.01A) for laser diode and TEC temperature controller for precision maintaining the temperature on peltier element (TEM) (0.01°C). Also drivers have large heat sink for stable heat dissipation.

1. STSF6xxx Series Laser Diode Drivers

STSF6XXX is the series of high power, compact OEM constant current laser diode drivers. Unique laser driver circuit solutions allows to achieve high efficiency (up to 97%) and high power density. Aluminum base plate provides effective remove heat from laser diode driver module with the water or air cooling. Laser current driver have generous amount of protection features for laser diode safety operating. The main fields of application for high power laser drivers STSF6XXX is laser marking, welding, soldering, and cutting applications, medical equipment, laser measurement equipment, spectrometers, lidar, range finders and laboratory test set-ups.

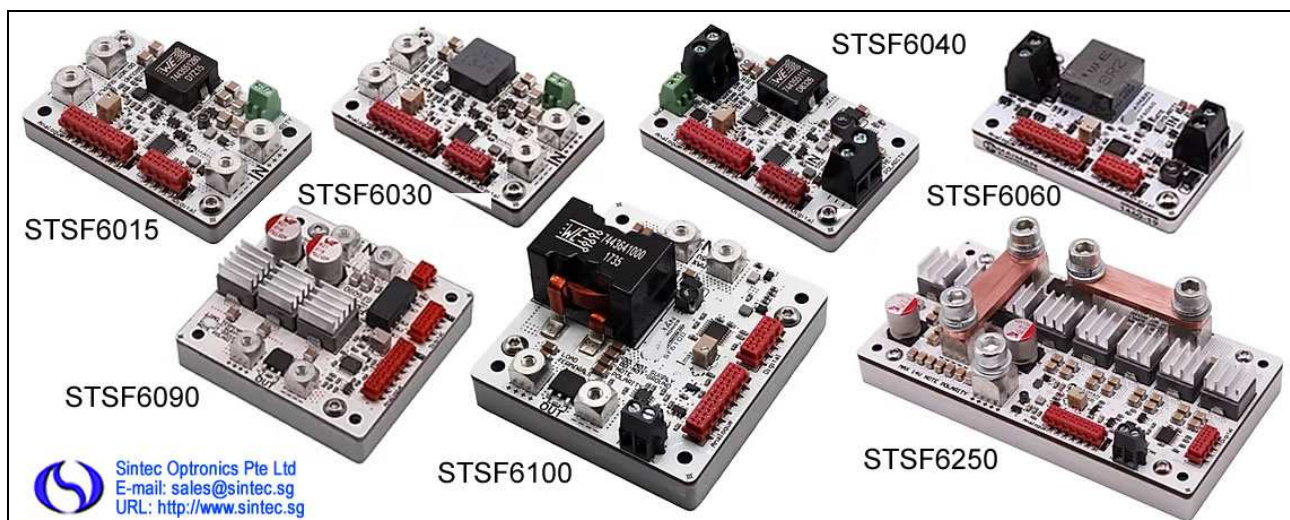

- Ultra-compact and minimum size is 57.9x36.8x15 mm
- Very high efficiency up to 97%
- NTC thermistor input (for shutdown driver when the laser diode was overheating)
- Analog control signal/ RS-232 / UART (USB as a paid option 20 €)
- Soft-start current ramp to user set-point
- Possibility to calibrate current within 5%
- Multiple layers of laser diode protection
- Free software

Part No.	STSF6015	STSF6030	STSF6040	STSF6060	STSF6090	STSF6100	STSF6250
Max. output current, A	15	30	10	15	100	25	250
Output voltage range, V	1-10	1-10	5-40	5-40	1-10	5-40	1-10
Setpoint Resolution, A	0.01	0.01	0.01	0.01	0.03	0.01	0.1
Rise Time (at 50%), us	150-500	300-700	60-100	60-100	800-1200	140-300	300-800
Rise Time (at 100%), us	140-500	30-600	60-100	60-100	700-1000	130-250	250-650
Fall time, us	250-1200	300-1500	20-80	30-80	1000-1800	10-50	400-1200
Current stability, %	<0.2	<0.2	<0.2	<0.2	<0.2	<0.2	<0.2
Dimension, mm	58x37x15	58x37x15	58x37x21	58x37x21	61x58x24	61x58x30	117x61x26
Weight, g	55	55	50	60	146	162	394
Input voltage, V	10-14	10-14	12-55	12-55	10-14	12-55	10-15

Detailed Specifications of Laser Diode Controller OEM CW 15A 10V STSF6015

CURRENT & VOLTAGE

- Output Current Range (I): 0-15 Amps
- Output Voltage Range ($0.75 \cdot V_{in \max}$) (V): 1-10 Volts
- Setpoint Resolution: 0.01 Amp
- Rise Time: (Iout = 7,5A) min - 150 μ s; max - 500 μ s
- Rise Time: (Iout = 15A) min - 140 μ s; max - 500 μ s
- Fall Time: min - 250 μ s; max - 1200 μ s
- Current Stability: <0.2 %
- Current Setpoint Absolute Accuracy: <1 %

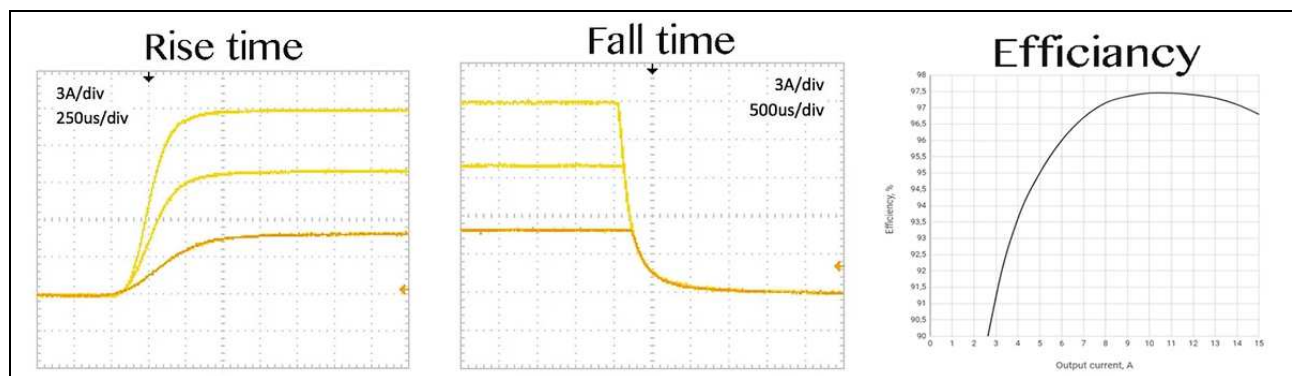

LASER DIODE PROTECTION

- Soft-Start Ramp to Current Setpoint
- User Adjustable Current Limit
- Over-Current Protection Fast Shutdown
- Over-Temperature Thermal Warning and Shutdown
- Reverse Current Protection
- Crowbar Circuit Protection
- Disable Input
- Interlock

USER INTERFACE

- Analog
- RS-232 / UART Digital Interface (USB as a paid option 20 €)
- Enable / Disable Input Signal Input

DRIVER INPUT

- Input Voltage Range (V_{in}): 10V to 14V

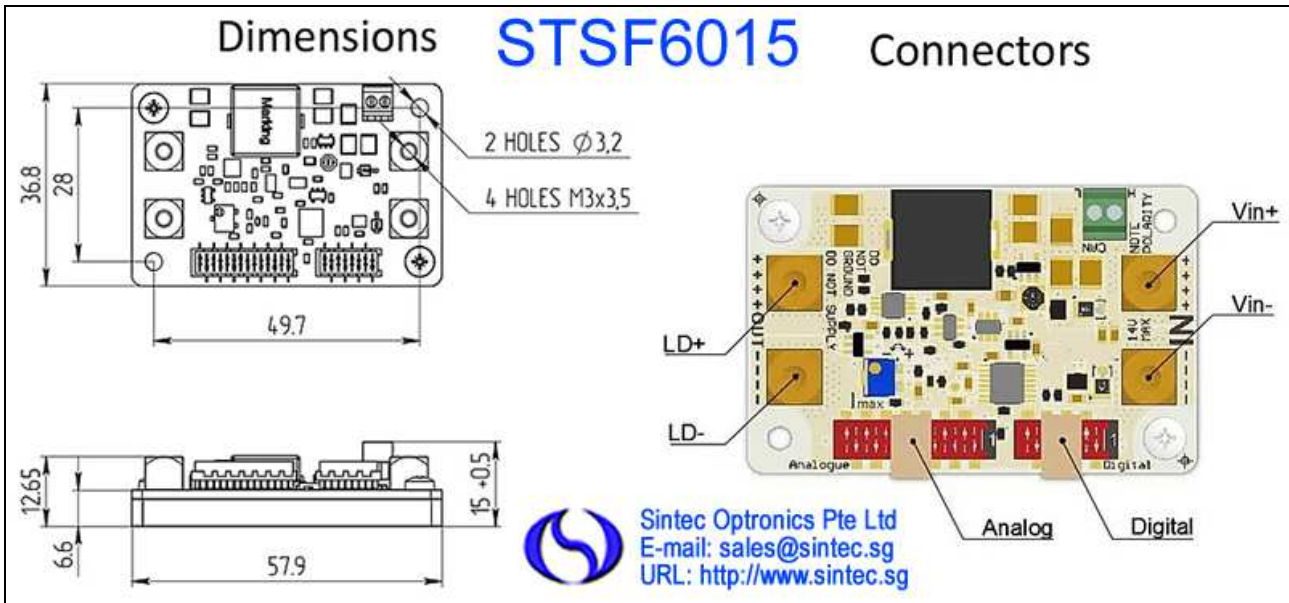

The specifications of other STSF6xxx drivers are similar to the above and not given here. Please feel free to contact us if you need any further information.

2. STSF8xxx Series Laser Diode Drivers with TEC Controllers

STSF8xxx series drivers series have special design for supply laser diode in butterfly package with 14 pin pump laser diodes. Driver include high stability current source (0.01mA) for laser diode and TEC for precision maintaining the temperature on peiltier element (TEM) (0.01 °C). Driver have an integrated mounting Azimuth socket for butterfly packaged devices and large heat sink for stable heat dissipation. The main fields of application is laser pumping, laser spectroscopy, laboratory test set-ups.

STSF8xxx contains a laser diode driver and a temperature controller (TEC). Laser diode driver is a non isolated low drop out (LDO) regulator with constant current output. Driver produces high stability and low ripple current. TEC is a non isolated DC/DC. TEC produces low current ripples. Additional features include an adjustable TEC output current limit and Integrated self-adjusted PID controller, providing optimal temperature regulation.



STSF8xxx can be controlled by analogue or digital signals and switches on the board. It is housed in 61 × 101.6 mm package with aluminum base plate to aid thermal dissipation from laser diode. The laser diode mount is located on the board. Driver can be mounted on any thermal conductive surface enough to dissipate laser diode losses.

- All-in-one current source,
- Temperature controller and mount with Azimuth ZIF socket for butterfly LD
- Compatible with Type 1 and Type 2 butterfly 14-pin laser diode (depending on the model)
- LD Low current ripple: $\leq 10\mu\text{A}$
- Current stability $< 0.1\%$
- Integrated PID controller, doesn't require setup
- Soft-start current ramp, current limit, temperature limit for laser diode protection
- Free software

Device	LDD MAX current, mA	LD mount	LD case
--------	---------------------	----------	---------

STSF8025-10	250	Soldering	10-pin Type 1
STSF8025-ZIF10	250	Plug-in connector	10-pin Type 1
STSF8025-14	250	Soldering	14-pin Type 1
STSF8025-ZIF14	250	Plug-in connector	14-pin Type 1
STSF8075-10	750	Soldering	10-pin Type 1
STSF8075-ZIF10	750	Plug-in connector	10-pin Type 1
STSF8075-14	750	Soldering	14-pin Type 1
STSF8075-ZIF14	750	Plug-in connector	14-pin Type 1
STSF8150-10	1500	Soldering	10-pin Type 1
STSF8150-ZIF10	1500	Plug-in connector	10-pin Type 1
STSF8150-14	1500	Soldering	14-pin Type 1
STSF8150-ZIF14	1500	Plug-in connector	14-pin Type 1
STSF8300-10	3000	Soldering	10-pin Type 1
STSF8300-ZIF10	3000	Plug-in connector	10-pin Type 1
STSF8300-14	3000	Soldering	14-pin Type 1
STSF8300-ZIF14	3000	Plug-in connector	14-pin Type 1

	MIN	MAX	UNIT
Vin+ to Vin-	-0.3	5.5	V
Operating temperature	-40	50	°C
Analogue control pins to GND	-0.3	5.5	V
RS-232 RXD to GND	-25	25	V
RS-232 TXD to GND	-13.2	13.2	V
UART RXD to GND	-0.3	5.5	V
UART TXD to GND	-0.3	5.5	V

2.1 Laser Diode Controller STSF8XXX-ZIF14 with TEC for Butterfly LD 14 pin

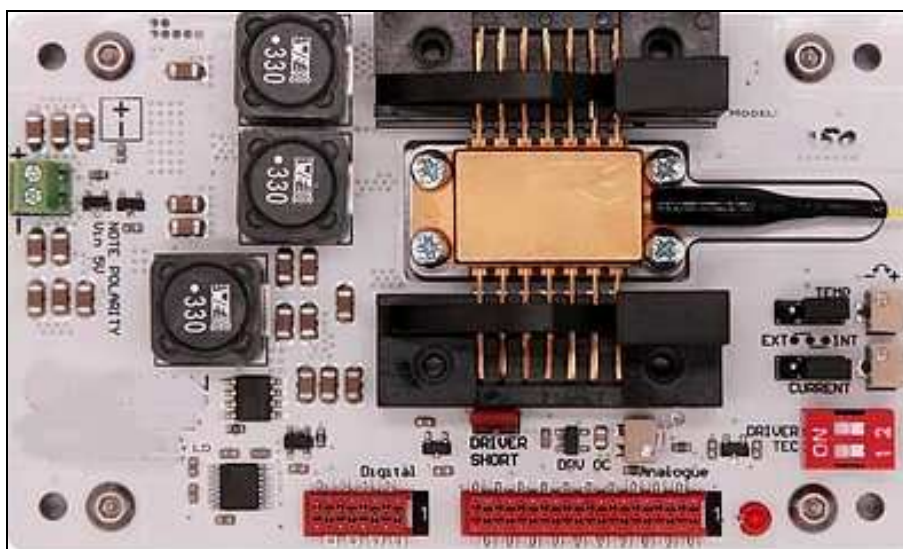

CURRENT, VOLTAGE & TEC CONTROLLER

- Maximum current LD (I): 250 mA; 750 mA; 1500 mA
- Output voltage LD (V): 0.5-3 V
- Current stability: 0.1 %

- Current set accuracy: < +/- 1 %
- Output current noise: 10-15 μ A
- TEC output power: \pm 4A
- TEC output voltage: \pm 4V
- TEC output current ripple: 2 ~ 4mA
- TEC Feedback Sensor: 10 kOhm NTC
- Temperature Control Range: +15 to +40 $^{\circ}$ C

LASER DIODE PROTECTION

- Soft-Start Current Ramp
- Current limit
- Temperature limit
- Reverse current protection
- ESD and transient protection

PINOUT

- STSF8XXX support laser diode Type 1: Pump Laser Diode
- STSF8XXXT support laser diode Type 2: Telecom Laser Diode

DIMENSIONS AND WEIGHT

- Dimensions: 101.6 x 61 x 28.3 mm
- Weight: 142 g

USER INTERFACE

- Trim Potentiometers for Driver Current and TEC Power
- Analog
- RS-232 / UART/ USB

INPUT

- Input Voltage Supply (Vin): 5 VDC

Connectors:

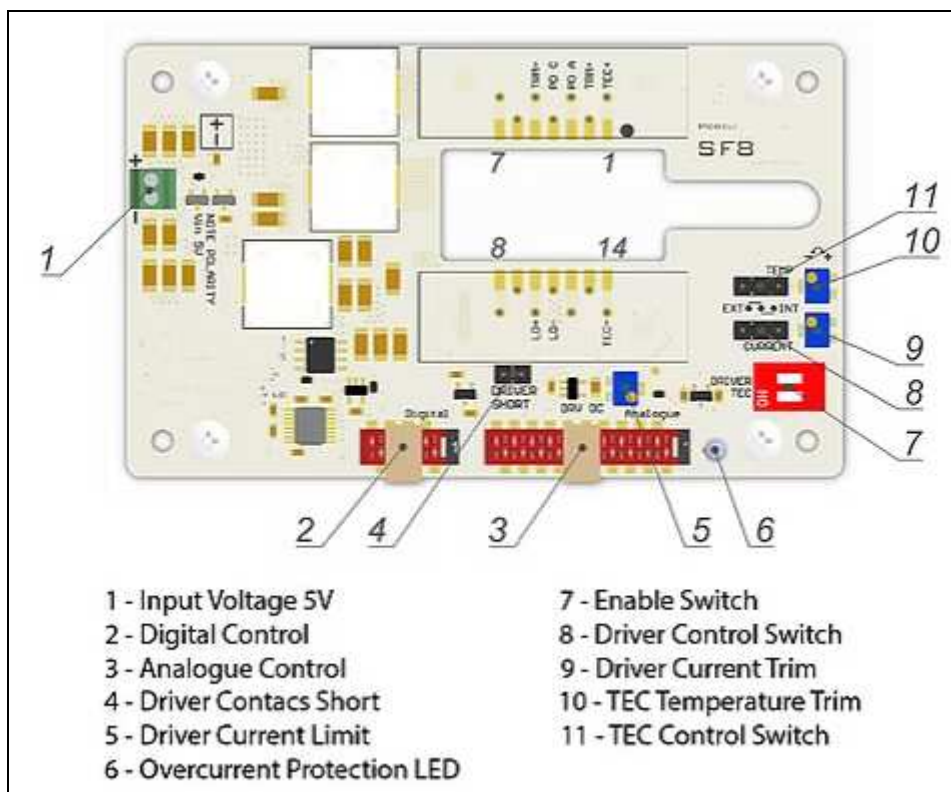

2.2 Laser Diode Driver STSF8XXX-14 with TEC for Butterfly LD 14 pin

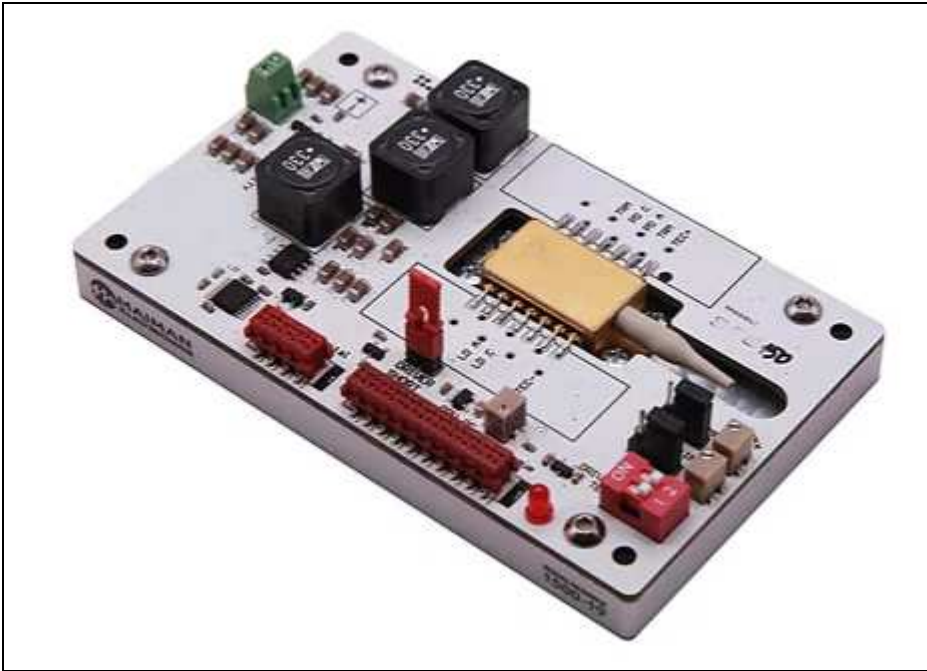

CURRENT, VOLTAGE & TEC CONTROLLER

- Maximum current LD (I): 250 mA; 750 mA; 1500 mA
- Output voltage LD (V): 0.5-3 V
- Current stability: 0.1 %
- Current set accuracy: 1 %
- Output current noise: 10-15 μ A
- TEC output power: \pm 4A
- TEC output voltage: \pm 4V
- TEC output current ripple: 2-4mA
- TEC Feedback Sensor: 10 kOhm NTC
- Temperature Control Range: +15 to +40 °C

LASER DIODE PROTECTION

- Current limit
- Temperature limit
- Reverse current protection
- ESD and transient protection
- Soft-start laser diode current ramp.

PINOUT

- STSF8XXX support laser diode Type 1: pump laser diode
- STSF8XXXT support laser diode Type 2: telecom laser diode

DIMENSIONS AND WEIGHT

- Dimensions 101.6 x 61 x 20 mm
- Weight: 136 g

USER INTERFACE

- Trim potentiometers for driver Current and TEC power
- Analog
- RS-232 / UART digital interface (USB as a paid option 20 €)

INPUT

- Input voltage range (V_{in}): 5 V

Connectors:

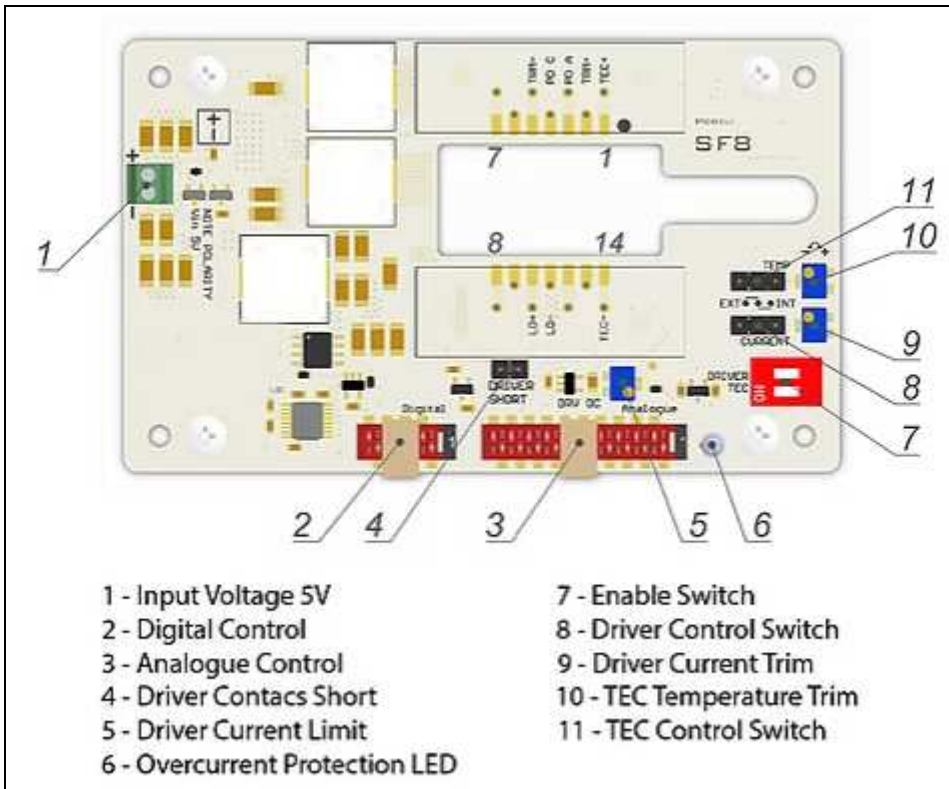

2.3 Laser Diode Driver STSF8XXX-10 with TEC for Butterfly LD 10 pin

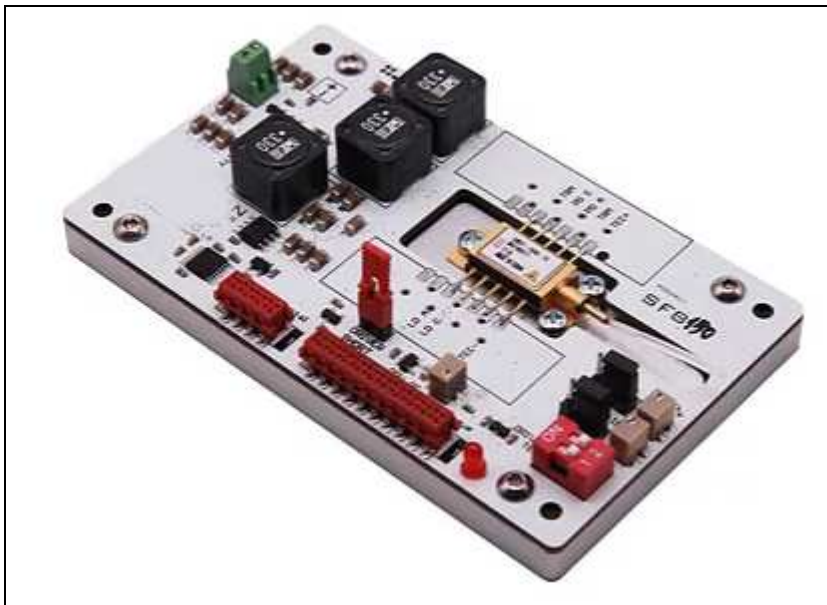

CURRENT, VOLTAGE & TEC CONTROLLER

- Maximum current LD (I): 250 mA; 750 mA; 1500 mA
- Output voltage LD (V): 0.5-3 V
- Current stability: 0.1 %
- Current set accuracy: 1 %
- Output current noise: 10-15 μ A
- TEC output power: \pm 4A
- TEC output voltage: \pm 4V
- TEC output current ripple: 2-4mA
- TEC Feedback Sensor: 10 kOhm NTC
- Temperature Control Range: +15 to +40 $^{\circ}$ C

LASER DIODE PROTECTION

- Current limit

- Temperature limit
- Reverse current protection
- ESD and transient protection
- Soft-start laser diode current ramp.

DIMENSIONS AND WEIGHT

- Dimensions 101.6 x 61 x 18.56 mm
- Weight: 119 g

USER INTERFACE

- Trim Potentiometers for Driver Current and TEC Power
- Analog
- RS-232 / UART Digital Interface (USB as a paid option 20 €)

INPUT

- Input voltage range (Vin): 5 V

Connectors:

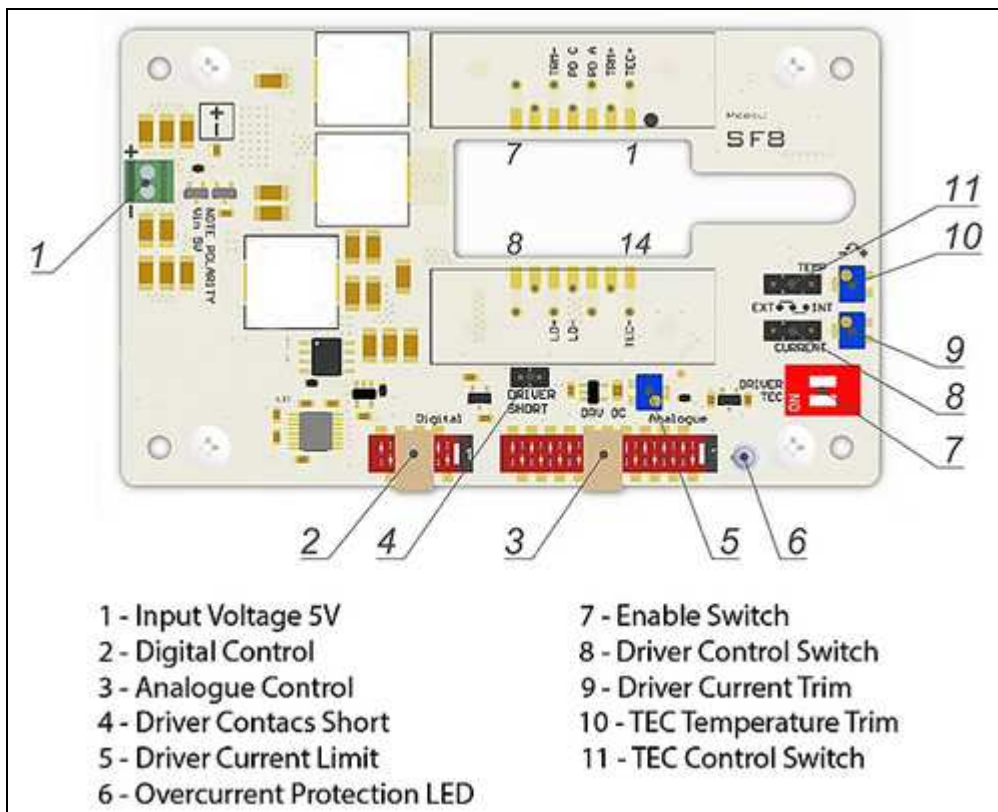

3. STSF8XXX-NM Series Laser Diode Drivers with TEC Controllers

STSF8XXX-NM is modification our STSF8XXX series without mount. It have TEC and LD current channel. STSF8XXX-NM drivers series have special design for supply laser. Driver include high stability current source (0,01mA) for laser diode and TEC for precision maintaining the temperature on peiltier element (TEM) (0,01 °C). The main fields of application is laser pumping, laser spectroscopy, laboratory test set-ups. These devices are an excellent choice for laser diode from Il-VI Laser Enterprise, Eblana Photonics, 3SP Technologies, Furukawa and etc.

Features

- All-in-one current source, temperature controller
- LD low current ripple: $\leq 10\mu\text{A}$
- Current stability $< 0.1\%$



- Integrated PID controller, doesn't require setup
- Soft-start current ramp, current limit, temperature limit for laser diode protection

CURRENT, VOLTAGE & TEC CONTROLLER

- Maximum current LD (I): 250 mA; 750 mA; 1500 mA
- Output voltage LD (V): 0.5-3 V
- Current stability: 0.1 %
- Current set accuracy: < +/- 1 %
- Output current noise: 10-15 μ A
- TEC output current: \pm 4A
- TEC output voltage: \pm 4V
- TEC output current ripple: 2 ~ 4mA
- TEC Feedback Sensor: 10 kOhm NTC
- Temperature Control Range: +15 to +40 $^{\circ}$ C

LASER DIODE PROTECTION

- Soft-Start Current Ramp
- Current limit
- Temperature limit
- Reverse current protection
- ESD and transient protection

DIMENSIONS AND WEIGHT

- Dimensions: 57.9 x 61 x 22 mm
- Weight: 115 g

USER INTERFACE

- Trim potentiometers for driver current and TEC power
- Analog
- RS-232 / UART/ USB

INPUT

- Input Voltage Supply (V_{in}): 5 VDC

PACKAGE SET

- Driver – 1 pcs
- 50 cm ribbon cable with one 8-pin connector – 1 pcs
- 50 cm ribbon cable with one 20-pin connector – 1 pcs
- Datasheet & User Manual – 1 pcs
- USB-UART converter – 1 pcs
- Free software

WARRANTY PERIOD

- One year manufacturer's warranty

4. Benchtop Laser Diode/TEC Controller STMBL1500A

STMBL1500A controller series have special design for supply laser diode in butterfly package in both Type 1 and Type 2 14-pin laser diodes. Controller include high stability current source (0.01mA) for laser diode, TEC for precision maintaining the temperature on peiltier element (TEM) (0.01 $^{\circ}$ C) and Mount with Azimuth ZIF socket for butterfly LD. These controllers are an excellent choice for laboratory test set-ups and has all the necessary protections for safe operation with laser diodes. These devices are an excellent choice for laser diode from II-VI Laser Enterprise, Eblana Photonics, 3SP Technologies, Furukawa, Lumentum inc and etc.

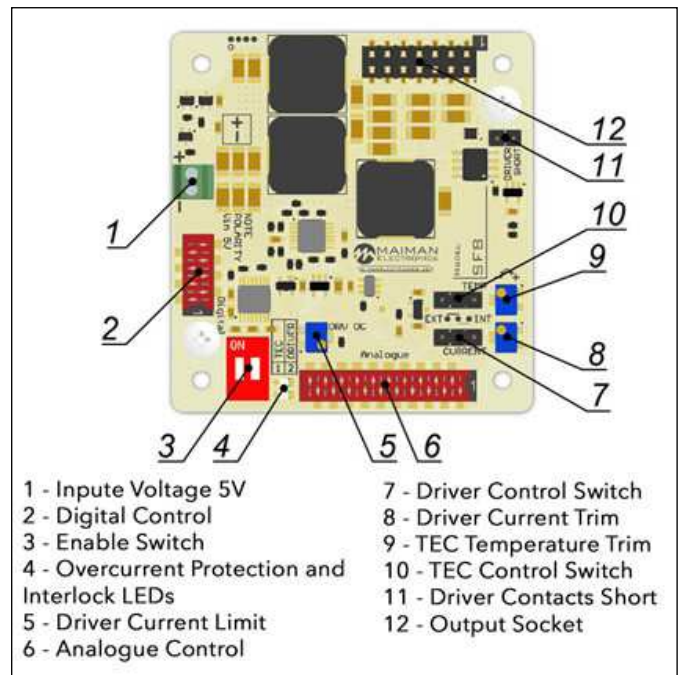



Features:

- All-in-one current source, temperature controller and mount with Azimuth ZIF socket for butterfly LD
- Compatible with Type 1 and Type 2 butterfly 14-pin laser diode
- Controlled locally with touch screen or buttons
- Controlled remote over USB (software and communication protocol included)
- Integrated PID controller, doesn't require setup
- Soft-start current ramp, current protection, temperature protection for laser diode
- Option to save 9 presetting
- Current stability < 0.1%
- Ability to set limits
- Free software

CURRENT, VOLTAGE & TEC CONTROLLER

- Output current LD (I): 1500 mA
- Output voltage LD (V): 0.5-3 V
- Setpoint Resolution: 0,1mA
- Rise Time: <4000 μ s
- Fall Time: <8000 μ s
- Current stability: 0.1 %
- Current set accuracy: < +/- 1 %
- Output current noise: 10-15 μ A
- TEC output power: \pm 4A
- TEC output voltage: \pm 4V
- TEC output current ripple: 2 ~ 4mA
- TEC Feedback Sensor: 10 kOhm NTC
- Temperature Control Range: +15 to +40 °C
- Air Cooling

Laser Diode Protection

- Soft-Start Current Ramp
- Current Protection
- Temperature Protection
- Reverse current protection
- ESD and transient protection

PINOUT

- STSF8XXX support laser diode Type 1: pump laser diode

- STSF8XXXT support laser diode Type 2: telecom laser diode

DIMENSIONS AND WEIGHT

- Dimensions: 257 x 271 x 116 mm
- Weight: 3.4 kg

USER INTERFACE

- Front panel (touch screen or buttons)
- USB

INPUT

- Single phase 220 VAC, 50Hz

5. Benchtop Laser Diode/TEC Controller STMBL1500B

STMBL1500B controller series have special design for supply laser diode. Controller include high stability current source (0,01mA) for laser diode, TEC for precision maintaining the temperature on peiltier element (TEM) (0,01 °C). These controllers are an excellent choice for laboratory test set-ups and has all the necessary protections for safe operation with laser diodes. These devices are an excellent choice for laser diode from II-VI Laser Enterprise, Eblana Photonics, 3SP Technologies, Furukawa, Lumentum inc and etc.

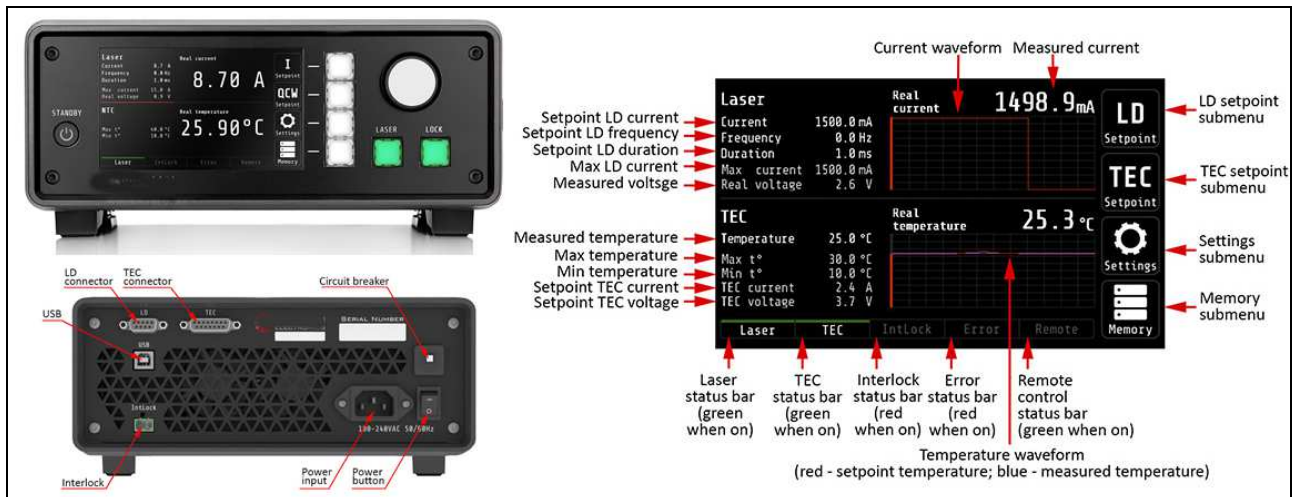

Features

- All-in-One Current Source, Temperature Controller
- Controlled locally with Touch Screen or Buttons
- Controlled remote over USB (Software and Communication Protocol included)
- Integrated PID controller, doesn't require setup
- Soft-Start Current Ramp, Current Protection, Temperature Protection for Laser Diode
- Option to save 9 presetting
- Current stability < 0.1%
- Ability to set Limits
- Free software

CURRENT, VOLTAGE & TEC CONTROLLER

- Output current LD (I): 1500 mA
- Output voltage LD (V): 0.5-3 V
- Setpoint Resolution: 0,1mA
- Rise Time: <4000 μs
- Fall Time: <8000 μs
- Current stability: 0.1 %
- Current set accuracy: < +/- 1 %
- Output current noise: 10-15 μA
- TEC output current: ±4A
- TEC output voltage: ±4V

- TEC output current ripple: 2 ~ 4mA
- TEC Feedback Sensor: 10 kOhm NTC
- Temperature Control Range: +15 to +40 °C
- Air Cooling

Laser Diode Protection

- Soft-Start Current Ramp
- Current Protection
- Temperature Protection
- Reverse current protection
- ESD and transient protection

DIMENSIONS AND WEIGHT

- Dimensions: 257 x 271 x 116 mm
- Weight: 3.3 kg

USER INTERFACE

- Front Panel (Touch Screen or Buttons)
- USB

INPUT

- Single Phase 220 VAC, 50Hz

PACKAGE SET

- Laser diode power supply – 1 pcs
- Power cord – 1 pcs
- USB cable – 1 pcs
- Interlock connector – 1 pcs
- Datasheet & User Manual – 1 pcs

WARRANTY PERIOD

- year manufacturer's warranty

6. Benchtop Laser Controller STG-EM595

The STG-EM595 combines a laser driver and TEC controller into a compact, benchtop device with straightforward user interface. With 1.5A of drive current available, the controller can operate any STG series 14-pin DFB lasers or single mode lasers. The 3.0A of current available for the thermo-electric cooler provides ample control for typical room temperature environments. Precise temperature control results in accurate frequency control. The STEM595 establishes a new level of low noise and linewidth performance in a benchtop device..

Features:

- Easy-to-use control of 14-pin butterfly lasers
- Touch panel interface
- USB interface
- 0.01°C temperature precision
- 1.5A of drive current, 3.0A of TEC current available
- Compact size
- Constant current operation
- Constant power operation



Sample Front Panel Interface Pictures



General Specifications:

USB 2.0 Interface	Compliant with USBTMC/USBTMC-USB488 Specification Rev. 1.0
Interface Protocol	SCPI-Compliant Command Set
Supplied Drivers	VISA VXI pnp™, MS Visual Studio™, MS Visual Studio.net™, LabVIEW™, LabWindows/CVI™
Safety Features	Interlock, Keylock Switch, Laser Current Limit, Soft Start, Short Circuit when Laser Off, Laser Overvoltage Protection, Over Temperature Protection, Temperature Window Protection
Display	4.3" LCD TFT, 480 x 272 Pixels
Socket for Laser, Photodiode, NTC, TEC	Compatible with Butterfly Type 1 (Pump) and Butterfly Type 2 (Telecom)
Connector for Modulation Input	SMA
Connector for Interlock & Laser On Signal	2.5 mm Mono Phono Jack
Connector for USB Interface	USB Type Mini-B
Chassis Ground Connector	4 mm Banana Jack
Desktop Power Supply, Line Voltage, Line Frequency	100 to 240 V ±10%, 47 to 63 Hz
Maximum Power Consumption	40 W
Operating Temperature	0 to +40 °C
Storage Temperature	-40 to +70 °C
Warm-up Time for Rated Accuracy	30 min
Weight	1.0 kg
Dimensions without Operating Elements (WxHxD)	111 mm x 73.5 mm x 152.6 mm (4.37" x 2.9" x 6.01")
Dimensions with Operating Elements (WxHxD)	111 mm x 73.5 mm x 169.2 mm (4.37" x 2.9" x 6.66")

Laser Diode Control Specifications

Laser Diode Control Specifications		
Current Control (Constant Current Mode)		
Control Range	0 to 1.5 A	
Compliance Voltage	>4 V	
Resolution	100 μ A (Front Panel), 50 μ m (Remote Control)	
Accuracy	±(0.1% + 500 μ A)	
Noise and Ripple (typ)	10 μ A without Noise Reduction Filter 5 μ A with Noise Reduction Filter (10 Hz to 10 MHz, RMS) @ 3.3 Ω Load, Current <1.2 A	
Drift (24 hours)	<50 μ A @ 0 - 10 Hz in Constant Ambient Temperature	
Temperature Coefficient	<50 ppm/°C	
Current Limit		
Setting Range	1 mA to 1.5 A	
Resolution	100 μ A (Front Panel), 50 μ m (Remote Control)	
Accuracy	±(0.12% + 800 μ A)	
Photodiode Input	Low Setting	High Setting
Photocurrent Range	2 mA	20 mA
Photo Current Resolution (Via Front Panel)	100 nA	1 μ A

Photo Current Resolution (Via Remote Control)	70 nA	700 nA
Photo Current Accuracy	$\pm(0.08\% + 0.5 \mu\text{A})$	$\pm(0.08\% + 5 \mu\text{A})$
Photodiode Reverse Bias Voltage	0.1 to 6V	
Photodiode Input Impedance	~0 (Virtual Ground)	
Power Control (Constant Power Mode)	Low Setting	High Setting
Photo Current Control Ranges	0 to 2mA	0 to 20mA
Laser Voltage Measurement		
Resolution	1mV (Front panel), 200 V (via Remote Control)	
Accuracy	$\pm(0.1\% + 40 \text{ mV})$	
Laser Overvoltage Protection		
Trip Voltage (typ)	4.2 V	
Modulation Input		
Input Impedance	10 k Ω	
3dB Bandwidth (Constant Current Mode)	DC to 7.5 kHz (with Noise Filter)	DC to 250 kHz (without Noise Filter)
Modulation Coefficient (Constant Current Mode)	150 mA/V $\pm 5\%$	
Modulation Coefficient (Constant Power Mode)	200 $\mu\text{A/V}$ $\pm 5\%$ (PD Low range)	2 mA/V $\pm 5\%$ (PD High Range)

Temperature Control Specifications

TEC Current Output

Control Range: -3.0 to +3.0 A
 Compliance Voltage: >4.7 V
 Max Output Power: >14.1 W
 Resolution: 1mA (Front Panel); 100 m (Remote Control)
 Accuracy: $\pm(0.2\% + 20 \text{ mA})$

TEC Current Limit

Setting Range: 5 mA to 3.0 A
 Resolution: 1mA (Front Panel); 100 m (Remote Control)
 Accuracy: $\pm(0.2\% + 20 \text{ mA})$

NTC Thermistor Sensors

Resistance Measurement Range: 300 Ω to 150 k Ω
 Control Range: -55 $^{\circ}\text{C}$ to +150 $^{\circ}\text{C}$ (Max)
 Temperature Resolution: 0.01 $^{\circ}\text{C}$
 Resistance Resolution: 1 Ω
 Accuracy: $\pm(0.1\% + 1 \Omega)$
 Temp Stability (24 hours): <0.005 $^{\circ}\text{C}$ (Typ.)
 Temperature Coefficient: <5 mK/ $^{\circ}\text{C}$

Temperature Window Protection

Setting Range: 0.01 $^{\circ}\text{C}$ to 100.0 $^{\circ}\text{C}$
 Protection Reset Delay: 0 to 600 s

7. Laser diode power supply STM-MBH1510, STM-MBH3010, STM-MBH1240

The STM-MBHXXXX is series of precision high power laser diode controllers. It is optimized for driving laser diodes or high power LED arrays with an output current range up to 250A, output voltage range up to 40V. Multiple built-in protection features ensures safety work. Digital control is provided via an USB 2.0 interface. Free software is included in the delivery set.



STM-MBH1510

PARAMETER	TEST CONDITIONS	MIN	TYP	MAX	UNIT
Output voltage		1		10	V
Output current		0		15	A
Current ripple			12	15	mA
Current set step			0.01		A
Current set accuracy	2A < I _{out} < 5A		± 5		%
Current set accuracy	5A < I _{out} < 15A		± 1		%

STM-MBH3010

PARAMETER	TEST CONDITIONS	MIN	TYP	MAX	UNIT
Output voltage		1		10	V
Output current		0		30	A
Current ripple			12	15	mA
Current set step			0.01		A
Current set accuracy	5A < I _{out} < 10A		± 5		%
Current set accuracy	10A < I _{out} < 30A		± 1		%

STM-MBH1240

PARAMETER	TEST CONDITIONS	MIN	TYP	MAX	UNIT
Output voltage		5		40	V
Output current		0		12	A
Current ripple			15	25	mA
Current set step			0.01		A
Current set accuracy	2A < I _{out} < 5A		± 5		%
Current set accuracy	5A < I _{out} < 15A		± 1		%
Current set accuracy					

The power supply includes various protections that prevent damage to the LD.

External interlock:

- External interlock function provides multiply protections at the same time:
 - Prevents inadvertent use;
 - Allows to connect an external emergency switch;
 - Allows to connect an external auto protect device (e.g. over-temperature switches).
 - The laser can only be turned on with shorted Interlock.
- **Soft-start:** The soft-start function protects against unwanted overshoot of the LD in the power up process.
- **LD max current limiting:** You cannot set the operating current above LD max current.
- **Over-temperature protection:** The STM-MBHxxxx has automatic overheating protection. If the set external NTC max temperature is exceeded, the LD power supply will be automatically turned off. After the temperature returns to normal, the LD power supply can be switched on again.
- **State after switching on:** After turning on the STM-MBHxxxx with the Standby button the LD power supply and TEC will always be turned off.
- **Memorization of parameters:** In case of an interruption/unplanned shutdown, the STM-MBHxxxx remembers the settings that were set at the time of the last On/Off Laser command.

- **Dimensions:** 257 x 271 x 117 mm
- **Weight:** 3.6 kg
- **User interface:** Front Panel (Touch Screen or Buttons) and USB
- **Input:** Single Phase 100-240 VAC, 50Hz

LDDY Series Diode Drivers with TEC Controllers

LDDY series diode laser drivers with TEC controllers are designed to drive diode lasers. They can drive maximum 2 diodes and 4 TE coolers. Of them 2 TE coolers are used to cool diode lasers and 2 TE coolers are used to cool SHG crystal and THG crystal. The drivers are made in modules and thus the customer can select the modules (outputs of the drivers) according to his needs with lower cost and smaller size.

Our diode drivers are contact and reliable. They are ideal power supplies to drive diode lasers, fiber lasers and DPSS lasers.



Features:

- Suitable to use for 1064nm, 532nm and 355nm lasers
- Suitable to drive DILAS/COHERENT diode lasers with high current at maximum 5V 60A output
- Suitable to drive NLIGHT/BWT diode lasers with high voltage at maximum 32V 15A output
- Air-cooled or default water-cooled
- Maximum 4-channel outputs for TE cooler to cool diode lasers and crystals
- Output parameters adjustable
- Outputs such as laser current, GATE & pulse repetition rate available, internal or external control selectable
- INTERLOCK, ready & alarm signals available
- Can be controlled by RS232, pressing button or marking software

Applications:

- DPSS lasers
- Fiber lasers
- Diode lasers
- Current-constant sources

Technical Specifications:

4-channel TEC controls	Use NTC with temperature stability of ± 0.01 °C 2-direction control (cooling or heating)	
	Temp1	2-direction 12V/10A output with accuracy ± 0.01 °C, used to drive diode laser
	Temp2	2-direction 12V/10A output with accuracy ± 0.01 °C, used to drive the 2 nd diode laser or to control laser crystal's temperature if there is no water cooling in the system
	Temp3	2-direction 5V/3A output with accuracy ± 0.01 °C, used to control crystal's temperature
Temp4	2-direction 5V/3A output with accuracy ± 0.01 °C, used to control crystal's temperature	
LD drivers	2-channel outputs each with max. 5V & 0-60 Adjustable, or output with max. 32V & 0-16A adjustable to drive diodes. Efficiency>85%, current ripple<10mA, voltage ripple<15mV. Voltage fixed, over current and over voltage protection. Lower voltage protection. Support external enable control and current control.	

AOM/Q-switch control	Internal PWM with frequency 1000Hz-300000Hz, step 1000Hz. Pulse width 100ns - 30us adjustable. Internal/external control selectable. Temperature alarm.
Option	AOM/Q-switch driver (41MHz, 80MHz), RS232 control

Part model	LDDY1015	LDDY1515	LDDY2415	LDDY2815	LDDY3215
Input voltage (VAC)	220±15%	220±15%	220±15%	220±15%	220±15%
No. of TEC control	1-4	1-4	1-4	1-4	1-4
Temperature accuracy	±0.01 °C				
Temperature control range	5 °C-50 °C				
Temperature sensor	NTC (10K@25 °C)				
First output to LD	15A/10V	15A/15V	15A/24V	15A/28V	15A/32V
Second output to LD	15A/10V	15A/15V	15A/24V	15A/28V	15A/32V
PWM frequency	1-500kHz	1-500kHz	1-500kHz	1-500kHz	1-500kHz
Dimension	W×L×H = 483×308×88mm				
Weight	2kg				

Remark: the above products are suitable to drive NLIGHT/BWT diode lasers with high voltage at maximum 32V 15A output

Part model	LDDY0515	LDDY0530	LDDY0540	LDDY0550	LDDY0560
Input voltage (VAC)	220±15%	220±15%	220±15%	220±15%	220±15%
No. of TEC control	1-4	1-4	1-4	1-4	1-4
Temperature accuracy	±0.01 °C				
Temperature control range	5 °C~50 °C				
Temperature sensor	NTC (10K@25 °C)				
First output to LD	15A/5V	30A/5V	40A/5V	50A/5V	60A/5V
Second output to LD	15A/5V	30A/5V	40A/5V	50A/5V	60A/5V
PWM frequency	1-500kHz	1-500kHz	1-500kHz	1-500kHz	1-500kHz
Dimension	W×L×H = 483×308×88mm				
Weight	2kg				

Remark: Suitable to drive DILAS/COHERENT diode lasers with high current at maximum 5V 60A output

Suggestions:

- For DPSS lasers, please select the numbers of diode driving and TEC cooling according to the used numbers in the lasers.
- For high-power 1064nm DPSS lasers, no need to use TEC controls since there is water cooling in the laser system. The diode laser and laser crystal will be cooled via heat conduction of the base which is water-cooled. For 532nm DPSS lasers, only TEMP3 is needed. For 355nm DPSS lasers, TEMP3 and TEMP4 are needed.
- Default outputs are 1set diode laser driver. Others are options.
- In general, water cooling is better than air cooling for DPSS lasers. If there is no water cooling in the system, TEM2 is often used to cool the laser crystal.

LDD Series Laser Diode Drivers without TEC



The laser diode driver LDD-AAVV is a high current-constant laser diode driver without thermo-electric cooler controller. Current control, transient suppression, over-temperature protection, short circuit protection, and over current limit are provided. 2 digital meters show the output current and output voltage. The driver is mainly used to drive diode modules.

Specifications:

Model: LDD-AAVV

LDD-laser diode driver

AA-maximum output current (A). The output current is continuously adjustable.

VV-maximum output voltage (V). The output voltage is determined by current & diode's resistance.

Input voltage: 220VAC, +/-15%

Voltage noise: <0.1% p-p

Current noise: <=50mA

Un-stability: <0.1%

Dimension: 482×88x260mm

Net weight: 6.5kg

Remark:

To select a driver, you may finalise the output voltage first and then finalise maximum output power.

The maximum output current will be the maximum power divided by the output voltage.

Typical Diode Drivers:

Part Number	LDD3012	LDD3024	LDD6024	LDD6060	LDD30120	LDD60120
Output Current	0-30A	0-30A	0-60A	0-60A	0-30A	0-60A
Output Voltage	0-12V	0-24V	0-24V	0-60V	0-120V	0-120V
Input Voltage	220V AC	220V AC	220V AC	380V AC	220V AC	220V AC

STO Series OEM Laser Diode Drivers

1. STO-LDD Series CW Diode Drivers

STO is a series of laser diode drivers intended for single laser diode driving as well as for laser diode arrays driving. Maximal output power ranges from 50W to 1500W, and maximal output current ranges from 5A to 100A. These drivers may be used for industrial and medical applications.



Part number: STO-LDD-xx-AA

STO-LDD: STO-LDD series OEM diode drivers
 xx : Maximum output power
 AA: maximum output current

The maximum output voltage is maximum output power divided by output current. Current is adjustable in range 10-100% of I_{max} . I_{max} is selected by customer. V_{max} is calculated as $V_{max} = \text{Power} / I_{max}$. Voltage is adjusted automatically in dependence on load, but voltage cannot exceed V_{max} .

PART NAME	MAX POWER	CURRENT	INPUT VOLTAGE	Dimension mm	Weight kg	CASE
STO-LDD-150-AA	150 W	5-75 A	110/230 VAC	225x181x68	1.8	B
STO-LDD -250-AA	250 W	10-100 A	110/230 VAC	225x181x68	1.8	B
STO-LDD -400-AA	400 W	10-100 A	230 VAC	225x181x68	1.8	B
STO-LDD -600-AA	600 W	10-100 A	110/230 VAC	296x213x70	2.9	C
STO-LDD -1000-AA	1000 W	10-100 A	110/230 VAC	296x213x70	2.9	C
STO-LDD -1500-AA	1500 W	10-100 A	230 VAC	296x213x70	2.9	C

Specifications:

OUTPUT	
Efficiency	more than 80%
Rise/fall time	< 1 ms (10% to 90% full current) < 500 us on request
Current regulation accuracy	< 1% of I_{MAX}
Current value error	< 1% of I_{MAX}
Current overshoot	< 1% of I_{MAX}
INTERFACE	
Connector	15 Pin "D"-Sub Female
Current program	analog, 0-10 V
Current monitor	analog, 0-10 V

Voltage monitor	analog, 0-10 V
SAFETY	
PFC value	> 0.98 (active)
Leakage current	< 150 μ A
Input/output isolation voltage	4000 VAC
Safety approval	IEC60950, IEC60601-1
EMC approval	EN55011 (Class A)
Cooling	No external cooling is required
ENVIRONMENT	
Operation temperature	0 ... +40 °C
Storage temperature	-20 ... +60 °C
Humidity	90%, non-condensing

Interface

PIN (color)	DESIGNATION	DESCRIPTION
1 (green)	Enable	Apply +5V DC on this pin to enable work of LDD. While 0V are applied to this pin or pin is unconnected module is disabled. Once <i>Fault</i> has occurred module is blocked till you eliminate fault cause, then <i>disable</i> module and <i>enable</i> it again.
2 (orange)	Fault *	If module is <i>enabled</i> and some trouble has occurred, module automatically stops operations and sets <i>Fault</i> status (<i>Fault</i> loop is "closed"). In case of normal operations <i>Fault</i> loop is "opened". Maximal allowed current in <i>Fault</i> loop is 50mA.
3 (transparent)	Interlock	When <i>Interlock</i> loop is "opened" output is inhibited. You should "close" this loop to start operations (electrical resistance of "closed" loop should be below 100 Ohm level). Once <i>Interlock</i> has occurred module is blocked till you "close" <i>Interlock</i> loop, then <i>disable</i> module and <i>enable</i> it again.
4, 9, 15 (black)	Interface Return	Return of all interface circuits. This pin is connected to the GROUND stud.
5 (yellow)	V OUT monitor	The voltage at this pin is a monitor signal proportional to the measured value of voltage on load. 0V at <i>PIN5</i> corresponds to 0V at load. Voltage at <i>PIN5</i> corresponds either to voltage at load ($V_{MAX} < 10V$) or to one-half of this voltage ($V_{MAX} > 10V$).
6 (purple)	I OUT monitor	The voltage at this pin is a monitor signal proportional to the measured value of output current. 0V at <i>PIN6</i> corresponds to 0A. 10V at <i>PIN6</i> corresponds to I_{MAX} .
7 (blue)	I program	Voltage applied to this pin sets output current. 0-10V DC are linear with 0- I_{MAX} .
8 (white)	Pulse	Apply +5V DC on this pin to allow the output. While 0V are applied to this pin or pin is unconnected output is inhibited.
10-12	–	Not used
13, 14 (red)	+15V OUT	Auxiliary 15 VDC output. Maximal current – 100mA.

Fault

Module sets Fault state in the following cases:

- overheating (temperature of the module exceeds 70+/-2 °C level).
To remove Fault status module must be cooled below 65+/-1 °C temperature.
- overvoltage (voltage on the load exceeds 110% of V_{MAX} level).
Most popular causes of such fault are load type mismatch and load absence.
- overcurrent (output current exceeds 1.05 I_{MAX} level)
- incorrect I Program (input voltage exceeds 10.5V level)
Once Fault has occurred you should eliminate Fault cause, then "reboot" module (DISABLE module and ENABLE it again).

2. STO-PDD Series Pulse Diode Drivers



STO-PDD series diode drivers are probably the most powerful diode drivers in the aesthetic world. Peak output power is up to 10kW (with user selectable I_{MAX} and V_{MAX}). Averaged output power is up to 1600W (assuming 100-240VAC input) and over 2000W on request (with 200-240VAC input).

Since the driver was especially designed for laser hair removal applications, it's fully compliant to the medical standards - IEC 60601-1 for electrical safety and IEC 60601-1-2 for electromagnetic compatibility. Besides, they are also widely used in diode pumping and direct diode laser applications.

Part no.		STO-PDD-300	STO-PDD-1000	STO-PDD-1600
Input	Power Input	100-240VAC, 50/60Hz	300VDC + 24VDC/1A	100-240VAC, 50/60Hz
Output	Max. average power	300W	100W	1600W
	Max. current, I _{max}	200A	200A	200A
	Max. voltage, V _{max}	50V	200V	100V
	Max. peak power, W _{max}	5kW	10kW	10kW
	Rise/fall time	<1ms (10% to 90% full current)	<1ms (10% to 90% full current)	<1ms (10% to 90% full current)
	Current regulation accuracy	<1% of I _{max}	<1% of I _{max}	<1% of I _{max}
	Current value error	<1% of I _{max}	<1% of I _{max}	<1% of I _{max}
	Current overshoot	<1% of I _{max}	<1% of I _{max}	<1% of I _{max}
	Efficiency	>80%	>80%	>80%
Environment	Operating temp.	0-+40°C	0-+40°C	0-+40°C
	Storage temp.	-20-+60 °C	-20-+60 °C	-20-+60 °C
	Humidity	90%, non-condensing	90%, non-condensing	90%, non-condensing
Interface	Connector	15Pin D-sub female	10 pin Molex C-Grid connector	15Pin D-sub female
	Current program	Analog, 0-10V	Analog, 0-10V	Analog, 0-10V
Others	Size (LxWxH)	296x213x70mm	255x172x82mm	230x223x133mm
	Weight	2.8kg	2.2kg	5kg

3. STO-PDD-3U Pulsed Diode Driver

STO-PDD-3U is a pulsed diode driver especially designed for diode pumping of Nd:YAG and similar solid-state lasers. It is quite a high power solution. Maximal output power is up to 500W. Maximal output current (I_{MAX}) and maximal compliance voltage (V_{MAX}) achieve 400A and 400V respectively although not at the same time (with peak power limited with 20kW). A number of models with different I_{MAX} and V_{MAX} is available.

APPLICATIONS

Pumping of pulsed DPSS lasers (Nd:YAG, diodes and similar)

FEATURES

- 100-240VAC input
- Output current up to 400A
- Output voltage up to 400V
- Output power up to 20kW (peak)
- Output power up to 500W (average)
- Fast rise and fall times
- Multiple outputs and other options



INTERFACES

User interface is 7-inch full color display on front panel. Base machine interface is RS-485. The following user and machine interfaces are available as alternatives:

- RS-232 machine interface
- Remote control (see picture below)
- No front panel UI (low cost modification for embedded applications)

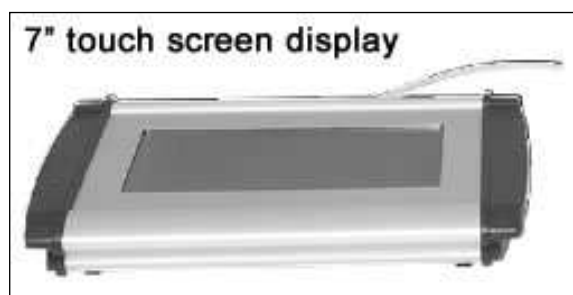

WATER COOLING (OPTION)

STO-PDD-3U can be supplied in two modifications different with cooling method. The default option is a forced air cooling with embedded fans. Since, due to high heat dissipation at maximal output power, the noise produced by fans might seem to be undesirable high, we offer an alternative of water cooling.

Input	
Voltage	100-240VAC, 50/60Hz
Current	10A max
Laser diode output	
Regime of operations	Pulsed
Maximal output current (IMAX)	200A (in base modification, other on request)
Maximal output voltage (VMAX)	100V (in base modification, other on request)
Maximal output power (peak, IMAX * VMAX)	20kW
Risetime/falltime	10us-40us (load and output current dependent)
Pulse width (t)	50us-300us (in base modification, other on request)
Pulse repetition rate (f)	1Hz-100Hz (in base modification, other on request)
Maximal output power (average, IMAX * VMAX * f * t)	500W
Current overshoot	<5% of IMAX
Current accuracy/stability	<1% of IMAX
Protections	Protective crowbar at the output; From overcurrent, adjustable current limit; From overvoltage From too long pulses; From too high repetition rate; From too high average power; Interlock; From overheating
Options	
User interfaces (UI)	7" color display with touch panel or no display / Remote control
Machine interfaces	RS-485 or RS-232
Multiple outputs	+
Embedded TECs	+
Pockels cell driver control	+
Cooling methods	Forced air cooling with embedded fans (relatively noisy at high output power) / Water cooling (more silent)
Low cost option	+ (difference in simpler coverage only)
Environmental	

Operating temperature	+15...+35, non-condensing
Storage temperature	-20...+60C
Mechanical	
Dimensions	19-inch rack, 3U height, approx. 40cm depth
Weight	Up to 10kg (modification dependent)

Most of the parameters can be tailored to the customer's requirements. Feel free to contact us if your needs are different from the specifications above.

TEC Temperature Controllers

1. OEM TEC Temperature Controller

TEC module is designed for regulating the temperature of the objects and the stabilizing its temperature at the certain level. The target temperature is set with an analog input voltage. Voltage output is provided to monitor temperature of the object.

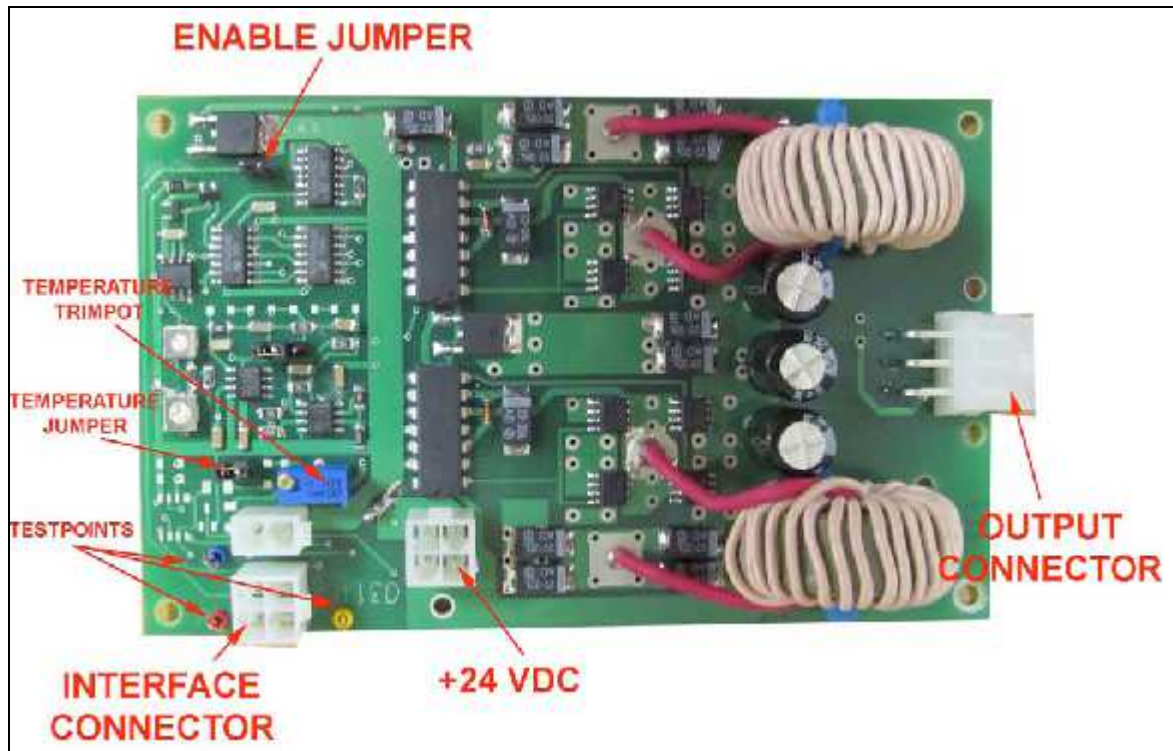

Specifications:

Part number	TEC-OEM2010
Input voltage	+24VDC
Output voltage	-20..+20 V
Output current	up to 10A
Output power	up to 150W
Feedback loop	10kOhm NTC thermistor
Output temperature range	10..40 °C (other on request)
Temperature accuracy	0.1 °C
Cooling	forced air cooling is needed at >7A operations
Dimensions	130x80x30mm
Weight	300g

Calibration table

This table is valid only if the module is used with 10kOhm NTC supplied

Temperature, °C	Resistance, kOhm	Voltage, V
10.0	19.9	0.075
20.0	12.5	0.975
25.0	10.0	1.55
30.0	8.06	2.21
40.0	5.33	3.83

Electrical interface

+24VDC

Port	PIN (color)	DESIGNATION	DESCRIPTION
------	-------------	-------------	-------------

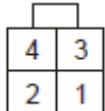
	1, 2 (red)	+24VDC	+24VDC; power supply positive
	3, 4 (black)	RETURN	+24VDC; power supply return

Control interface

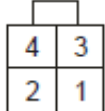
Port	PIN (color)	DESIGNATION	DESCRIPTION
	1 (violet)	TPROGRAM	Temperature program voltage (sets the desired load temperature; 0-4V corresponds to 10-40°C; see also Calibration table section)
	2 (white)	TMONITOR	Temperature monitor (measures the real load temperature; 0-4V corresponds to 10-40°C; see also Calibration table section)
	3 (green)	ENABLE	Turns TEC on (+5VDC applied to this pin enables the output; 0V or unconnected pin lead to no actions)
	4 (black)	RETURN	Return of all INTERFACE signals

OUTPUT

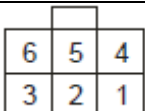
Port	PIN (color)	DESIGNATION	DESCRIPTION
	1,2 (red)	TEC +	Peltier positive
	3,4 (blue)	NTC	NTC thermistor connections
	5,6 (black)	TEC -	Peltier negative

ENABLE JUMPER – in the case of stand-alone operations can be used instead of ENABLE signal of INTERFACE connector;

Please do not use ENABLE JUMPER and ENABLE signal at the same time

TEMPERATURE JUMPER – if this jumper is set on TEMPERATURE

TRIMPOT can be used instead of TPROGRAM signal of INTERFACE connector;

Please do not use TEMPERATURE JUMPER and TPROGRAM signal at the same time

TEMPERATURE TRIMPOT – sets output temperature in the case of stand-alone operations (i.e. when TEMPERATURE JUMPER is set on);

Clockwise rotation increases temperature set point

TESTPOINTS:

red – temperature set point voltage

blue – ground (return)

yellow – temperature monitor voltage

2. Bench-top TEC Controller



Assembled in standard bench-top plastic case, our TEC-BT2010 temperature controller demonstrates

high output power along with high temperature control precision.

- Maximal output current up to 10 A
- Maximal output voltage up to 20 V
- 0.1C precision
- Improved parameters on request
- RS-232 interface

Part number	TEC-BT2010
Input voltage	110/230VAC, 50/60Hz, 2.0A max.
Output voltage	-20..+20 V
Output current	up to 10A
Output power	up to 150W
Feedback loop	10kOhm NTC thermistor
Output temperature range	10..40 °C (other on request)
Temperature accuracy	0.1 °C
Cooling	forced air cooling with the embedded fan
Dimensions	225x200x60mm
Weight	1.5kg