

## STK Series Fiber Coupled Laser Diodes

### 1. STK Series Fiber Coupled Laser Diodes

Our STK series fiber-coupled laser diodes can be divided into two categories: single emitter laser diodes and multi-single emitter laser diodes.

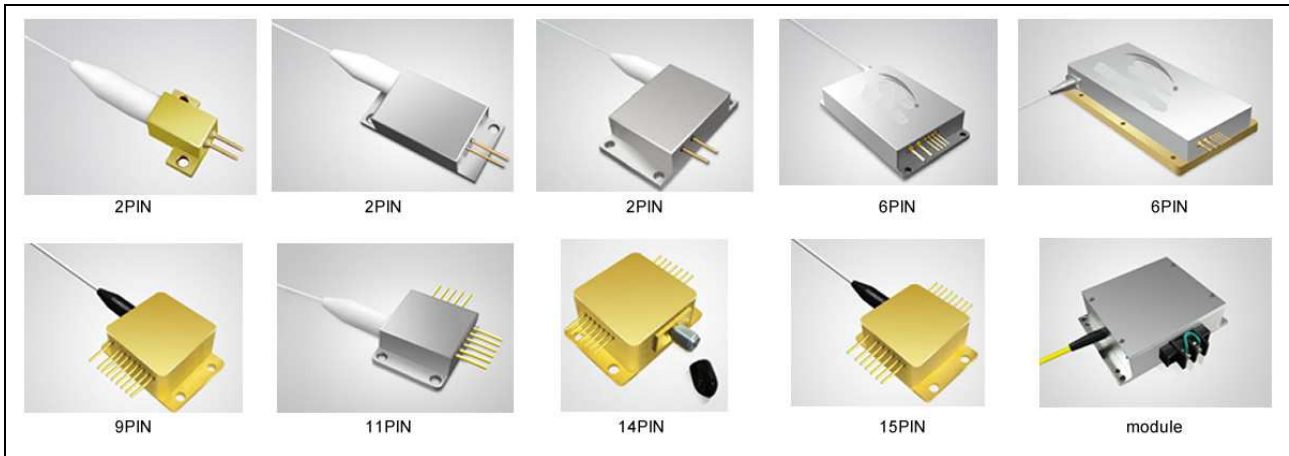

#### 1.1 Single Emitter Laser Diodes

Single emitter laser diodes can provide multi-wavelength covering 405nm to 976nm, output power from 2mW to 10W. Mainly used in the area of fiber laser pumping, computer to plate (CTP), DPSS laser pumping, medical use, aiming beam, industry etc. For different application, varieties of packages with optional functions of aiming beam, photo detector, TEC, fiber detector, thermistor and other functions are available.

#### 1.2 Multi-single Emitter Laser Diodes

Multiple single emitter laser diodes build upon the foundation of multi-emitter coupling technology, to obtain high power and high brightness diode laser. Varieties of packages with optional functions of aiming beam, photo detector, TEC, fiber detector, thermistor and other functions are available. Multi single emitter laser diodes have great advantages in high reliability and high performance. In multi-single emitter laser diodes, we have patented many improved optical designs. And these compact packages and commercially recognized formats allow easy integration into the existing products. Multi single emitter diode lasers include wavelengths from 635nm-1064nm, output power from 1.6W-350W.

405nm	450nm	520nm	635nm	785nm	793nm	808nm	
160mW	800mW 3W 20W 50W 200W	2mW 5mW 10mW	2mW 20mW 400mW 1.8W 5W	600mW	4W 8W 12W 16W 30W 50W 80W 140W 180W	4W 8W 10W 15W 20W 25W 30W 40W 55W 60W 70W 150W	
830nm	878.6nm	888nm	915nm	940nm	976nm	976nm wavelength stabilized	1064nm
600mW 1W 2W	30W 65W 80W 120W 175W	80W 120W	10W 12W 30W 35W 70W 100W 130W	10W 20W 70W 150W 200W 500W	10W 15W 20W 70W 150W 200W 300W	3W 9W 18W 27W 50W 60W 100W	10W 15W 20W

			160W 180W 300W 500W		500W	130W 140W 180W	
--	--	--	------------------------------	--	------	----------------------	--

### 1.3 Multi-wavelength Fiber-coupled Laser Diodes

#### Features:

- Multiple wavelength
- Multiple function
- 200um fiber detachable

#### Applications:

- Medical use

Our High Power Diode Laser Modules are manufactured by adopting specialized fiber-coupling techniques, resulting in volume products with a high efficiency, stability and superior beam quality. The products are achieved by transforming the asymmetric radiation from the laser diode chip into an output fiber with small core diameter by using special micro optics. Inspecting and burn-in procedures in every aspect come to a result to guarantee each product with the reliability, stability and long lifetime.

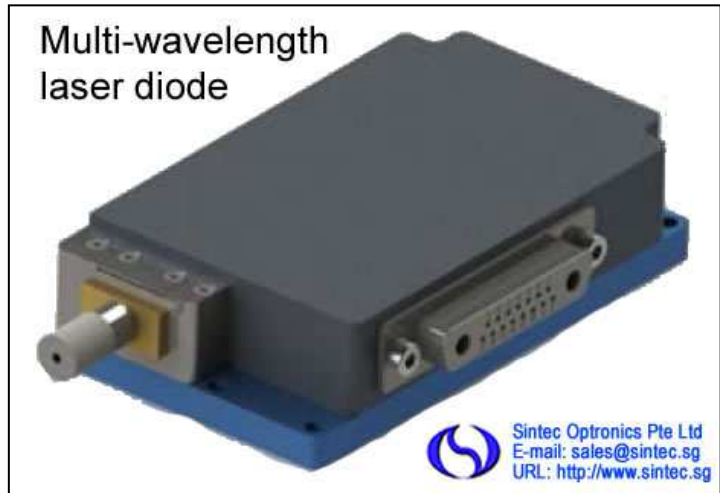

Our research staffs are constantly improving and innovating the processing technology in the producing process, based on the professional knowledge and experience accumulated in long-terms. We are also continuously developing new products to meet customers' specific needs.

To provide high quality products with reasonable price is our always goal.

#### List of Multi-wavelength Laser Diodes

Part number	Wavelength (nm)	Laser power (W)	Fiber (core/NA/connector)
STKA060D100F003G050ML	808/980/450/635nm	6W/10W/5W/0.3W	200µm/0.22/SMA905
STKA250D150F006G050MH	808/980/450/635nm	25W/15W/5W/0.6W	200µm/0.22/SMA905
STKA060D100E060F003ML	808/980/1064/635nm	6W/10W/6W/0.3W	200µm/0.22/SMA905
STKA250D150E100F006MH	808/980/1064/635nm	25W/15W/10W/0.6W	200µm/0.22/SMA905

#### OPERATING NOTES

- Avoid eye and skin exposure to direct radiation during operation.
- ESD precautions must be taken during storage, transportation and operation.
- Short-circuit is required between pins during storage and transportation.
- Please connect pins to wires by solder instead of using socket when operation current is higher than 6A. Soldering point should be close to the root of the pins. Soldering temperature should be lower than 260°C and time shorter than 10 second.
- Make sure the fiber output end is properly cleaned before operation of laser. Follow safety protocols to avoid injury when handling and cutting the fiber.
- Use constant current power supply to avoid surge current during operation.
- Laser diode must be used according to the specifications.
- Laser diode must work with good cooling.
- Operation temperature ranges from 15°C to 35°C.
- Storage temperature ranges from -20°C to +70°C.

### 1.4 List of Fiber-coupled Laser Diodes

Wavelength	Power	Fiber	Package	Type
405nm	160mW	40µm/0.22	Coaxial	
450nm	800mW	105µm/0.22	14 pin Butterfly	
520nm	2mW	4µm/0.13	Coaxial	

520nm	5mW	4µm/0.13	Coaxial	
520nm	10mW	105µm/0.22	Coaxial	
635nm	2mW-20mW	4µm/0.13	Coaxial	Single Emitter, SM
635nm	5mW-50mW	105µm/0.22	Coaxial	Single Emitter, MM
635nm	400mW	105µm/0.22	Coaxial	Single Emitter, MM
635nm	1.8W	105µm/0.22	16 pin	Multi-single Emitter, MM
635nm	5W	105µm/0.22	8pin module	Multi-single Emitter, MM
650nm	2mW	4µm/0.13	Coaxial	Single Emitter, SM
650nm	4mW	105µm/0.22	Coaxial	Single Emitter, MM
660nm	5mW-30mW	4µm/0.13	Coaxial	Single Emitter, MM
660nm	10mW-60mW	105µm/0.22	Coaxial	Single Emitter, MM
785nm	600mW	105µm/0.22	14 pin butterfly	Wavelength stabilized
793nm	4W	105µm/0.22	2 pin	
793nm	8W	105µm/0.22	2 pin module	
793nm	12W	105µm/0.22	2pin module	
793nm	15W	105µm/0.22	4pin module	
793nm	30W	105µm/0.22	6pin module	
793nm	40W	200µm/0.22	2pin module	
793nm	55W	105µm/0.22	6pin module	
793nm	80W	200µm/0.22	6pin module	
793nm	140W	200µm/0.22	2pin	
793nm	180W	200µm/0.22	2pin	
808nm	4W	105µm/ 0.22	6pin	Single Emitter
808nm	4W	105µm/ 0.22	11pin	Single Emitter
808nm	4W	400µm/0.22	11pin (Detachable)	Single Emitter
808nm	7W	200µm/0.22	15pin	Single Emitter
808nm	7W	200µm/0.22	14pin (Detachable)	Single Emitter
808nm	8W	200µm/0.22	15pin	Single Emitter
808nm	8W	200µm/400µm/0.22	14pin (Detachable)	Single Emitter
808nm	13W	200µm/0.22	15pin	Multi-single Emitter
808nm	15W	200µm/0.22	15pin	Multi-single Emitter
808nm	15W-20W	200µm/0.22	4pin	Multi-single Emitter
808nm	30W	400µm/0.22	4pin	Multi-single Emitter
808nm	35W	105µm/0.22	6pin	Multi-single Emitter
808nm	40W	400µm/0.22	6pin	Multi-single Emitter
808nm	50W	400µm/0.22	6pin	Multi-single Emitter
808nm	60W	400µm/0.22	6pin	Multi-single Emitter
808nm	60W	105µm/0.22	6pin	Multi-single Emitter
808nm	100W	200µm/0.22	6pin	Multi-single Emitter
808nm	6W,8W,10W,15W	400µm/0.22	module	Fiber-bundled module
830nm	1W	50µm/0.14	2pin	
830nm	2W	50µm/0.14	2pin	
878.6nm	30W	400µm/0.22		
878.6nm	65W	400µm/0.22		
878.6nm	80W	400µm/0.22		
878.6nm	120W	400µm/0.22		
878.6nm	175W	400µm/0.22		
888nm	80W	400µm/0.22	module	Fiber-bundled module
888nm	120W	400µm/0.22	module	Fiber-bundled module
915nm	11W	105µm/0.22	2pin	Single Emitter
915nm	20W	105µm/0.22	2pin	Multi-single Emitter
915nm	25W	105µm/0.15	2pin	Multi-single Emitter
915nm	30W	105µm/0.22	2pin	Multi-single Emitter
915nm	65W	105µm/0.15	2pin	Multi-single Emitter
915nm	70W	105µm/0.22	6pin	Multi-single Emitter
915nm	110W	105µm/0.15	6pin	Multi-single Emitter
915nm	150W	105µm/0.22	6pin	Multi-single Emitter
915nm	158W	105µm/0.22	6pin	Multi-single Emitter
915nm	200W	200µm/0.22	6pin	Multi-single Emitter
940nm	11W	105µm/0.22	2pin	Multi-single Emitter
940nm	20W	105µm/0.22	2pin	Multi-single Emitter
940nm	25W	105µm/0.15	2pin	Multi-single Emitter
940nm	30W	105µm/0.22	2pin	Multi-single Emitter
940nm	70W	105µm/0.22	6pin	Multi-single Emitter

940nm	200W	200µm/0.22	6pin	Multi-single Emitter
940nm	18W	275µm/0.22	module	Fiber-bundled Modules
965nm	11W	105µm/0.22	2pin	Single emitter
965nm	20W	105µm/0.22	2pin	Multi-single Emitter
965nm	25W	105µm/0.15	2pin	Multi-single Emitter
965nm	30W	105µm/0.22	2pin	Multi-single Emitter
965nm	70W	105µm/0.22	6pin	Multi-single Emitter
965nm	200W	200µm/0.22	6pin	Multi-single Emitter
976nm	4W	105µm/0.22	6 pin	Single emitter
976nm	4W	105µm/0.22	9pin	Single emitter
976nm	4W	200µm/0.22	9 pin (Detachable)	Single emitter
976nm	4W	105µm/0.22	11 pin	Single emitter
976nm	4W	200µm/0.22	11pin (Detachable)	Single emitter
976nm	10W	105µm/0.22	11 pin	Single emitter
976nm	10W	200µm/0.22	11 pin (Detachable)	Single emitter
976nm	10W	105µm/0.22	15 pin	Single emitter
976nm	10W	200µm/0.22	14 pin (Detachable)	Single emitter
976nm	10W	200µm/0.22	AT (Detachable)	Single emitter
976nm	11W	105µm/0.22	2pin	Single emitter
976nm	20W	105µm/0.22	2pin	Multi-single Emitter
976nm	25W	105µm/0.15	2pin	Multi-single Emitter
976nm	30W	105µm/0.22	2pin	Multi-single Emitter
976nm	60W	105µm/0.15	2pin	Multi-single Emitter
976nm	70W	105µm/0.22	6pin	Multi-single Emitter
976nm	200W	200µm/0.22	6pin	Multi-single Emitter
976nm	3W	105µm/0.22	2pin	Wavelength stabilized series
976nm	9W	105µm/0.22	2pin	Wavelength stabilized series
976nm	18W	105µm/0.22	2pin	Wavelength stabilized series
976nm	27W	105µm/0.22	4pin	Wavelength stabilized series
976nm	50W	105µm/0.15	6pin	Wavelength stabilized series
976nm	60W	105µm/0.22	6pin	Wavelength stabilized series
976nm	80W	105µm/0.15	6pin	Wavelength stabilized series
976nm	85W	105µm/0.22	6pin	Wavelength stabilized series
976nm	180W	200µm/0.22	6pin	Wavelength stabilized series
976nm	10W,15W	400µm/0.22	module	Fiber-Bundled Module
976nm	980/808/15W	400µm/0.22	15pin	Double Wavelength series
1064nm	10W-20W	200µm/400µm/0.22	15pin	

### Ordering Information: STK-XXX-Y-ZZ-A-PPPPW-CC

STK – STK series laser diodes

XXX – laser wavelength, such as 405nm, 808nm,....

Y – S with pilot beam; D without pilot beam

ZZ – package, 01 means 2PIN, 03 means co-axial, 06 means 6PIN, 14 means 14PIN, 15 means 15PIN

A – output method, F means fiber, C means insert, W means window, M means module

PPPP -- output laser power

CC - others

For example, STK808D06F-2.00W, fiber coupled laser diode with 808nm wavelength, 6PIN package, 2W output.

### 1.5 Details of STK Series Fiber-coupled Diode Lasers

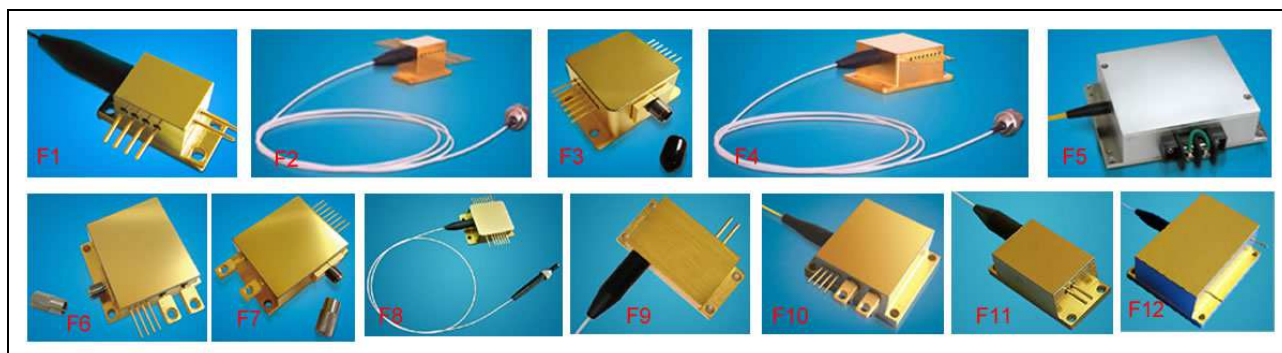

### 808nm Diode Lasers

Part Number		STK808S06F-2W	STK808S14F-2W	STK808D14C-2W-FS	STK808D06F-2W
Optical Parameter	Laser power(W)	2	2	2	2
	Wavelength(nm)	808	808	808	808
	Tolerance(nm)	±3, ±10	±3, ±10	±3, ±10	±3, ±10
	Spectral width(nm)	<3	<3	<3	<3
	Temperature drift (nm/K)	0.3	0.3	0.3	0.3
Fiber Data	Core dia.(um)	105, 200	105	200	105, 200
	NA	0.22	0.22	0.22	0.22
	Connector	SMA905	SMA905	SMA905	SMA905
Electrical Parameter	Operation(A)	2.5	2.5	2.5	2.5
	Threshold current(A)	0.4	0.4	0.4	0.4
	Operation voltage(V)	1.9	1.9	1.8	1.9
Others	Operation temp.(°C)	10-30	10-30	10-30	10-30
	Store temp.(°C)	-20+80	-20+80	-20+80	-20+80
	Life(hours)	>10,000	>10,000	>10,000	>10,000
	Dimension(mm)	26x12.7x12.5	30x12.7x14.8	44.5x31.8x18	26x12.7x12.5
	Outlook	Fig. 1	Fig. 2	Fig. 3	Fig. 1
TEC Parameter	Max. current(A)		2.2	4	
	Max. voltage(V)		8.7	9.8	
Pilot beam				Yes	Yes

Part Number		STK808S06F-4W	STK808D14C-4W-FS	STK808S09F-4W	STK808D06F-4W
Optical Parameter	Laser power(W)	4	4	4	4
	Wavelength(nm)	808	808	808	808
	Tolerance(nm)	±3, ±10	±3, ±10	±3, ±10	±3, ±10
	Spectral width(nm)	<3	<3	<3	<3
	Temperature drift (nm/K)	0.3	0.3	0.3	0.3
Fiber Data	Core dia.(um)	105, 200	200	105, 200	105, 200
	NA	0.22	0.22	0.22	0.22
	Connector	SMA905	SMA905	SMA905	SMA905
Electrical Parameter	Operation(A)	5	5	5	5
	Threshold current(A)	0.8	0.8	0.8	0.8
	Operation voltage(V)	1.9	2.1	1.9	1.9
Others	Operation temp.(°C)	10-30	10-30	10-30	10-30
	Store temp.(°C)	-20+80	-20+80	-20+80	-20+80
	Life(hours)	>10,000	>10,000	>10,000	>10,000
	Dimension(mm)	26x12.7x12.5	44.5x31.8x18	44.5x31.8x18	26x12.7x12.5
	Outlook	Fig. 1	Fig. 2	Fig. 4	Fig. 1
TEC Parameter	Max. current(A)		4	4	4
	Max. voltage(V)		9.8	9.8	9.8
Pilot beam			Yes		Yes

Part Number		STK808D14C-8W-FS	STK808S09F-8W	STK808D15F-8W	STK808S02M-10W
Optical Parameter	Laser power(W)	8	8	8	10
	Wavelength(nm)	808	808	808	808
	Tolerance(nm)	±3, ±10	±3, ±10	±3, ±10	±10
	Spectral width(nm)	<3	<3	<3	
	Temperature drift (nm/K)	0.3	0.3	0.3	0.3
Fiber Data	Core dia.(um)	200	200, 400	200, 400	375
	NA	0.22	0.22	0.22	0.22

	Connector	SMA905	SMA905	SMA905	SMA905
Electrical Parameter	Operation(A)	10	10	10	2.6
	Threshold current(A)	1.5	1.5	1.5	0.4
	Operation voltage(V)	2.2	2.2	2.18	10
Others	Operation temp.(°C)	10-30	10-30	10-30	10-30
	Store temp.(°C)	-20+80	-20+80	-20+80	-20+80
	Life(hours)	>10,000	>10,000	>10,000	>10,000
	Dimension(mm)	44.5x31.8x18	44.5x31.8x18	44.5x31.8x18	123x80x25
	Outlook	Fig. 3	Fig. 4	Fig. 8	Fig. 5
TEC Parameter	Max. current(A)	6	6	6	
	Max. voltage(V)	9.8	9.8	9.8	
Pilot beam		Yes		Yes	

Part Number		STK808S02M-15W	STK808SABC-15W	STK808SABC-30W	STK808DANC-30W-FS
Optical Parameter	Laser power(W)	15	15	30	30
	Wavelength(nm)	808	808	808	808
	Tolerance(nm)	±10	±3	±3	±3, ±10
	Spectral width(nm)		<3	<3	<3
	Temperature drift (nm/K)	0.3	0.3	0.3	0.3
Fiber Data	Core dia.(um)	375	400	400	400
	NA	0.22	0.22	0.22	0.22
	Connector	SMA905	SMA905	SMA905	SMA905
Electrical Parameter	Operation(A)	3	9	9.5	10
	Threshold current(A)	0.4	1.2	1.2	1.2
	Operation voltage(V)	14	3.8	7.8	7.8
Others	Operation temp.(°C)	10-30	10-30	10-30	10-30
	Store temp.(°C)	-20+80	-20+80	-20+80	-20+80
	Life(hours)	>10,000	>10,000	>10,000	>10,000
	Dimension(mm)	123x80x25	47x40x20	47x40x20	52x35x20
	Outlook	Fig. 5	Fig. 6	Fig. 6	Fig. 7
Pilot beam				Yes	

#### Specifications of Pilot Beam

Laser power(mW)	>2
Laser wavelength(nm)	650
Operation voltage(V)	2.2
Operation current(mA)	<30

#### 9XXnm Diode Lasers

Part Number		SYK976S06F-3W	SYK976S14F-3W	SYK976SA2F-9W-R-G	SYK976D14C-10W-FS
Optical Parameter	Laser power(W)	3	3	9	10
	Wavelength(nm)	976	976	976	976
	Tolerance(nm)	±3, ±10	±3, ±10	±0.5	±3, ±10
	Spectral width(nm)	<3	<3	<0.5	<3
	Temperature drift (nm/K)	0.3	0.3	0.02	0.3
Fiber Data	Core dia.(um)	105, 200	105	105	200
	NA	0.22	0.22	0.22	0.22
	Connector	SMA905	SMA905	SMA905	SMA905
Electrical Parameter	Operation(A)	4	3.8	11.5	12
	Threshold current(A)	0.4	0.4	0.6	0.5
	Operation voltage(V)	1.8	1.8	1.8	1.9
Others	Operation temp.(°C)	10-30	10-30	10-30	10-30
	Store temp.(°C)	-20+80	-20+80	-20+80	-20+80
	Life(hours)	>10,000	>10,000	>100,000	>10,000

	Dimension(mm)	30x12.7x14.8	30x12.7x14.8	26x12.7x12.5	44.5x31.8x18
	Outlook	Fig. 1	Fig. 2	Fig. 11	Fig. 3
TEC Parameter	Max. current(A)		2.2		6
	Max. voltage(V)		8.7		9.8
Pilot beam					Yes

Part Number		SYK976S09F-10W	SYK976D15F-10W	SYK976S02M-10W	SYK976S02M-15W
Optical Parameter	Laser power(W)	10	10	10	15
	Wavelength(nm)	976	976	976	976
	Tolerance(nm)	±3, ±10	±3, ±10	±10	±10
	Spectral width(nm)	<3	<3		
	Temperature drift (nm/K)	0.3	0.3	0.3	0.3
Fiber Data	Core dia.(um)	105, 200	105, 200	375	375
	NA	0.22	0.22	0.22	0.22
	Connector	SMA905	SMA905	SMA905	SMA905
Electrical Parameter	Operation(A)	12	12	3.6	3.8
	Threshold current(A)	0.5	0.5	0.3	0.3
	Operation voltage(V)	1.9	1.9	6	10
Others	Operation temp.(°C)	10-30	10-30	10-30	10-30
	Store temp.(°C)	-20+80	-20+80	-20+80	-20+80
	Life(hours)	>10,000	>10,000	>10,000	>10,000
	Dimension(mm)	44.5x31.8x18	44.5x31.8x18	123x80x25	123x80x25
	Outlook	Fig. 4	Fig. 8	Fig. 5	Fig. 5
TEC Parameter	Max. current(A)	6	6		
	Max. voltage(V)	9.8	9.8		
Pilot beam			Yes		

Part Number		SYK976SABF-25W-R-G	SYK9XXSA3F-25W-R	STK9XXSA3F-30W-R	STK9XXDANC-30W-FS
Optical Parameter	Laser power(W)	25	25	30	30
	Wavelength(nm)	976	915,940,976	915,940,976	915,940,976
	Tolerance(nm)	±0.5	±3, ±10	±3, ±10	±3, ±10
	Spectral width(nm)	<0.5	<5	<5	<3
	Temperature drift (nm/K)	0.02	0.3	0.3	0.3
Fiber Data	Core dia.(um)	105	105	105	200
	NA	0.22	0.15	0.15	0.22
	Connector	SMA905	SMA905	SMA905	SMA905
Electrical Parameter	Operation(A)	11	10	12	9.5
	Threshold current(A)	0.6	0.5	0.5	0.5
	Operation voltage(V)	5.4	5.4	5.4	7
Others	Operation temp.(°C)	10-30	10-30	10-30	10-30
	Store temp.(°C)	-20+80	-20+80	-20+80	-20+80
	Life(hours)	>100,000	>100,000	>100,000	>10,000
	Dimension(mm)	47x42x20	42x25x17	42x25x17	52x35x20
	Outlook	Fig. 10	Fig. 9	Fig. 9	Fig. 7
Pilot beam				Yes	

Part Number		STK940SG3-50W-R	STK976SG3-50W-R	STK915FN1RN-150	STK915FN1RN-180
Optical Parameter	Laser power(W)	50	150	50	180
	Wavelength(nm)	940	915	976	915
	Tolerance(nm)	±0.5	±10	±3, ±10	±10
	Spectral width(nm)	<0.5	<6	<5	<6

	Temperature drift (nm/K)	0.3	0.3	0.3	0.3
Fiber Data	Core dia.(um)	105	106.5	105	106.5
	NA	0.22	0.22	0.15	0.22
	Connector	SMA905	--	SMA905	--
Electrical Parameter	Operation(A)	12	22.8	12	17
	Threshold current(A)	0.5	1.1	0.5	1.2
	Operation voltage(V)	10.8	14	10.8	23
Others	Operation temp.(°C)	10-30	15-35	10-30	15-35
	Store temp.(°C)	-20-+80	-20-+70	-20-+80	-20-+70
	Dimension(mm)	60x50x25	80x80x24.8	60x50x25	80x80x24.8
	Outlook	Fig. 12		Fig. 12	

#### Specifications of Pilot Beam

Laser power(mW)	>2
Laser wavelength(nm)	650
Operation voltage(V)	2.2
Operation current(mA)	<30

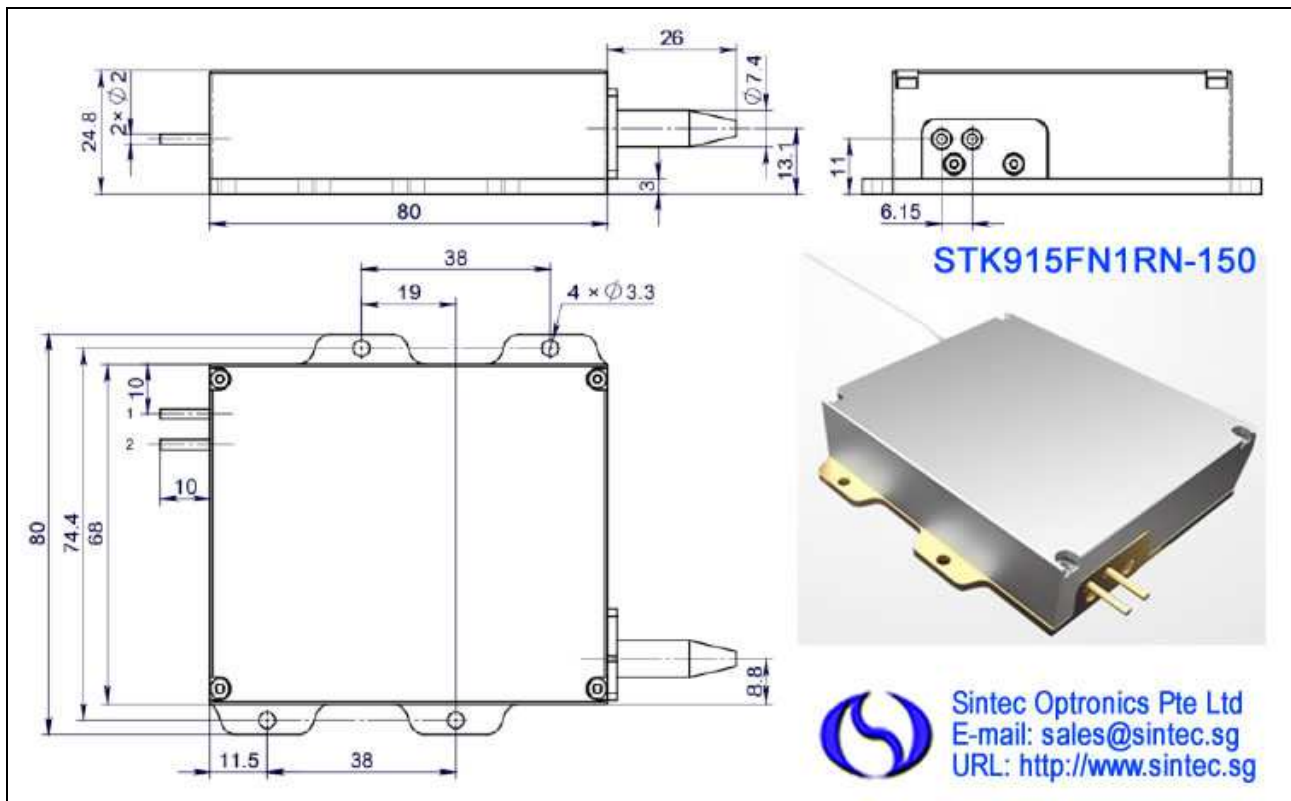

<b>Part number</b>	<b>STK915/940/976/981-500</b>
Output Laser Power	500W
Laser Wavelength	915 or 940 or 976 or 981nm
Output Fiber Core Diameter	220/300µm
Fiber Cable Length	10 m
Output Connector	QBH
Red Pilot	Red
Red Pilot Beam Power	>0.5mW
Operation Mode	Continuous or Modulation
Polarization	Random
Power Stability @25C	<3% (2h)
Power Adjustment Range	10-100%
Max Modulation Frequency	5kHz
Power Input	220±20VAC, 50/60Hz, PE



Power Consumption	1.5kW
Control Interface	RS-232/AD
Required Min. Cooling Capacity	1.5kW
Cooling Water Temperature	20-30°C
Storage Temp	-10-+60°C
Working Temp	10-40°C
Relative Humidity	10% -70%
Cooling Tubes Outside Dia.	16mm
Cooling Water Flux	>5L/min
QBH Cooling Water Flux	1.5-2.0L/min

## 2. STK Series Fiber Coupled Diode Lasers Rack Mounted Systems

We offer diode laser rack mounted subsystems ranging from wavelength 450nm to 1550nm and the output can be up to 300 watt. The system can integrate several functions upon customizable request. Compact and operate-friendly designs make it very easy to use. To meet customer's specific demanding and provide high quality products and laser solutions are our eternal pursuit.



Wavelength	Power	Fiber
635nm	400mW	105μm,200μm,400μm, 0.22
808nm	2mW-300W Customizable	105μm,200μm,400μm, 0.22
915nm	2mW-300W Customizable	105,200μm,400μm, 0.22
980nm	2mW-300W Customizable	105μm,200μm,400μm, 0.22

## STK-DS3 Fiber-coupled Diode Laser Systems

We are providing diode laser, fiber laser, ultra-fast laser products and solutions to global customers. The company pursues continuous innovation and insists on autonomous and controllable advanced process and technology. Up to now, we have sold more than 10 million lasers worldwide and covered more than 70 countries and regions. The applications involved industry, medical, commercial, scientific research, information and many other fields.



### Features:

- 9XXnm wavelength or Customized
- 1W~400W output power
- 105/135/200/400 $\mu$ m core diameter
- 0.22NA
- Multiple optional cabinet size

### Applications:

- Plastic welding
- 3D Printing
- Soldering

Specifications (25 $^{\circ}$ C)		Unit	STK-DS3-5152X <sup>(1)</sup> -LD
Optical Data <sup>(2)</sup>	CW Output Power	W	1~400
	Central wavelength	nm	9XX or Customized
	Spectral width(FWHM)	nm	$\pm 10$ / Customized
	Wavelength shift with temperature	nm	$\leq 6$
	Output power instability (25 $^{\circ}$ C)	%	$\pm 3$ (5 hours)
	Power Range	%	10~100
Fiber Data <sup>(2)</sup>	Core diameter	$\mu$ m	105/135/200/400
	Numeric aperture	-	0.22
	Fiber length	m	2 / Customized
	Fiber termination	-	SMA905 / Customized
Electrical Data	Power supply	V	100~240 (50-60Hz)
	Power consumption	W	<1200
	Drive mode	-	Constant current
	Emission mode	-	CW or Modulated 1 Hz to 20kHz,
	Control mode	-	Touch screen, RS232, I/O
	Modulation frequency	Hz	1~20K (DC>0.01%)
	Modulation Pulse Width	-	20 $\mu$ s -950ms (Pulse)/20 $\mu$ s-999ms (Single Pulse)
	Modulation Rise/Fall Time (Min. Value)	$\mu$ s	$\leq 10$
Aiming Beam Data <sup>(3)</sup>	Current	A	<12
	Central wavelength	nm	635 $\pm 10$ nm
Mechanical	CW Output Power	mW	2
	Dimensions (L $\times$ W $\times$ H) <sup>(4)</sup>	mm	S size: 260x360x125 M size: 340x438x145 L size: 430x482x130
	Weight	kg	<15
Others	Cooling method	-	Air cooling/Water-cooling
	Storage temperature <sup>(5)</sup>	$^{\circ}$ C	5~50

	Temperature Ambient in Operation <sup>(5)</sup>	°C	15~30
	Cooling requirement	-	Air cooling: Internal fan, At least 10 cm space outside fan Water cooling: temperature 20 °C - 25 °C Quick coupling: 2* Φ 12 water inlet and outlet interface Circulating water pressure 0.25MPa, Circulating water flow 7L / min
	Relative Humidity	%	5~80
	Safety class	-	4 (EN 60825-01)

(1) x=2 means air cooling, x=4 means water cooling; Lasers of 300W and above are all water-cooled. In the part number STK-DS3-5152X-LD, LD is the part number of STK series fiber-coupled diode lasers used in the laser system.

(2) Consult us for other available options. In fact, the optical, fiber and electrical parameters more depend on the diode laser matched. All STK series diode lasers can be used in the laser systems.

(3) The aiming beam can be customized according to customer requirements.

(4) The mechanical dimensions depend on the laser power and cooling mode and please consult us for more information. At the moment, there are 3 cabinets for your selection. Custom-design and -made available.

(5) A non-condensing environment is required for operation and storage

Example: STK-DS3-51522-K940EB2RN-10.00W is 940nm, air-cooled 10W fiber coupled diode laser with fiber core diameter 105µm and NA 0.22.

Remarks:

- Avoid eye and skin exposure to direct radiation during operation.
- Make sure the fiber output end is properly cleaned before operation of laser. Follow safety protocols to avoid injury when handling and cutting the fiber.
- Laser diode must be used according to the specifications.
- Temperature Ambient in Operation ranges from 15°C to 30°C.
- Storage temperature ranges from 5°C to 50°C.

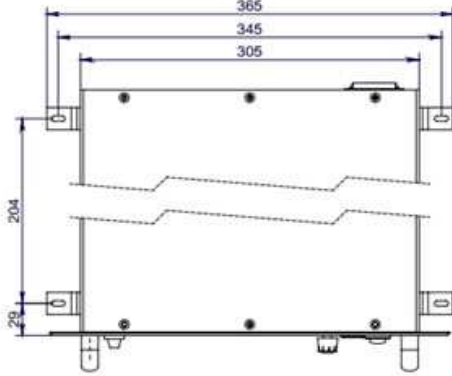
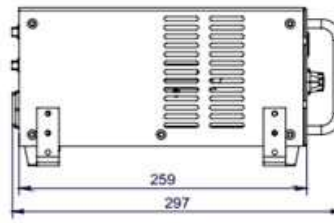
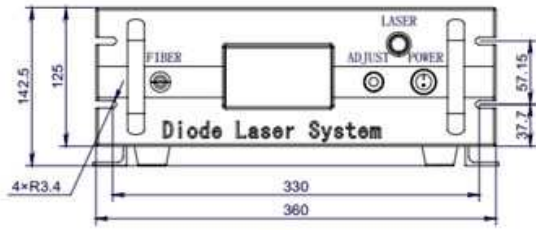

S size

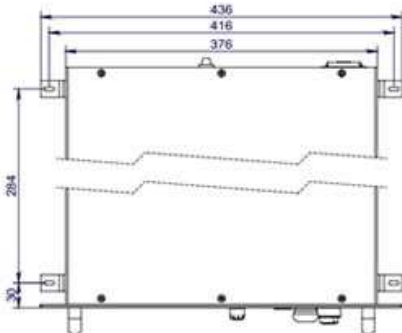
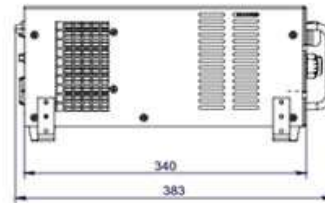
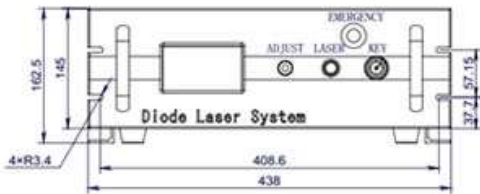

M size

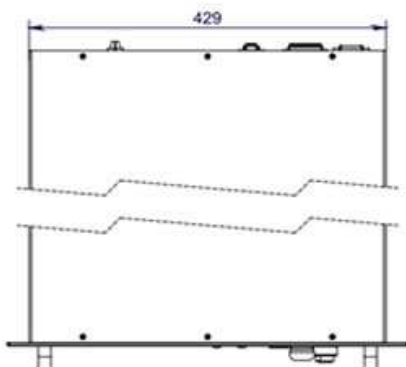
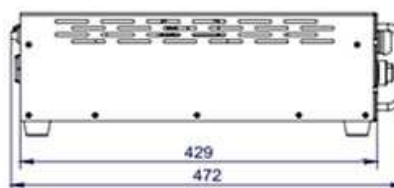
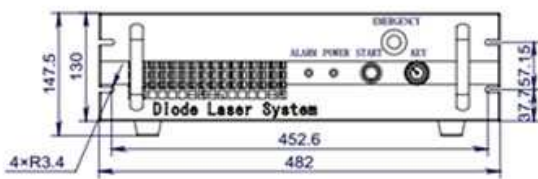

L size

## 1000W Fiber-coupled Diode Laser System



### FEATURES

- Low cost
- Maintenance free operation
- Modulation frequency up to 5kHz
- High wall-plug efficiency
- Excellent power stability
- Outstanding reliability
- Convenient control interface

### APPLICATION

- Welding
- Surface treatment
- Cladding
- Li battery manufacture

Our Laser 1000W DDL (Direct Diode Laser) is designed for precision materials processing. With two optional modes, continuous mode and pulse mode, HAZ (heat affected zone) can be minimized. The system is designed for outstanding reliability and can be operated in harsh industrial application environment. Our Laser 1000W DDL are suitable for many applications, such as welding, cladding, Li battery soldering, etc.

### Technical Specification

Part number	STK-BDL-CW1000
Power	1000W
Wavelength	915 / 976nm
Output Fiber Core Diameter	330μm
Cable Length	10m or Customized
Beam Delivery	QBH
Guide Beam	Red
Operation Mode	Continuous or Modulated
Polarization	Random
Power Stability (25 °C)	<3% (2h)
Power Adjustment Scope	10%-100%
Max Modulation Frequency	5kHz
Weights	<35Kg
Outline Feature	153 mmx482mmx378mm
Voltage	Single Phase, 220±20V, AC, PE, 50/60Hz
Power Consumption	2.4 kW
Control Interface	RS232
Minimum Water Cooling Capacity	1.5 kW
Temperature Settings	25 °C (Laser Module), 30 °C (QBH)
Cooling Tubes Size (External)	Φ12mm
Cooling Water Flux	>10L/min
QBH Cooling Water Flux	1.5~2.0L/min

Note: The back reflection will affect the performance and life of the direct diode laser. It is necessary to use the output laser when it is 8 ° - 10 ° away from the vertical direction of the surface.

## 2000W Fiber-coupled Diode Laser System



### FEATURES

- Low cost
- Maintenance free operation
- Modulation frequency up to 5kHz
- High wall-plug efficiency
- Excellent power stability
- Outstanding reliability
- Convenient control interface

### APPLICATION

- Welding
- Surface treatment
- Cladding
- Li battery manufacture

Our Laser 2000W DDL (Direct Diode Laser) is designed for precision materials processing. With two optional modes, continuous mode and pulse mode, HAZ (heat affected zone) can be minimized. The system is designed for outstanding reliability and can be operated in harsh industrial application environment. Our Laser 2000W DDL are suitable for many applications, such as welding, cladding, Li battery soldering, etc.

Part number	STK-BDL-CW2000
Power	2000W
Wavelength	915 / 976nm
Output Fiber Core Diameter	600µm
Cable Length	10m or Customized
Beam Delivery	QBH
Guide Beam	Red
Operation Mode	Continuous or Modulated
Polarization	Random
Power Stability (25 °C)	<3% (2h)
Power Adjustment Scope	10%-100%
Max Modulation Frequency	5kHz
Weights	<35Kg
Outline Feature	153 mm*482mm*378mm
Voltage	Single Phase, 220±20V, AC, PE, 50/60Hz
Power Consumption	2.4 kW
Control Interface	RS232
Minimum Water Cooling Capacity	1.5 kW
Temperature Settings	25°C (Laser Module), 30°C (QBH)
Cooling Tubes Size (External)	Φ12mm
Cooling Water Flux	>20L/min
QBH Cooling Water Flux	1.5~2.0L/min

Note: The back reflection will affect the performance and life of the direct diode laser. It is necessary to use the output laser when it is 8 ° - 10 ° away from the vertical direction of the surface.