

STC Series Lasers











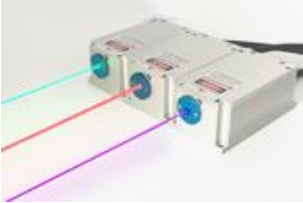

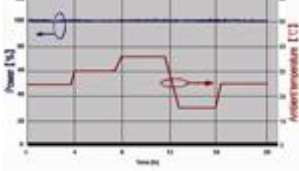
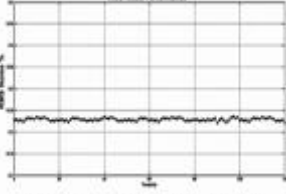
- **CW DPSS series:** CW DPSS lasers cover from 261nm to 1645nm, including the single longitudinal mode lasers, low noise lasers and multimode lasers with stabilized output power and good beam profile.
- **Direct diode series:** The most reliable technology, cover the wavelength from 375nm to 2200nm. The new OEM version integrates the control electronics in the laser head with ultra-compact size.
- **Q-switched series:** Stable single pulse energy, and narrow pulse width in passive and active operating mode. Maximum Single pulse energy is up to 20 J and output power is up to 500 W available.
- **Tunable series:** The output wavelengths can be changed continuously within a certain range. Tunable lasers come with good beam quality, high stability and long life time, they are widely used in spectroscopy, photochemistry, medicine, biology, integrated optics, laser processing
- **Fiber laser series:** Widely used in communication, radar, medical cosmetology, optical instrument, interference, holography, spectrum analysis, pump source, measurement, physics experiment, etc.
- **Mode-locked & Picosecond Laser Series:** Superior beam quality, best reliability, pulsed duration could be less than 20ps.
- **High power fiber coupled laser system:** Fiber Coupling Laser System have integrated laser diode, fiber coupling optics, laser power supply, LD current and temperature control in ONE box. Its compact dimension and convenient functions, such as power adjustment, temperature control, LED display etc, make it very suitable for pumping, scientific research, industrial and medical applications.

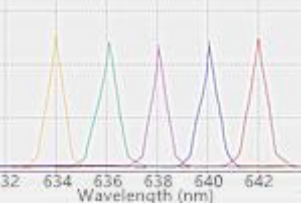
Sorted by Wavelength

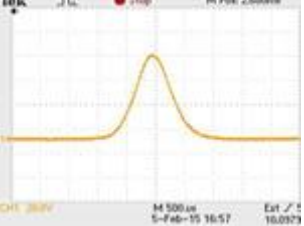

Available laser wavelengths are 257nm, 261nm, 266nm, 303nm, 320nm, 349nm, 351nm, 355nm, 360nm, 375nm, 395nm, 397nm, 400nm, 405nm, 410nm, 415nm, 420nm, 425nm, 430nm, 440nm, 442nm, 445nm, 447nm, 450nm, 454nm, 457nm, 460nm, 462nm, 465nm, 470nm, 473nm, 480nm, 488nm, 491nm, 501nm, 505nm, 510nm, 514nm, 515nm, 520nm, 522nm, 523nm, 526nm, 530nm, 532nm, 540nm, 543nm, 550nm, 552nm, 555nm, 556nm, 561nm, 577nm, 588nm, 589nm, 594nm, 604nm, 607nm, 612nm, 622nm, 627nm, 633nm, 635nm, 637nm, 639nm, 640nm, 642nm, 650nm, 655nm, 656nm, 660nm, 665nm, 666nm, 671nm, 680nm, 685nm, 689nm, 690nm, 698nm, 705nm, 721nm, 730nm, 750nm, 760nm, 785nm, 786nm, 793nm, 800nm, 808nm, 825nm, 830nm, 845nm, 852nm, 860nm, 879nm, 880nm, 885nm, 905nm, 914nm, 915nm, 940nm, 946nm, 965nm, 975nm, 980nm, 1030nm, 1040nm, 1047nm, 1053nm, 1060nm, 1064nm, 1080nm, 1085nm, 1105nm, 1112nm, 1120nm, 1122nm, 1177nm, 1208nm, 1268nm, 1275nm, 1310nm, 1313nm, 1319nm, 1320nm, 1342nm, 1380nm, 1392nm, 1413nm, 1444nm, 1450nm, 1470nm, 1490nm, 1532nm, 1540nm, 1550nm, 1560nm, 1573nm, 1590nm, 1600nm, 1610nm, 1645nm, 1710nm, 1850nm, 1870nm, 1900nm, 1910nm, 1940nm, 1990nm, 2096nm, 2200nm, 2796nm, 2940nm, 3000nm, 3200nm, 3400nm, 3600nm, 3800nm, 4000nm, 4200nm, 4400nm, 4500nm, 4600nm, 4800nm, 4900nm.

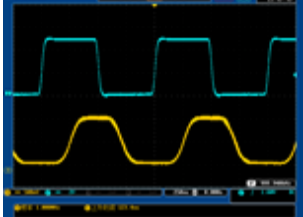
Sorted by Laser Performance

 <p>DPSS Laser High stability, low noise, ultra narrow linewidth, high power & energy, picosecond laser...</p>	 <p>Diode Laser Narrow linewidth, DFB laser, long coherence length, picosecond laser..</p>	 <p>Fiber Laser SM/ MM fiber!, pulse width <200ps or tunable 1~250 ns. Modulation up to 1 MHz</p>	 <p>Multi-wavelength Laser Multi-wavelength (2~20) output, free space or fiber coupling output optional.</p>
 <p>Power stability<1%, 20 hours) environment temperature 10-35°C</p> <p>High Stability Laser Wavelength: 257-4800nm Power stability <0.1%, 0.3%, 0.5%, 1%.</p>	 <p>Noise of Amplitude(pk-pk, 1~20MHz)<0.25%</p> <p>Low Noise Laser Noise of amplitude <0.2% Power stability <0.1%, 0.3%, 0.5%, 1%.</p>	 <p>Single Frequency Laser Single longitudinal mode lasers, Coherent length >100 m, Linewidth <0.000001nm</p>	 <p>Wavelength Tunable Laser Multi-wavelength bands optional, Min. linewidth <0.06nm</p>
 <p>High Power Laser Wavelength: 532/ 556/ 589 /660/ 1064/ 1319 nm, Power: 1W~500W</p>	 <p>High Energy Laser Wavelength: 266/ 355/ 532/1064/1319/1573nm, Energy: 1mJ~20J</p>	 <p>Q-switched Pulsed Laser Pulse duration: 0.8ns~200 ns; Rep. rate: 1Hz~200kHz</p>	 <p>Mode-locked & ps Laser Pulse duration <10ps; Rep. rate: 0.1-80MHz</p>
 <p>OEM Laser Module Ultra compact size and high compatibility, suitable for OEM instrumentation and systems.</p>	 <p>Fiber Coupled Diode Laser MM/ SM/ PM or liquid-core fiber optional, with high coupling efficiency and good homogenization effect.</p>	 <p>High Frequency Modulation Up to 150 MHz modulation rate, for single longitudinal mode and high stability laser.</p>	 <p>Line Laser Fan angles of 5°, 7°, 10°, 30°, 45° 60°, 75°, 90° and 100°, line beam uniform and with good flatness.</p>

Customized lasers

We specialize in designing and manufacturing custom-made and OEM lasers to suit our clients' particular needs. If you don't find a specific product or accessory from above listed products, please contact us for custom-design and fabrication. We can re-design the optical, mechanical, and/or electrical components of the lasers to provide the perfect solution for you. We have the R&D, engineering, and production expertise to manufacture the lasers that are able to maintain integrity in various extreme settings and conditions.

Sorted Lasers by Laser Wavelengths

1. 266 nm UV Solid State Lasers

1) UV Laser at 261 nm	<ul style="list-style-type: none"> ● 261/ 1~10mW
2) Passively Q-switched UV Laser at 266nm	<ul style="list-style-type: none"> ● STC-MPL-F-266/ 0.1~3uJ/ 1~10mW ● STC-MPL-Q-266/ 0.1~3uJ/ 1~30mW ● STC-MPL-Q1-266/ 10uJ/ 10mW, Fixed rep. rate 1kHz ● STC-MPL-C-266/ 0.1~10uJ/ 1~30mW, Pulse width 1ns @1kHz ● STC-MPL-N-266/ 0.1~10uJ/ 1~120mW, Pulse width 1.3ns ● STC-MPL-W-266/ 5~30uJ/ 50~600mW
3) Actively Q-switched UV Laser at 266nm	<ul style="list-style-type: none"> ● STC-AO-S-266/ 1~5uJ/ 1~10mW ● STC-AO-W-266/ 1~20uJ/ 1~200mW ● STC-EO-266-G/ 4~100uJ, High beam quality ● STC-EO-266-N/ 4~150uJ ● STC-DPS-266-Q/ 2~5mJ
4) Picosecond Pulsed UV Laser at 266nm	<ul style="list-style-type: none"> ● STC-PS-R-266/ 1~50mW, Pulse duration<20ps (Mode-locked) ● STC-DPS-266-Pico/ 100~500mW, Repetition frequency 5MHz
5) Fiber Laser at 266nm	<ul style="list-style-type: none"> ● STC-FL-266-PS/ 1~10mW, Pulse duration <10ps ● STC-FL-266-Pico/ 1~50mW, Pulse duration <900ps ● STC-FL-266-Nano/ 1~50mW

2. 355 nm UV Solid State Lasers

1) High Stability UV Laser at 355nm	<ul style="list-style-type: none"> ● STC-UV-F-355/ 1~10mW ● STC-UV-FN-360/ 1~200mW
2) Passively Q-switched UV Laser at 355nm	<ul style="list-style-type: none"> ● STC-MPL-F-355/ 0.1~15uJ/1~100mW ● STC-MPL-Q-355/ 0.1~15uJ/1~150mW Pulse width 1.3ns ● STC-MPL-N-355/ 0.1~90uJ/ 1~800mW ● STC-MPL-W-355/ 25~80uJ/ 400~2000mW
3) Actively Q-switched UV Laser at 355nm	<ul style="list-style-type: none"> ● STC-AO-S-355/ 1~40uJ/ 1~100mW ● STC-AO-L-355/ 40~100uJ/ 1~300mW ● STC-AO-V-355/ 1~100uJ/ 1~2W ● STC-AO-V-355-Water/ 1~250uJ/ 1~5W ● STC-EO-XS-355/ 1~50uJ/ 1~2W ● STC-EO-355-G/ 4~150uJ Good beam quality ● STC-EO-355-N/ 4~250uJ ● STC-DPS-355-E/ 1~2mJ ● STC-DPS-355-Q/ 2~10mJ Water cooled
4) Picosecond Pulsed UV Laser at 355nm	<ul style="list-style-type: none"> ● STC-DPS-355-Pico/ 100~700mW ● STC-PS-R-355/ 1~2000mW ● STC-DPS-355-PS/ 1~6000mW Water cooled
5) Lamp Pumped Q-switched Laser at 355nm	<ul style="list-style-type: none"> ● STC-LPS-355-S/ 20~80mJ ● STC-LPS-355-L/ 80~200mJ
6) Fiber Laser at 355nm	<ul style="list-style-type: none"> ● STC-FL-355-PS/ 1~50mW Pulse duration <10ps ● STC-FL-355-Pico/ 1~50mW Pulse duration <900ps ● STC-FL-355-Nano/ 1~300mW
7) Fiber Coupled Laser System at 355nm	<ul style="list-style-type: none"> ● STC-MPL-355 (FC)/ 1~1500mW

3. 532 nm Green Solid State Lasers

We offer the diverse of 532nm laser sources for a broad range of industrial, medical and scientific applications. For CW operating mode lasers, the output power is up to 20W available. For Q-switched

operating mode lasers, the high power laser series is up to 200W available, and high energy laser series is up to 450mJ available.

1) High Stability Laser	Perfect beam quality; Long-term stability <1%
2) Low Noise Laser	RMS noise <1.0% (<0.5% optional); Linewidth <0.003nm optional
3) Single Frequency Lasers (Single Longitudinal Mode)	Ultra low noise <0.5%; Line width <0.00001nm
4) Q-switched Laser	ns laser (pulse width 1-100ns)
5) Mode-locked & ps Laser	Mode-locked laser (pulse width down to 10ps)
6) Fiber Laser	Modulation up to 80MHz; Pulse width down to 10ps
7) Line Generated Laser	Line uniformity <20%; Line straightness $\pm 0.1\%$
8) OEM Laser Module	Ultra compact; Industrial integration

3.1 532nm High Stability Laser Series

High stability 532 nm laser, housed in compact packages, are the perfect choice for design in and integration into OEM instrumentation and systems and also for end user applications in research and development.



Applications:

Confocal microscopy
 Laser medical treatment
 Scientific experiment
 Laser lighting show
 Optical instrument

Model	Operating mode	Output power	Power stability	M ² factor
STC-MGL-DS-532	CW	1~150mW	<1%	<1.2 (<1.1 optional)
STC-MXL-SM-532	CW	1~200mW	<1%	/
STC-MGL-III-532	CW	1~300mW	<1%	<1.2 (<1.1 optional)
STC-MGL-S-532	CW	1~300mW	<1%	<1.2 (<1.1 optional)
STC-STC-MGL-FN-532	CW	400~1500mW	<1%	<1.2 (<1.1 optional)
STC-STC-MGL-F-532	CW	1500~2500mW	<1%	<1.1
STC-MGL-N-532	CW	3~5W	<1%	<1.3
STC-MGL-R-532	CW	1~5W	<1%	<1.3
STC-OEM-N-532-Water	CW	1~5W	<1%	<1.3
STC-MGL-W-532-HQ	CW	1~10W	<1%	<1.2
STC-MGL-V-532	CW	5~15W	<1%	<1.2
STC-MGL-W-532	CW	5~20W	<1%	<1.5
STC-MGL-D-532	CW	20~30W	<1%	/
STC-HPL-532-CW	CW	1~80W	<3%	/
STC-HPL-532-Q	QCW	20~40W	<3%	/
STC-HPL-532-QM	QCW	40~100W	<3%	/
STC-HPL-532-QL	QCW	100~200W	<3%	/
STC-MGL-III-532-AOM	High modulation up to 1 MHz	1~150mW	<1%	1.5
STC-MGL-FN-532-AOM	High modulation up to 1 MHz	150~400mW	<1%	<1.5

3.2 532 nm Low Noise Laser Series

High performance CW, ultra low noise 532 nm lasers, narrow spectrum linewidth <0.003 nm. Housed in compact packages, are the perfect choice for design in and integration into OEM instrumentation and systems and also for end user applications in research and development.

Applications:

Fluorescence microscopy
DNA sequency, flow cytometry
Particle measurements
Spectrum analysis
Chip inspection



Model	Output power (mW)	Noise of amplitude (rms, 20Hz-20MHz)	M ² factor	Spectral line width (nm)
STC-MLL-III-532	1~300	<0.5%	<1.2 (<1.1 optional)	<0.1
STC-MLL-S-532	1~300	<0.5%	<1.2 (<1.1 optional)	<0.1
STC-MLL-U-532	1~400	<0.5%	<1.2	<0.003
STC-MLL-FN-532	1~1000	<0.5%	<1.2 (<1.1 optional)	<0.2 (<0.003 optional)
STC-MLL-F-532	1500~2500	<1%	<1.1	<0.1 (<0.003@1.5W)
STC-MGL-R-532	1~5 W	<1%	<1.3	<0.003
STC-MLL-N-532	3~5 W	<1%	<1.3	<0.1 (<0.01@3W)
STC-MLL-W-532	5~20 W	<1%	<3.0	<0.1 (<0.01@5W)
STC-OEM-V-532-LN	5~30 W	<1%	<1.2	<0.1

3.3 532nm Single Longitudinal Mode Laser Series

High performance CW, single longitudinal mode, ultra low noise 532 nm lasers, narrow spectrum linewidth <0.00001nm. Housed in compact packages, are the perfect choice for design in and integration into OEM instrumentation and systems and also for end user applications in research and development.



Applications:

Confocal microscopy
RAMAN spectroscopy
Particle measurements
DNA sequency, Flow cytometry
Digital imaging, Analytical chemistry

Model	Operating mode	Output power (mW)	Fiber coupling options	AOM option
STC-MSL-III-532	CW	1~100	SM/ PM/ MM	yes
STC-MSL-S-532	CW	1~100	SM/ PM/ MM	yes
STC-MSL-DS-532	CW	1~100	SM/ PM/ MM	yes
STC-MSL-U-532	CW	1~200	SM/ PM/ MM	yes
STC-MSL-FN-532	CW	200~400	SM/ PM/ MM	yes
STC-MSL-FN-532-S	CW	200~400	SM/ PM/ MM	yes
STC-MSL-F-532	CW	400~700	SM/ PM/ MM	yes
STC-MSL-RA-532	CW	700~2000	MM	/
STC-MSL-R-532	CW	2000~10000	MM	/
STC-MSL-III-532-AOM	High modulation up to 1MHz	1~30	SM/ PM/ MM	/
STC-MSL-FN-532-AOM	High modulation up to 1MHz	30~200	SM/ PM/ MM	/
STC-MSL-AO-532	Q- switched	1~100uJ@1Hz ~1kHz, 20ns	MM	/

3.4 532nm Q-switched Laser Series

We offer diverse of Q-switched 532 nm lasers in passively and actively modes. With pulse width in short nanosecond, and single pulse energy up to 450mJ. Are the perfect choice for the end user applications in research, medical and industry. Nanosecond lasers perform precision processing with excellent material removal rates for microelectronics, materials processing, and medical device manufacturing.

Applications:

Scientific Research
Life Science & Medical
Materials Processing
Microelectronics
OEM Integration



Model	Single pulse energy	Repetition rate	Pulse width (ns)	Operating mode (Q-switched)
STC-MPL-III-532	1-5 μ J	1-20 kHz	~5 (1.3 optional)	Passively
STC-MPL-T-532	1-10 μ J	0.1-15 kHz	~0.5	Passively
STC-MPL-SU-532	5-40 μ J	1-15 kHz	~1.3/ ~4	Passively
STC-MPL-H-532	5-50 μ J	1-30 kHz	~5 (1.3 optional)	Passively
STC-MPL-U-532	20-60 μ J	4-12 kHz	~4 (1.3 optional)	Passively
STC-MPL-N-532	50-125 μ J	1 k-15 kHz	~5	Passively
STC-AO-N-532	1-60 μ J	1-50 kHz	~10 < 10 kHz	Acousto-optic
STC-AO-S-532	1-100 μ J	0.1-50 kHz	5-10 @ < 10 kHz	Acousto-optic
STC-AO-W-532	1-300 μ J	1-50 kHz	~10 @ < 10 kHz	Acousto-optic
STC-AO-V-532	1-300 μ J	1-200 kHz	< 15 @ 25 kHz	Acousto-optic
STC-AO-L-532	1-600 μ J	0.001-200 kHz	~6 @ 5 kHz	Acousto-optic
STC-AO-X-532	1-670 μ J	30-100 kHz	~15 @ 30 kHz	Acousto-optic
STC-AO-U-532	500 μ J-1 mJ	1-3 KHz	< 15 @ 3 kHz	Acousto-optic
STC-EO-XS-532	1-125 μ J	1-100 kHz	~3.5 @ 40 kHz	Electro-optic
STC-EO-S-532	1-70 μ J	1-1000 Hz	~6	Electro-optic
STC-EO-532-G	0.2-0.5 mJ	1 Hz-25 kHz	< 8 @ 5 kHz	Electro-optic
STC-EO-532-H	0.5-1 mJ	1-10 kHz (fixed)	< 6 @ 5 kHz	Electro-optic
STC-EO-532-N	0.5-2 mJ	1 Hz-25 kHz	< 6 @ < 7 kHz	Electro-optic
STC-DPS-532-Pico	2-10 W	0.1-10 MHz	< 50 ps	Electro-optic
STC-DPS-532-H	1-10 mJ	1-1000 Hz	< 4	Electro-optic
STC-DPS-532-E	1.5-4 mJ	1-50 Hz	< 4	Electro-optic
STC-DPS-532-A	1-5 mJ	1-10 Hz	< 10	Electro-optic / Passively
STC-DPS-532-B	5-15 mJ	1-10 Hz	< 10	Electro-optic
STC-DPS-532-BS-D	15-50 mJ	1-20 Hz	< 10	Electro-optic
STC-DPS-532-Q	2-20 mJ @ 1-1000 Hz	1-1000 Hz	~10	Electro-optic
STC-DPS-532-J	1-20 mJ	1-20 Hz	~10	Electro-optic
STC-HPL-532-QT	1-13W	5-10 kHz	~150 @ 10 kHz	Acousto-optic
STC-HPL-532-Q	2-4mJ @ 10kHz	10-20 kHz	~100 @ 10 kHz	Acousto-optic
STC-HPL-532-QM	1-6mJ @ 15kHz	15 kHz	~100 @ 15 kHz	Acousto-optic
STC-HPL-532-QL	7-13mJ @ 15kHz	15 kHz	~100 @ 15 kHz	Acousto-optic
STC-HPL-532-QS	1-4.5mJ @ 10kHz	10 kHz	~5	Acousto-optic
STC-LPS-532-A	30-100 mJ	1-10 Hz	~10	Electro-optic
STC-LPS-532-S	30-150 mJ	1-20 Hz	~10	Electro-optic
STC-LPS-532-L	200-450 mJ	1-10 Hz	~10	Electro-optic

3.5 532nm Mode-locked & Picosecond Laser Series

Superior beam quality, best reliability, mode-locked & picosecond pulsed laser, pulsed duration could be less than 20ps. Housed in compact packages, are the perfect choice for design in and integration into OEM instrumentation and systems and also for end user applications in research and development.



Applications:

Raman spectroscopy; Marking, Carving; Material processing; Astronomy; Scientific research; Optical instrument

Mode-locked Type:

	Wavelength (nm)	Output power (mW)	Pulse duration (ps)	Rep. rate (MHz)	Operating mode	Transverse mode
STC-PS-R-532	532	1-3000	<20	48±1	Mode-locked	TEM ₀₀
STC-PS-HR-532	532	1-2 W	~15@500kHz&2 W	100-1000kHz	Mode-locked	TEM ₀₀

Fiber Laser Type:

	Wavelength (nm)	Output power (mW)	Pulse duration (ps)	Rep. rate (MHz)	Operating mode	Transverse mode
STC-FL-532-PS	532	1-150	<10	20-80 (Fixed)	Mode-locked	TEM ₀₀
STC-FL-532-Pico	532	1-1000	100-900	0.1-80 (variable)	Pulsed	TEM ₀₀

Diode Pumped Laser Type:

	Wavelength (nm)	Output power (mW)	Pulse duration (ps)	Rep. rate (MHz)	Operating mode	Transverse mode
STC-DPS-532-Pico	532	2-10 W	<50 ps	0.1-10 MHz	Pulsed	TEM ₀₀

3.6 532nm Fiber Lasers

We offer fiber lasers with compact OEM modular design which is ideal for systems integration. They are widely used in communication, lidar, medical cosmetology, optical instrument, interference, holography, spectrum analysis, pump source, measurement, physics experiment, etc. The pulsed mode up to 1MHz modulation and pulse duration variation are also available.

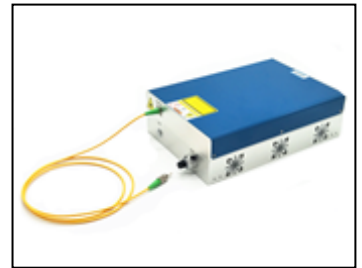



Model	Wavelength (nm)	Output power (mW)	Pulse width	Modulation rate	Longitudinal mode	Polarization
STC-FL-532-PS	532	1-150	<10 ps	20-60 MHz	Multi-	>15dB
STC-FL-532-Pico	532	1-1000	100-900 ps	0.1-20 MHz	Multi-	>15dB
STC-FL-532-Nano	532	1-1000	0.5-50 ns	0.1-1 MHz	Multi-	>15dB
STC-FL-532-AO	532	10-100 nJ	0.5-50 ns	1-1000 Hz	Multi-	Random/ >15dB

3.7 532 nm OEM Laser Modules

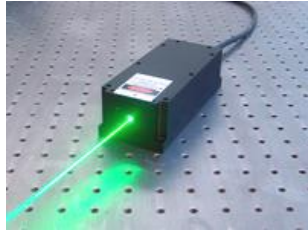
Green laser module at 532 nm are made features of ultra compact, low cost and easy operating, which are the perfect choice for design in and integration into OEM instrumentation and systems, and also for end user applications in scientific research, medical treatment and industrial development.

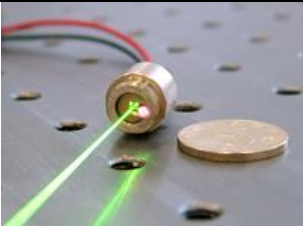
<p>High Power OEM Laser</p>		<ul style="list-style-type: none"> ● STC-OEM-S-532/ 1~300mW ● STC-OEM-U-532/ 300~1500mW ● STC-OEM-N-532/ 2000~5000mW ● STC-OEM-N-532-Water/ 1~5W Water cooled ● STC-OEM-W-532/ 5~18W ● STC-OEM-W-532-Water/ 5~10W Water cooled ● STC-OEM-I-532/ 5W Ultra compact ● STC-OEM-SW-532/ 10W Low heat ● STC-OEM-V-532/ 5~15W Water cooled ● STC-OEM-D-532/ 20-30W ● STC-OEM-D-532-Water/ 20-30W Water cooled
-----------------------------	---	---

Compact Laser Module		<ul style="list-style-type: none"> ● STC-PGL-I-R-532/ 1~50mW ● STC-S-GDL-532/ 1~80mW ● STC-PGL-VI-532/ 1~80mW ● STC-PGL-H-532/ 1~500mW ● STC-PGL-H1-532/1~800mW Beam divergence < 1.5 mrad
		<ul style="list-style-type: none"> ● STC-PGL-XII-E-532/ 1~50mW ● STC-PGL-FS-532/ 1~50mW ● STC-PGL-V-H-532/ 1~300mW
Fiber Coupled Laser Module		<ul style="list-style-type: none"> ● STC-PGL-FC-532/ 1~50mW

4. 1064 nm Infrared Solid State Laser

We offer the diverse of laser sources for a broad range of industrial, medical and scientific applications. For CW operating mode lasers, the output power is up to 500W available. Q-switched high power laser series is 300W maximum. The high energy laser series is up to 20J available.

1) High Stability Laser	Perfect beam quality; Long-term stability <1%
2) Low Noise Laser	RMS noise <1.0% (<0.5% optional); Line width <0.2nm
3) Single Frequency Lasers (Single Longitudinal Mode)	Ultra low noise <0.5%; Linewidth <0.00001nm
4) Q-switched Laser	Ns laser (pulse width 1-100ns)
5) Mode-locked & ps Laser	Mode-locked laser (pulse width down to 10ps)
6) Fiber Laser	Modulation up to 80MHz; Pulse width down to 10ps
7) OEM Laser Module	Ultra compact; Industrial integration
8) Fiber Pigtailed Laser	MM, SM, PM fiber optional; SMA, FC connector optional

4.1 1064nm Infrared Laser Series

High stability 1064 nm laser, housed in compact packages, are the perfect choice for design in and integration into OEM instrumentation and systems and also for end user applications in research and development.

Applications:

Confocal microscopy
Laser printing
Chip inspection
Particle measurements
Spectrum analysis
DNA sequencing



Model	Operating mode	Output power	Min. power stability	M ² factor
STC-MXL-SM-1064	CW	1~500 mW	<2%	/
STC-MIL-III-1064	CW	1~1500 mW	<1%	<1.5 (<1.2 optional)
STC-MIL-S-1064	CW	1~1500 mW	<1%	<1.2
STC-MIL-H-1064	CW	2~3 W	<1%	<2.0
STC-MIL-N-1064	CW	4~5 W	<1%	<3.0
STC-MIL-W-1064	CW	6~20 W	<1%	<2.0

STC-MIL-V-1064	CW	6~20 W	<1%	<2.0
STC-HPL-1064-Q	QCW	50~100 W	<3%	/
STC-HPL-1064-QM	QCW	100~300 W	<3%	/
STC-HPL-1064-CW	CW	50~100 W	<3%	/
STC-HPL-1064-CW	CW	100~500 W	<3%	/

4.2 1064nm Low Noise Laser Series

High performance CW, ultra low noise 1064 nm lasers, noise less than 1% and power up to 20W. Housed in compact packages, are the perfect choice for design in and integration into OEM instrumentation and systems and also for end user applications in research and development.

Applications:

Fluorescence microscopy
DNA sequencing, flow cytometry
Optical instrument
Chip inspection
Physics experiment



Model	Output power (mW)	Noise of amplitude (rms,20Hz-20MHz)	M ² factor	Spectral line width (nm)
STC-MLL-III-1064	1~1500	<1%	<1.5 (<1.2 optional)	<0.2
STC-MLL-S-1064	1~1500	<1%	<1.2	<0.2
STC-MLL-H-1064	2000~3000	<1%	<2.0	<0.2
STC-MLL-N-1064	4000~5000	<1%	<2.0	<0.2
STC-MLL-V-1064	6000~20000	<1%	<2.0	<0.2
STC-MLL-W-1064	6000~20000	<1%	<3.0 (typically)	<0.2

4.3 1064nm Single Longitudinal Mode Laser Series

High performance CW, single longitudinal mode, ultra low noise 1064 nm Lasers, narrow spectrum linewidth <0.00001 nm. Housed in compact packages, are the perfect choice for design in and integration into OEM instrumentation and systems and also for end user applications in research and development.

Applications:

Confocal microscopy
RAMAN spectroscopy
Holography
Particle measurements
DNA sequencing, flow cytometry
Digital imaging, Analytical chemistry



Model	Operating mode	Output power (mW)	Fiber coupling options	AOM options
STC-MSL-S-1064	CW	1~200	SM/ PM/ MM	yes
STC-MSL-S-1064-S	CW	1~200	SM/ PM/ MM	yes
STC-MSL-III-1064	CW	1~1000	SM/ PM/ MM	yes
STC-MSL-III-1064-S	CW	1~1000	SM/ PM/ MM	yes
STC-MSL-R-1064	CW	1000 ~10000	MM	/
STC-MSL-AO-1064	Q- switched	1~200uJ@1Hz~1kHz, 25ns	MM	/

4.4 1064nm Q-switched Laser Series

We offer diverse of Q switched 1064 nm lasers in passively and actively modes. With pulse width from 1.3ns to 150ns, and single pulse energy from 1uJ to 20J. These lasers are the perfect choice for the end user applications in research, medical and industry. Nanosecond lasers perform precision processing with excellent material removal rates for microelectronics, materials processing, solar and medical device manufacturing.

Applications:

Life Science & Medical
Materials Processing
Microelectronics
OEM Integration



Model	Single pulse energy/ Power	Repetition rate	Pulse width (ns)	Operating mode (Q-switched)
STC-MPL-III-1064	10-20 μ J	1-20 kHz	~3-25 (1.3 optional)	Passively
STC-OEM-P-1064	1-20 μ J	1-20 kHz	~1-5	Passively
STC-MPL-T-1064	1-35 μ J	0.1-20 kHz	~0.5	Passively
STC-MPL-H-1064	20-100 μ J	1-30 kHz	~10 (1.5 optional)	Passively
STC-MPL-SU-1064	20-200 μ J	1-15 kHz	~1.5/ ~1.8/ ~5	Passively
STC-MPL-FL-1064-A	15-130 μ J	1-70 kHz	~5 (1.3 optional)	Passively
STC-MPL-N-1064	150-200 μ J	1-15 kHz	~3-5 (<2 optional)	Passively
STC-MPL-FL-1064-B	150-300 μ J	1 kHz	~2 (1.0 optional)	Passively
STC-AO-S-1064	1-350 μ J	0.1-100 kHz	7-11 @<10 kHz	Acousto-optic
STC-AO-I-1064	500 μ J	1-100 kHz	~10 @20 kHz	Acousto-optic
STC-AO-N-1064	1-600 μ J	1-100 kHz	~7 @10 kHz	Acousto-optic
STC-AO-W-1064	1-600 μ J	1-100 kHz	~10 @<10 kHz	Acousto-optic
STC-AO-V-1064	1-600 μ J	1-200 kHz	~25 @30 kHz	Acousto-optic
STC-AO-L-1064	1-1500 μ J	0.001-200 kHz	~10 @10 kHz	Acousto-optic
STC-AO-M-1064	1-1000 μ J	1-20 kHz	~13 @20 kHz	Acousto-optic
STC-AO-H-1064	1-1000 μ J	10-100 kHz	~20 @30 kHz	Acousto-optic
STC-AO-X-1064	1-670 μ J	10-100 kHz	~20 @30 kHz	Acousto-optic
STC-EO-XS-1064	1~180 μ J	1-100 kHz	~4 @50 kHz	Electro-optic
STC-EO-HS-1064	1-320 μ J	1-100 kHz	~4 @50 kHz	Electro-optic
STC-EO-S-1064	1-300 μ J	1-1000 Hz	~8	Electro-optic
STC-EO-1064-G	0.5-1 mJ	1Hz-25 kHz	~8 @5 kHz	Electro-optic
STC-EO-1064-H	1-2 mJ	1-10 kHz	~7 @5 kHz	Electro-optic
STC-EO-1064-N	1-3.5 mJ	1Hz-25 kHz	~7 @<7 kHz	Electro-optic
STC-DPS-1064-Pico	5-30 W	0.1-10 MHz	<50ps, 50-1000 (adjustable)	Electro-optic
STC-DPS-1064-H	1~30 mJ	1~1000 Hz	<5	Electro-optic
STC-DPS-1064-D	0.5-2 mJ	1-100 Hz	<10	Electro-optic
STC-DPS-1064-E	3-8 mJ	1-50 Hz	<4	Electro-optic
STC-DPS-1064-P-Min	6 mJ	10/ 20 EXT (adjustable)	3 \pm 1	Passively
STC-DPS-1064-A	1-10 mJ	1-10 Hz	~10	Electro-optic / Passively
STC-DPS-1064-B	10-30 mJ	1-10 Hz	<10	Electro-optic
STC-DPS-1064-BS-D	30-100 mJ	1-20 Hz	<10	Electro-optic
STC-DPS-1064-Q	5-40mJ@1-1000Hz	1-1000 Hz	~10	Electro-optic
STC-DPS-1064-J	1-40mJ	1-20 Hz	~10	Electro-optic
STC-HPL-1064-Q	5-10 mJ@10kHz	10-20 kHz	~100 @10 kHz	Acousto-optic
STC-HPL-1064-QM	10-30mJ@10kHz	10-20 kHz	~150 @10 kHz	Acousto-optic
STC-HPL-1064-QS	1-15 mJ @10kHz	10 kHz	~7	Acousto-optic
STC-HPL-1064-QT	1-20 W	5-10 kHz	~70 @5 kHz	Acousto-optic
STC-LPS-1064-A	50-200 mJ	1-10 Hz	~10	Electro-optic
STC-LPS-1064-S	50-300 mJ	1-10 Hz	~10	Electro-optic
STC-LPS-1064-L	350-1000 mJ	1-10 Hz	~10	Electro-optic
STC-LPS-1064-M	1-10 J	1-20 Hz	~0.1-20 ms	Pulsed

4.5 1064nm Mode-locked & Picosecond Laser Series

Superior beam quality, best reliability, mode-locked & picosecond pulsed laser, pulsed duration could be less than 20ps. Housed in compact packages, are the perfect choice for design in and integration into OEM instrumentation and systems and also for end user applications in research and development.



Applications:

Raman spectroscopy; Marking, Carving; Material processing; Astronomy; Scientific research; Optical instrument

Mode-locked Type:

	Wavelength (nm)	Output power (mW)	Pulse duration (ps)	Rep. rate (MHz)	Operating mode	Transverse mode
STC-PS-RL-1064	1064	1-1000	~15 @10 kHz&1 W	1-10kHz	Mode-locked	TEM ₀₀
STC-PS-HR-1064	1064	1-10 W	~15@500kHz&10W	100-1000kHz	Mode-locked	TEM ₀₀
STC-PS-R-1064	1064	1-10 W	<20	48±1	Mode-locked	TEM ₀₀
STC-PS-Seed-1064	1064	1-300	<20	80±1	Mode-locked	TEM ₀₀
STC-Macro/ Micro-1064-P	1064	10 W	Macro 160 μs	Micro~100MHz	Mode-locked	TEM ₀₀

Fiber Laser Type:



	Wavelength (nm)	Output power (mW)	Pulse duration (ps)	Rep. rate (MHz)	Operating mode	Transverse mode
STC-FL-1064-PS	1064	1-2000	<10	20-80 (Fixed)	Mode-locked	TEM ₀₀
STC-FL-1064-Pico	1064	10-5000	100-900	0.1-20 (variable)	Pulsed	TEM ₀₀

Diode Pumped Laser Type:

	Wavelength (nm)	Output power (mW)	Pulse duration (ps)	Rep. rate (MHz)	Operating mode	Transverse mode
STC-DPS-1064-Pico	1064	5-30 W	<50 ps	0.1-10 MHz	Pulsed	TEM ₀₀

4.6 1064nm OEM Laser Module

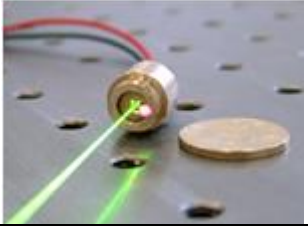
Infrared laser modules at 1064 nm are made features of ultra compact, low cost and easy operating, which are the perfect choice for design in and integration into OEM instrumentation and systems, and also for end user applications in scientific research, medical treatment and industrial development.

High Power OEM Laser		<ul style="list-style-type: none"> ● STC-OEM-S-1064/ 1~1500mW ● STC-OEM-N-1064/ 1500~5000mW ● STC-OEM-W-1064/ 6000~20000mW
Compact Laser Module		<ul style="list-style-type: none"> ● STC-PGL-I-R-1064/ 1~300mW ● STC-PGL-VI-1064/ 1~300mW ● STC-PGL-D12-1064/ 1~300mW ● STC-PGL-FS-1064/ 1~500mW ● STC-PGL-H1-1064/ 1~1000mW Beam divergence < 1.5 mrad
		<ul style="list-style-type: none"> ● STC-PGL-V-H-1064/ 1~1000mW

5. Lasers at Various Laser Wavelengths

5.1 CW DPSS SERIES:

Wavelength (nm) & Output power (mW)

Wavelength	261	303	320	335	349	355	360	425	430	457	473	480	484
SLM(single frequency)							50			2W	100		
Low noise							50			10W	500		
Basic version	5	5	20	20	30	10	200	10	100	10W	5W	30	20

Wavelength (nm)	491	501	515	522	523.5	526.5	532	540	543	550	552	555
SLM(single frequency)			20		100	100	10W		100			
Low noise			100	100	400	400	30W			100		
Basic version	400	200	500	100	800	1W	200W	500	1500	200	200	100

Wavelength (nm)	556	561	577	588	589	593.5	604	607	612	639	656.5	660	666
SLM(single frequency)	100	80	300	200	200			100		300	50	20	
Low noise	200	200	300	200	500	30				1W		400	
Basic version	2.5 W	2W	3.5 W	4.5 W	4.5 W	800	100	400	100	1W	1.2W	2W	200

Wavelength (nm)	671	689	698	721	914	946	1030	1040	1047	1053	1064	1105
SLM(single frequency)	2.5W		200	100	100	50	20		800	200	10W	
Low noise	5W		1W	100	800	800	600	100	1W	1.5W	20W	
Basic version	5W	200	1W	500	800	5W	600	100	8W	8W	500W	500

Wavelength (nm)	1122	1177	1313	1319	1342	1400-1800	1413	1444	1645	1910	1940	1990
SLM(single frequency)	80		500	50	5W							
Low noise	300		1W	1.5W	6W			400				
Basic version	1W	400	1W	150W	6W	2W	300	400	1W	13W	11W	11W

Wavelength (nm)	2096	2124	2600-4450	2796	2600	2800	3000	3200	3400	3600	4000	4200	4400
Basic version	20W	2.5W	1W	300	1W	1W	1W	1W	1W	1W	800	800	800

Notes: power can be any value between 0- maximum powers.

SLM: single longitudinal mode laser, spectral line width<0.00001 nm.

Low noise: Noise of amplitude (rms, 20Hz~20MHz) <1%. Multi-mode: multiple longitudinal mode.

CW DPSS UV Laser

Wavelength(nm)	261, 303, 320, 335, 349, 355, 360		
Laser version	SLM	Low noise	Basic version
261,303nm output power(mW)	/	/	5
320nm output power(mW)	/	/	20
335nm output power(mW)	/	/	10
349nm output power(mW)	/	/	30
355nm output power(mW)	/	/	10
360nm output power(mW)	50	50	200
Power stability, rms (8 h)	<3%, <5%	<1%, <2%, <3%	<1%, <2%, <3%, 10%
Output noise, rms (8 h)	<0.5%, <1%,	<0.5%, <1%	>10%

Transverse mode (Optional)	TEM ₀₀ , M ² <1.5	TEM ₀₀ , M ² <2	TEM ₀₀ , M ² <2
Linewidth	<10 ⁻⁵ nm	<0.2nm	<0.2nm
Coherent length	>50m	~10cm	~10cm
Polarization	>50:1, >100:1, optional Horizontal±5 degree (Vertical Optional)	>50:1, >100:1, optional Horizontal ±5 degree (Vertical Optional)	>50:1 Horizontal±5 degree (Vertical Optional)
Pointing stability	<0.05mrad	<0.05mrad	<0.1mrd
Beam diameter(1/e ²)	<1.5mm	~1.5mm	~1.0mm
Beam divergence	<1.2mrad	<1.0mrad	<1.0mrad

CW DPSS BLUE Laser

Wavelength(nm)	457, 473		
Laser version	SLM	Low noise	Basic version
457nm output power (mW)	5,10,50,100,....,2000	5, 10, 50, 100, ... , 100	5,10,50,100,....,10
473nm output power (mW)	5, 10, 20, ... , 100	5, 10, 50, ... , 500	5, 10, 50, ... , 50
Transverse mode(Optional)	TEM ₀₀ or Near TEM ₀₀ , M ² <1.2		
Power stability, rms (8 h)	Up to 1%		
Output noise, rms (8 h)	<0.5% (1Hz-20 MHz)	<1% (20Hz-20MHz)	<3% (1Hz-20MHz)
Longitudinal mode	Single	Multi	Multi
Linewidth	<10 ⁻⁵ nm	<0.2nm (<0.003nm for less than 400mW)	<0.3nm
Coherent length	>50 m	~10cm	~10cm
Polarization	Linear; Ratio >100:1; Horizontal optional for SLM laser		
Pointing stability	<0.05mrad for 473nm less than 500mW, and 457nm less than 1000mW		
Beam diameter(1/e ² , mm)	0.7, 2.0, 3.0, 4.0 optional		
Beam divergence (mrad)	1.2, 1.5, 2.0 depends on beam diameter		

CW DPSS BLUE Laser

Wavelength(nm)	425	430	480	484	491	
Output power (mW)	10	100	30	20	2	400
Transverse mode	Near TEM ₀₀					
Beam diameter(1/e ²)mm	~4	~5	~3	~4	~3	~4
Beam divergence (mrad)	< 3	< 2	< 1.5	< 3	< 1.5	< 3
Power stability, rms (8 h)	< 10%, <5%, (<3% available for individual wavelengths)					
Polarization	Linear; Ratio >100:1					

CW DPSS GREEN Laser

Wavelength(nm)	532		
Laser version	SLM	Low noise	Basic version
Output power(mW)	30,200,400,700,2W,10 W	300,400,1W,2.5W,5W, 20W, 30W	300, 1.5W, 2.5W, 5W, 20W, 30W, 80W
Transverse mode (Optional)	TEM ₀₀ or Near TEM ₀₀ , M ² <1.1		
Power stability, rms (8 h)	<1%		
Output noise, rms (8 h)	<0.5%(20Hz-20MHz) for low noise version		
Longitudinal mode	Single	Multi	Multi
Linewidth	<10 ⁻⁵ nm	0.2nm	
Coherent length	>50m	~10cm	
Polarization	Linear; Ratio>50:1, >100:1Horizontal±5 degree (Vertical Optional)		
Pointing stability	<0.05mrad for less than 400mW		
Beam diameter(1/e ²)mm	0.7, 1.2, 1.5, 2 optional		

Beam divergence(mrad)	1.2, 1.5, 2 depends on beam diameter
-----------------------	--------------------------------------

CW DPSS GREEN Laser

Wavelength (nm)	501	515	522	523.5	526.5	540	543	550	552	555
SLM version (mW)				100	100		100			
Low noise Version (mW)		100	100	400	400			100		
Basic version (mW)	200	500	100	800	1W	500	1.5W	200	200	100
Transverse mode (Optional)	TEM ₀₀ or Near TEM ₀₀ , M ² <1.2									
Power stability, rms (8 h)	Up to 1%									
Output noise, rms (8 h)	<0.5%(1Hz-20MHz) for low noise version									
Linewidth	<10 ⁻⁵ nm for SLM version, <0.2nm for basic version									
Coherent length	>50m for SLM version, >10cm for low noise version									
Polarization	Linear; Ratio>100:1Horizontal±5 degree (Vertical Optional)									
Pointing stability	<0.05mrad for less than 400mW									
Beam diameter(1/e ²) (mm)	0.7, 1.2, 1.5, 3 optional									
Beam divergence (mrad)	1, 1.5, 2 depends on beam diameter									

CW DPSS Yellow Orange Laser

Wavelength	556nm	561nm	577nm	588nm	589nm	593.5nm
SLM version (mW)	100	80	300	200	200	
Low Noise version (mW)	200	200	300	200	500	30
Basic version(mW)	2.5W	2W	3.5W	4.5W	4.5W	800
Transverse mode (Optional)	TEM ₀₀ or Near TEM ₀₀ , M ² <1.2					
Power stability, rms (8 h)	Up to 1%					
Output noise, rms (8 h)	<0.5%(1Hz-20MHz) for low noise version					
Linewidth	<10 ⁻⁵ nm for SLM version, <0.2nm for basic version					
Coherent length	>50m for SLM version, >10cm for low noise version					
Polarization	Linear; >100:1, Vertical±5 degree (Horizontal Optional)					
Pointing stability	<0.05mrad for less than 400mW					
Beam diameter(1/e ²)mm	0.7; 1.0; 1.5; 2.5 optional					
Beam divergence(mrad)	1.2; 1.5; 2 depends on beam diameter					

CW DPSS RED Laser

Wavelength(nm)	604, 607, 612, 639, 656.5, 660, 666, 671, 689, 698, 721		
Laser version	SLM	Low noise	Basic version
604nm output power(mW)			100
607nm output power(mW)	100	/	400
612nm output power(mW)			100
639nm output power(mW)	300	1W	1W
656.5nm output power(mW)	50	/	1.2W
660nm output power(mW)	20	400	2W
666nm output power(mW)	/	/	200
671nm output power(mW)	2.5W	5W	5W
689nm output power(mW)	/	/	200
698nm output power(mW)	200	1W	1W
721nm output power(mW)	100	100	500
Power stability, rms(8h)	<3%, <5%, <10%(721nm)	<3%, <5%, <10%(721nm)	<3%, <5%, <10%
Output noise, rms(8h)	<1%, <0.5%	<1%	< 1%
Longitudinal mode	Single	Multi	Multi
Linewidth	<0.00001nm,	<0.004nm	<0.2nm

	<0.0003nm(639nm)		
Coherent length	>50m for SLM version, >10cm for low noise version		
Polarization	>50:1,>100:1,optional Horizontal±5degree(Vertical Optional)	>50:1,>100:1,optional Horizontal±5degree(Vertical Optional)	> 50:1, > 100:1 optional Horizontal±5 degree (Vertical optional)
Pointing stability	<0.05mrad	<0.05mrad	<0.1mrad
Beam diameter(1/e ²)(mm)	1.0; 1.5; 2.0 optional		
Beam divergence(mrad)	1.0, 1.2; 1.5; 2 depends on beam diameter		

CW DPSS IR Laser

Wavelength(nm)	914	946	1030	1040	1047	1053	1064	1085	1105	1112	1122	1177
SLM Version(mW)	100	50	20		800	200	10W			20	80	
Low noise Version(mW)	800	800	600	100	1W	1500	20W	1W		100	300	
Basic Version (mW)	800	5W	600	100	8W	8W	500W	1W	500	500	1W	400
Transverse mode (Optional)	TEM ₀₀ or Near TEM ₀₀ , M ² <1.2											
Power stability, rms (8 h)	Up to 1%											
Output noise, rms (8 h)	<0.5%(20Hz-20MHz) for low noise version											
Linewidth	<10 ⁻⁵ nm for SLM version, <0.2nm for basic version											
Coherence length	>50m for SLM version, ~10cm or >1m for low noise version											
Polarization	Linear; 100:1											
Pointing stability	<0.05mrad for less than 100mW											
Beam diameter(1/e ² , mm)	0.7, 1.2, 1.5, 2 optional											
Beam divergence(mrad)	1.2, 1.5, 2 depends on beam diameter											

CW DPSS IR Laser

Wavelength(nm)	1313	1319	1342	1413	1444	1645	1910	1940	1990	2096	2124	2796
SLM Version(mW)	500	50	5W									
Low noise Version(mW)	1W	1.5W	6W		400							
Basic Version (mW)	1W	150W	6W	300	400	1W	13W	11W	11W	20W	2.5W	300
Transverse mode (Optional)	TEM ₀₀ or Near TEM ₀₀ , M ² <1.2											
Power stability, rms (8 h)	Up to 1%											
Output noise, rms (8 h)	<0.5%(20Hz-20MHz) for low noise version											
Linewidth	<10 ⁻⁵ nm for SLM version, <0.2nm for basic version											
Coherence length	>50m for SLM version, ~10cm or >1m for low noise version											
Polarization	Linear; 100:1											
Pointing stability	<0.05mrad for less than 100mW											
Beam diameter(1/e ² , mm)	0.7,1.2,1.5,2 optional											
Beam divergence(mrad)	1.2, 1.5, 2 depends on beam diameter											

CW DPSS OPO IR Laser

Wavelength (nm)	1400-1800	2600-4400	1400-1800	2600-4450
Laser version	Single wavelength output in this range		Wavelength tunable, range up to 3500	
Output power (mW)	Up to 2W	Up to 1W	Up to 2W	Up to 1W
Transverse mode	Near TEM ₀₀			
Power stability, rms (8 h)	< 5%			
Linewidth	< 2nm			
Beam diameter (1/e ² , mm)	<10			
Beam divergence (mrad)	<8 or <10			

5.2 Direct Diode Series

5.2.1 Wavelength & Output power (mW)

Wavelength	375	395	397	400	405	410	415	420	442	445	447
Narrow Linewidth	20			50	150	50	50		200	30	30

Max power	800	100	100	300	10W	300	350	350	8W	20W	20W
-----------	-----	-----	-----	-----	-----	-----	-----	-----	----	-----	-----

Wavelength (nm)	450	454	460	462	465	470	488	505	510	514.5	520
Narrow Linewidth	30	30	100				70			40	10
Max power	150W	16W	16W	16W	16W	16W	200	80	30	50	10W

Wavelength (nm)	622	627	633	635	637	640	642	650	655	660	665
Narrow Linewidth			80	30	80	30	30	30	30	120	
Max power	50	100	500	8W	4W	4W	4W	4.5W	4.5W	4.5W	2W

Wavelength (nm)	685	689	690	698	705	730	750	760	785	793	800	808
Narrow Linewidth				10	450				450			450
Max power	800	20	1300	25	1.5W	5W	5W	5W	2.5W	4W	2.5W	10W

Wavelength (nm)	825	830	845	852	860	880	885	905	915	940	975	980
Narrow Linewidth		100		450					30	30	450	450
Max power	2.5W	2W	30	1.5W	4W	1.8W	1.5W	400	8W	4.5W	10W	10W

Wavelength (nm)	1060	1120	1310	1450	1470	1532	1550	1850	1870	1900	2200
Narrow Linewidth	40						15				
Max power	2.5w	5W	800	1W	3.5W	3.5W	3.5W	1W	800	600	400

5.2.2. CW Diode UV and Violet-Blue Lasers

Wavelengths(nm)	375	395	397	400	405	410	415	420	442	445	447	450	454
Long Coherent Length (mw)				50	50	50	50		30	30	30	30	
Narrow Line width (mw)	20			50	150	50	50		30	200	30	30	30
Low noise (mw)	400	100	100	300	1W	350	350	350	3.5W	3.5W	3.5W	3.5W	800
Single mode(mw)	50				30				80	80	80	80	80
Max. power (w)	0.8	100	100	100	10W	350	350	350	8W	20W	20W	150W	16W
Beam divergence, full angle	0.5 to 2.3mrad depending on output power and wavelength												
Transverse mode	TEM ₀₀ , Near TEM ₀₀ or Multi-mode depending on output power and wavelength												
Power stability, rms(4 h)	<1%, <2%, <3%,												
Noise of amplitude	1%, 0.5% (rms, 20Hz~20MHz)												
Spectral linewidth (nm)	<0.06nm,/0.03nm optional (for Narrow Line width laser)												
Coherent length (m)	>1m(for Long Coherent Length laser)												
Polarization ratio	>50:1, >100:1 and Horizontal+Vertical depending on output power and wavelength												

5.2.3 CW Diode Blue and Green Lasers

Wavelengths(nm)	460	462	465	470	488	505	510	514.5	520
Long Coherent Length (mw)					70			40	10
Narrow Line width (mw)	100				70			40	10
Low noise (mw)	2000	2000	2000	2000	150	80	30	50	800
Single mode(mw)					150	80	30	50	50
Max. power (w)	16W	16W	16W	16W	0.2				10W
Beam divergence, full angle(mrad)	0.5 to 2.3mrad depending on output power and wavelength								
Transverse mode	TEM ₀₀ , Near TEM ₀₀ or Multi-mode depending on output power and wavelength								
Power stability, rms(4 h)	<1%, <2%, <3%,								
Noise of amplitude(rms, 20Hz~20MHz)	<0.5%, <1%(for Low Noise laser); <3%								
Spectral linewidth (nm)	<0.06nm,/0.03nm optional (for Narrow Line width laser)								
Coherent length (m)	>1m(for Long Coherent Length laser)								
Polarization ratio	>50:1, >100:1 and Horizontal+Vertical depending on output power and wavelength								

5.2.4 CW Diode Red Lasers

Wavelengths(nm)	622	627	633	635	637	640	642	650	655
-----------------	-----	-----	-----	-----	-----	-----	-----	-----	-----

Long Coherent Length (mw)				30	80	30	30		
Narrow Line width (mw)			80	30	80	30	30	30	30
Low noise (mw)			500	500	200	200	200	1W	1w
Single mode (mw)			80	200	200	200	200	180	180
Round beam (mw)				150				200	200
Max. power (w)	50	100	500	8W	4W	4W	4W	4.5W	4.5W
Beam divergence, full angle (mrad)	1 to 3mrad depending on output power and wavelength								
Transverse mode	TEM ₀₀ , Near TEM ₀₀ or Multi-mode depending on output power and wavelength								
Power stability, rms(4 h)	<1%, <2%, <3%,								
Noise of amplitude (rms, 20Hz~20MHz)	<0.5%, <1%(for Low Noise laser); <3%(basic version)								
Spectral linewidth (nm)	<0.06nm,/0.03nm optional (for Narrow Line width laser)								
Coherent length (m)	>1m(for Long Coherent Length laser)								
Polarization ratio	>50:1, >100:1 and Horizontal+Vertical depending on output power and wavelength								

Wavelengths(nm)	660	665	680	685	690	705	730	750	760
Narrow Line width (mw)	120				450	10	450		
Low noise (mw)	1000		800	20	1300	25	1500	2W	5W
Single mode (mw)	180			20		25	30		
Round beam (mw)	200		200		200				
Max. power (w)	4.5W	2W	800		1300		1500	5W	5W
Beam divergence, full angle (mrad)	1 to 3mrad depending on output power and wavelength								
Transverse mode	TEM ₀₀ , Near TEM ₀₀ or Multi-mode depending on output power and wavelength								
Power stability, rms(4 h)	<1%, <2%, <3%,								
Noise of amplitude (rms, 20Hz~20MHz)	<0.5%; <1%(for Low Noise laser); <3%(basic version)								
Spectral linewidth (nm)	<0.06nm,/0.03nm optional (for Narrow Line width laser)								
Coherent length (m)	>1m(for Long Coherent Length laser)								
Polarization ratio	>50:1, >100:1 and Horizontal+Vertical depending on output power and wavelength								

5.2.5 CW Diode Infrared Laser

Wavelengths(nm)	785	793	800	808	825	830	845	852	860
Narrow Linewidth (mw)	450			450		100		450	
Low noise (mw)	2.5w	2.5w		2.5w		2w	30	1.5w	1w
Single mode (mw)	100			100		120	30	150	
Round Beam (mw)	300		500	500		500		500	
Max power (mw)	2.5w	4w	2.5w	10w	2.5w	2w		1.5w	4w
Beam divergence, full angle	1 to 3mrad depending on output power and wavelength								
Transverse mode	TEM ₀₀ , Near TEM ₀₀ , Round or Multi-mode depending on output power and wavelength								
Power stability, rms(4h)	<1%, <2%, <3%,								
Noise of amplitude	<0.5%; <1%(for Low Noise laser); <3%(basic version)								
Spectral linewidth (nm)	<0.06nm,/0.03nm optional (for Narrow Line width laser)								
Polarization ratio	>50:1, >100:1 and Horizontal+Vertical depending on output power and wavelength								

Wavelengths(nm)	880	885	905	915	940	975	980	1060	1120
Narrow Line width(mw)				30	30	450	450	40	
Low noise (mw)	1.8w	1.5w	400	1.5w	250	2w	2w	1.5w	1w
Single mode (mw)			70	270	250		200	200	
Round Beam (mw)		400		400	350	500	500		
Max power (mw)	1.8w	1.5w	400	8w	4.5w	10w	10w	2.5w	5w
Beam divergence, full angle	1 to 3mrad depending on output power and wavelength								
Transverse mode	TEM ₀₀ , Near TEM ₀₀ or Multi-mode depending on output power and wavelength								
Power stability, rms(4 h)	<1%, <2%, <3%,								
Noise of amplitude	<0.5%; <1%(for Low Noise laser); <3%(basic version)								
Spectral linewidth (nm)	<0.06nm,/0.03nm optional (for Narrow Line width laser)								
Polarization ratio	>50:1, >100:1 and Horizontal+Vertical depending on output power and wavelength								

Wavelengths(nm)	1310	1450	1470	1532	1550	1850	1870	1900	2200
Narrow Linewidth (mw)					15				
Low noise (mw)	800	1w	500		1w				
Single mode (mw)	10	20	20	20	30				
Round Beam (mw)		200	200		200				
Max power (mw)	800	1w	3.5w	3.5w	3.5w	1w	800	600	400
Beam divergence, full angle	1 to 3mrad depending on output power and wavelength								
Transverse mode	TEM ₀₀ , Near TEM ₀₀ or Multi-mode depending on output power and wavelength								
Power stability, rms(4 h)	<1%, <2%, <3%,								
Noise of amplitude	<0.5%; <1%(for Low Noise laser); <3%(basic version)								
Spectral linewidth (nm)	<0.06nm,/0.03nm optional (for Narrow Line width laser)								
Polarization ratio	>50:1, >100:1 and Horizontal+Vertical depending on output power and wavelength								

5.2.6 Fiber Coupled High Power Diode Laser System

Fiber Coupling Laser System have integrated laser diode, fiber coupling optics, laser power supply, LD current and temperature control in ONE box. Its compact dimension and convenient functions, such as power adjustment, temperature control, LED display etc, make it very suitable for pumping, scientific research, industrial and medical applications.



STC-FC-W-xxxA



STC-FC-W-xxxB/H

High Power Fiber Coupled Diode Laser System at 793-980nm (STC-FC-W-xxxA)

Model	STC-FC-W-xxxA (x stands for wavelength)									
Available Wavelengths (nm)	793	808	810	878.6	880/ 885	915	938	940	976	980
Central Wavelengths Tolerance (nm)	±3	±3	±10	±0.5	±3	±5	±3	±10	±3	±3/ ±10
Available Power (W)	40	10, 20, 30, 40			20, 40	30	25, 30			
Red Pilot Light (P)	Available on request									
Fiber Core Diameter (um)	400									
Fiber NA	0.22									
Fiber Connector	SMA905									
Fiber Length (m)	2									
Output Power	0-100%, adjustable by knob									
Operating Mode	CW, TTL or Analog on request									
Dimensions (mm ³)	292 (L) × 322 (W) × 156 (H)									

High Power Fiber Coupled Diode Laser System at 1064-1908nm (STC-FC-W-xxxB)

Model	STC-FC-W-xxxB (x stands for wavelength)											
Available Wavelengths (nm)	1064	1208	1275	1320	1380	1470	1532	1550	1600	1710	1870	1908
Central Wavelengths Tolerance (nm)	±20	±20	±20			±20	±3/±20	±20	±20	±20		±3/ ±10

Available Power (W)	30	12	15	10, 15	10, 15	10, 15	10, 15	6	6
Red Pilot Light (P)	Available on request								
Fiber Core Diameter (μm)	400								
Fiber NA	0.22								
Fiber Connector	SMA905								
Fiber Length (m)	2								
Output Power	0-100%, adjustable by knob								
Operating Mode	CW, TTL or Analog on request								
Dimension (mm ³)	406 (L) × 370 (W) × 186 (H)								

Super High Power Fiber Coupled Diode Laser System (STC-FC-W-xxxH)

Model	STC-FC-W-792H	STC-FC-W-808H	STC-FC-W-880H	STC-FC-W-915H	STC-FC-W-940H	STC-FC-W-980H
Available Wavelengths (nm)	792	808	880	915	940	976/ 980
Central Wavelengths Tolerance (nm)	±3	±3/±10	±3	±5	±3	±3/±10
Available Power (W)	50-100	50-100	50-100	50-100	50-100	50-100
Red Pilot Light	Available on request					
Fiber Core Diameter (μm)	400			400/200		
Fiber NA	0.22					
Fiber Connector (un-detachable)	SMA905					
Fiber Length (m)	2					
Output Power	0-100%, adjustable by knob					
Operating Mode	CW/ Pulse					
LED Display	Diode current, temperature, frequency and pulse					
LD Temperature Control Range (°C)	18~45, adjustable by knob					
Temperature Stability (°C)	±0.1					
Expected Lifetime (hours)	10000					
Input Power	200-240VAC					
Power Consumption (KVA)	<0.5					
Operating Temperature (°C)	10~30					
Weight (kg)	<15					
Cooling Way	by air					
Warranty time	1 year					
Dimension (mm ³)	406 (L) × 370 (W) × 186 (H)					
Remark	The laser is offered with current and temperature display of laser diode (LD), power adjustable knob, controllable temperature of LD, temperature and current protection.					

5.3 Q-switched & Pulsed DPSS SERIES

5.3.1 Wavelength & Max. single pulse energy (μJ)

Wavelength (nm)	244	257	261	266	289	295	335	349	351	355	440	457	473
Passively Q-switched		4	4	30				10	4	80			
Acousto-optics Q-switched	3.75			20	5	4			15	250	²⁰ ₀	50	50
Electro-optics Q-switched				5mJ			10			200mJ			

Wavelength (nm)	488	523.5	526.5	532	556	589	656.5	660	671	786	914	946
Passively Q-switched		60	60	125			2	5		20		

Acousto-optics Q-switched	70	433	20	13mJ	5mJ	12.5mJ		10mJ	350		100	150
Electro-optics Q-switched				450mJ					50			

Wavelength (nm)	1030	1047	1053	1064	1313	1319	1342	1535	1573	2096	2600
Passively Q-switched	150	150	50	300	20	15			50		20
Acousto-optics Q-switched	130	2mJ	250	30mJ		10mJ	500		30	1500	16.7
Electro-optics Q-switched				1J			200	100	8mJ		
Pulsed				10J							

Wavelength (nm)	2800	2940	3000	3200	3400	3600	3800	4000	4200	4400	4500	4600	4800
Passively Q-switched	20	200mJ	20	20	20	20	20	20	20	20			
Acousto-optics Q-switched	16.7		16.7	13	16.7	16.7	16.7	16.7	16.7	16.7	900	200	200

5.3.2 Q-Switched UV Lasers

Passively Q-switched

Wavelength(nm)	257	261	266	349	351	355
Max average power(mW)	15	10	600	30	10	2000
Single pulse energy(μ J)	4	4	30	10	4	80
Pulse width(ns)	10	4	5	4	4	5
Repetition Rate	10kHz-15kHz	0.1Hz-1kHz	1kHz-4kHz	0.1Hz-1kHz	0.1Hz-1kHz	1kHz-4kHz
Transverse mode	Near TEM ₀₀	Near TEM ₀₀	Near TEM ₀₀	Near TEM ₀₀	Near TEM ₀₀	Near TEM ₀₀
Power stability, rms (8h)	<10%	<5%, <10%	<5%, <10%	<5%, <10%	<5%, <10%	<5%, <10%
Polarization	>100:1	>50:1	>100:1	>50:1	>50:1	>100:1
Pointing stability	< 1mrad	< 1mrad	< 1mrad	< 0.05mrad	< 0.05mrad	< 0.05mrad
Beam diameter(mm)	0.5*2	2	4	2	2	4
Beam divergence(mrad)	< 2.0	< 2.5	< 2.0	< 1.5	<1.5	<2

Acousto-optics Q-switched

Wavelength(nm)	244	266	289	295	351	355
Max average power(mW)	15@4kHz	200@10kHz	50	1-80@20kHz	15@1kHz	3W@20kHz
Single pulse energy(μ J)	0.1-3.75	20@10kHz	5	0.1-4	15@1kHz	150@20kHz
Pulse width(ns)	<30@4kHz&15mW	10-15@<10kHz	10+/-2	~30@20kHz&80mW	6-10@<10kHz	15@20kHz
Repetition Rate	4kHz	1-50kHz	10kHz	20kHz	0.1-15kHz	10-100kHz
Transverse mode	Near TEM ₀₀					
Power stability, rms (4h)	< 5%, < 10%	< 5%, < 10%	< 3%, < 5%	< 5%, < 10%	< 3%, < 5%, < 10%	< 3%, < 5%, < 10%
Polarization	>100:1					
Beam diameter(mm)	~2.0	~2.0	1.5*3	~2.0	~0.3	~1.5
Beam divergence(mrad)	<3	<3.5	<1.0	<3	<5.0	<1.0

Electro-optics Q-switched

Wavelength(nm)	266	335	355
Single pulse energy(mJ)	5	10	10
Pulse width(ns)	<10	~4	<10
Repetition Rate	1~100Hz (adjustable)	10kHz	1~100Hz (adjustable)
Energy stability	<4%	<3%	<4%
Beam diameter(mm)	~2.5	~2.5	~3
Beam divergence(mrad)	<3	<3	<3

5.3.3 Q-Switched Blue Lasers

Wavelength(nm)	440	457	473	488
Operating Mode	Acousto-Optics Q-switched			

Max average power at typical rep rate(mW)	2W@10kHz	500@20kHz	500@10kHz	300@4kHz
Single pulse energy(μ J)	200@10kHz	50@1kHz	50@1kHz	75@4kHz
Pulse width(ns)	100@10kHz	300@10kHz	200@10kHz	30@4kHz
Repetition Rate	10kHz	1-50kHz	1-200kHz	4kHz
Transverse beam mode	TEM ₀₀ , M ² < 1.5			
Power stability, rms (8h)	< 3%, < 5%			
Polarization	Linear, 100:1			
Beam diameter(1/e ²)mm	6	1	1	5
Beam divergence(mrad)	3.5	2.5	2.5	5
Cooling Method	Water cooled	Air cooled	Air cooled	Water cooled

5.3.4 Q-Switched Green Lasers

Wavelength(nm)	523.5	526.5	523.5	526.5	556
Operating mode	Passively Q-switched		Acousto-optics Q-switched		
Max average power(mW)	150		1300@3kHz	50	5 @10kHz&50W
Max. single pulse energy(μ J)	60		433@3kHz	20 μ J@1kHz	5 @10kHz&50W
Peak power	2.5W-15W		43kW@3kHz	5W	50kW @10kHz&50W
Pulse width	~4ns		~10ns	5~10ns@<10kHz	200ns @10kHz
Repetition Rate	0.1-3 kHz		3-10kHz	0.1-50kHz	10-20kHz
Transverse mode	TEM ₀₀ , M ² < 1.5				
Power stability, rms (8h)	< 3%, < 5%				
Beam diameter(1/e ²) mm	~1.2, 3.0 depends on single pulse energy		2	<1.2, < 0.3 depends on single pulse energy	≥ 12 , ≥ 15 depends on single pulse energy
Beam divergence (mrad)	< 1.5, < 2.0 depends on beam diameter at the aperture		<2	< 1.5, < 5 depends on beam diameter at the aperture	< 3.5

Wavelength(nm)	532			
Operating mode	Passively Q-switched		Acousto-optics Q-switched	
Max average power	1500mW	50mW	8W@25kHz @300 μ J	200W
Max. single pulse energy	125 μ J	5mJ	600 μ J	13mJ
Peak power(kW)	10-25	/	20 @25kHz @300 μ J	130 @15kHz @13mJ
Pulse width	1.3, 5, 10ns optional	< 10ns	5-15ns	100ns (5ns optional)
Repetition Rate	1-30kHz	1-10Hz	1Hz-200kHz	10-20kHz
Transverse mode	Near TEM ₀₀ , M ² < 1.5	/	M ² < 1.5 for less than 100 μ J	/
Power stability, rms (8h)	< 3%, < 5%	< 5%	< 1%, < 3%, < 5%	< 3%, < 5%
Beam diameter(1/e ²) mm	0.8, 1.0, 1.2 depends on single pulse energy	~3	0.3, 1.2 for less than 100 μ J; 1.0, 2.0, 2.5 optional	≥ 6 , ≥ 9 , ≥ 12 , ≥ 15 depends on single pulse energy
Beam divergence (mrad)	1.5, 2.0, 3.0 depends on beam diameter at the aperture		<1.5, 2.0, 2.5 optional	<3.5

Wavelength(nm)	532	
Operating mode	Electro-optics Q-switched	
Pumped source	Diode pumped	Lamp pumped
Max. single pulse energy	20mJ	450mJ
Pulse width	10, 12ns	8, 10, 12ns depends on single pulse energy
Repetition Rate	1-10/ 20/ 100Hz (1000Hz optional)	1-10Hz
Energy stability, rms (8h)	< 3%	< 4%
Beam diameter(1/e ²) mm	1.5, 2, 3, 4 depends on single pulse energy	< 6, 7, 8, 9 depends on single pulse energy
Beam divergence (mrad)	1.0, 2.0, 3.0 depends on beam diameter at the aperture	1.0, 1.5, 3.0 depends on beam diameter at the aperture

5.3.5 Q-Switched Yellow Lasers

Wavelength(nm)	589	
Operating mode	Acousto-optics Q-switched	
Average power	1-5W (Nonadjustable)	1-50W (Nonadjustable)

Single pulse energy	1mJ @5W	12.5mJ@4kHz
Peak power	8kW	80kW@4kHz
Pulse width	100-150@5W	100-150
Spectral linewidth	3GHz	/
Repetition Rate	5kHz	4 or 14kHz optional
Power stability, rms (8h)	< 3%, < 5%	
Beam diameter(1/e ²) mm	~18	
Beam divergence (mrad)	< 3.0	
Cooling method	Water cooled	

5.3.6 Q-Switched Red Lasers

Wavelength(nm)	656.5	660	786
Operate Mode	Passively Q-switched		
Max average power	4mW	10mW	/
Single pulse energy	2uJ	5uJ	20uJ
Pulse width	15ns	15ns	7ns
Repetition Rate	1Hz-2kHz	1Hz-2kHz	10Hz
Transverse mode	TEM ₀₀	TEM ₀₀	Near TEM ₀₀
Power stability, rms (8h)	< 1%, < 3%, < 5%	< 1%, < 3%, < 5%	< 3%, < 5%
Beam diameter(1/e ²)mm	1.2	1.2	2.5
Beam divergence(mrad)	1.5	1.5	2.5

Wavelength(nm)	660	671	
Operate Mode	Acousto-optics Q-switched	Acousto-optics Q-switched	Electro-optic Q-switched
Max average power	100W @10kHz	4W @20kHz	500mW (500mW@10kHz)
Single pulse energy	10mJ @10kHz &100W	350uJ@10kHz	50(50uJ @10kHz)
Pulse width	~150ns @10kHz &100W	25 @10kHz	~4 @10kHz
Repetition Rate	10-20kHz	1-100kHz	10kHz
Transverse mode	TEM ₀₀	Near TEM ₀₀	Near TEM ₀₀
Power stability, rms (8h)	< 3%, < 5%	< 5%	< 3%, < 5%
Beam diameter(1/e ²)mm	≥ 15	~1.0	~1.5
Beam divergence(mrad)	< 3.5	< 2.5mrad	<3

5.3.7 Q-Switched IR Lasers

Acousto-optics Q-switched

Wavelength(nm)	914	946	1030	1047	1053	1319	1342	1573
Max average power(W)	1.5@30kHz	1.5@10kHz	1.3@10kHz	3@3kHz	2	100	4@10kHz	1@30kHz
Single pulse energy(μJ)	100@1kHz	150@10kHz	130@10kHz	1000@3kHz	250@1kHz	10mJ@10kHz	500@1kHz	30@30kHz
Pulse width(ns)	80@1kHz	90@10kHz	50@10kHz	10@3kHz	11@10kHz	250@10kHz	40@10kHz	10@30kHz
Repetition Rate(kHz)	1-50	1-50	1-10	1-10	0.1-80	10-20	1-50	1-50
Power stability, rms (8h)	< 1%	< 1%	<3%	<3%	<3%	<3%	< 1%	<3%
Beam diameter(1/e ²)mm	2.5	2.5	4	2	0.4	15	2	4
Beam divergence(mrad)	2	2	2	2	5	3.5	2	2

Passively Q-Switched

Wavelength(nm)	1047	1053	1064	1313	1319	3800
Max average power(mW)	3000	450	3000	100	150	300mW
Single pulse energy	2000uJ	50uJ	200uJ	20uJ	15uJ	30uJ
Pulse width	~10ns	~10ns	<2ns/3-5ns	~18ns	~15ns	5-10ns
External trigger repetition Rate	1-10kHz	1-5kHz	1-10kHz	1Hz-5kHz	1-4kHz	5kHz-15kHz
Transverse Mode	TEM ₀₀					TEM ₀₀
Power stability, rms (8h)	< 3%	<3%	<1%	<1%	<3%	< 5%
Beam diameter(mm)	2	3	2	3	2	3
Beam divergence(mrad)	< 2	< 2	< 1.5	2	< 1.5	1.5

Acousto-optics Q-switched

Wavelength (nm)	2096	3800	2600 /2800 /3000/	3900-4500	4000 /4200 /4400 /4600
-----------------	------	------	-------------------	-----------	------------------------

10 Bukit Batock Crescent #07-02 The Spire Singapore 658079 Tel: 6316 7112 Fax: 63167113

<http://www.SintecOptronics.com> <http://www.sintec.sg> sales@sintec.sg sales@SintecOptronics.com

			3200 /3400 /3600		4800
Max average power	5W	9W	1-500mW	1-9W	1-2W
Peak power			750@30kHz&500mW	45kW @10kHz &9W	10kW @10kHz &2W
Pulse width	20-40ns	~20ns@10kHz&9W	~22ns@30kHz&500mW	20ns@10kHz&9W	20ns
Repetition Rate	< 10 kHz	10kHz	30kHz	10kHz	10kHz
Power stability, rms (8h)	< 3%	<5%	<5%	< 5%	< 5%
Beam diameter(1/e2) mm	~3	<6	~11	< 6	< 6
Beam divergence (mrad)	< 3	<12	<5	< 12	< 12

Acousto-optics Q-switched and Electro-optics Q-switched

Wavelength(nm)	1064				1573	
Operate Mode (Q-switched)	Acousto-optics		Electro-optics		Acousto-optics	Electro-optics
Max average power(W)	20@20kHz	150@10kHz	/		1@30kHz	
Max. single pulse energy	1000uJ@20kHz	15mJ@10kHz	100mJ	1000mJ	30uJ	8mJ
Peak power	1-76kW	2MW	/		30kW	
Pulse width(ns)	13	~7	~10	<8	~10	<10
Repetition Rate	1-20kHz	10kHz	20Hz	1-10Hz	1-200kHz	1-20Hz
Transverse mode	Near TEM ₀₀ , M ² <2	/	/		/	
Cooling Method	Water	Water	Air	Water	Air	Water
Power/Energy stability, rms(8h)	<1%	<3%	<3%		<5%	<5%
Beam diameter(1/e2) mm	0.4, 1, 1.5, 2 depends on different power level	6, 12, 19 depends on different power level	3, 4, 5 depends on different energy levels	6, 7, 8, 9 depends on different energy levels	~4	3,4 depends on different energy level
Beam divergence(mrad)	2,3,5 depends on beam diameter at the aperture	<3	1, 2, 3 depends on different energy		<2	<8

Narrow Linewidth Diode Lasers

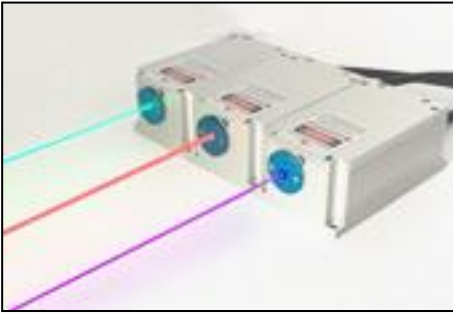

STC-MDL-E series lasers, with the characteristic of ultra narrow spectral linewidth $<0.03\text{nm}$, are ideal for application in DNA sequencing, flow cytometry, digital imaging, analytical chemistry, particle measurement, confocal microscopy, Raman spectroscopy and many other fields. Housed in ultra compact package, these lasers are the perfect choice for OEM instrumentation, systems design and integration, and also for end user applications in research and development.

Wavelength (nm)	Output power (mW)	Wavelength (nm)	Output power (mW)
375	1~20	637	1~80
400	1~50	640	1~30
405	1~150	642	1~30
410	1~150	650	1~30
415	1~150	655	1~30
442	1~30	660	1~120
445	1~30	705	1~10
447	1~30	730	1~10
450	1~30	785	1~20
454	1~30	808	1~20
457	1~30	830	1~30
460	1~100	915	1~30
488	1~70	940	1~30
514.5	1~40	975	1~30
520	1~10	980	1~30
633	1~80	1060	1~40
635	1~30		

Ordering Information: STC-MDL-E-xxxx-yyy-zzz, where xxxx means wavelength in nm, yyy means output power in mW, zzz means power stability in 1%, 2% or 3%.

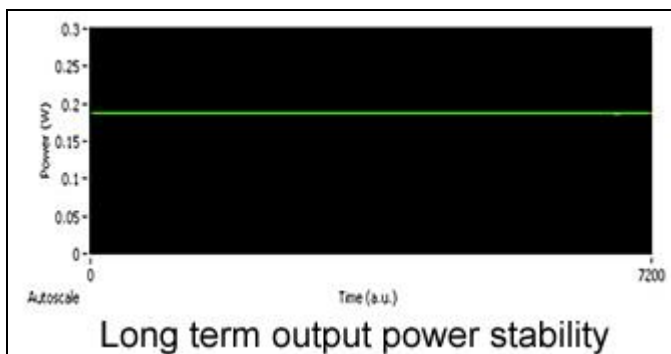

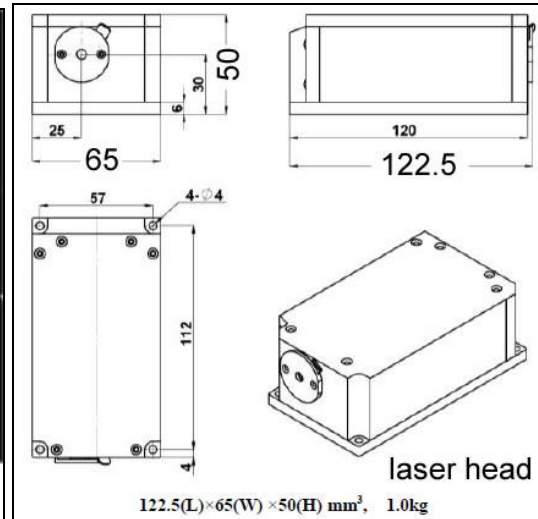
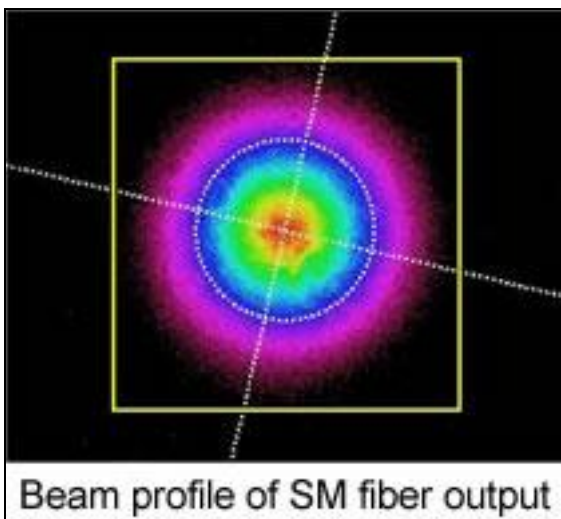
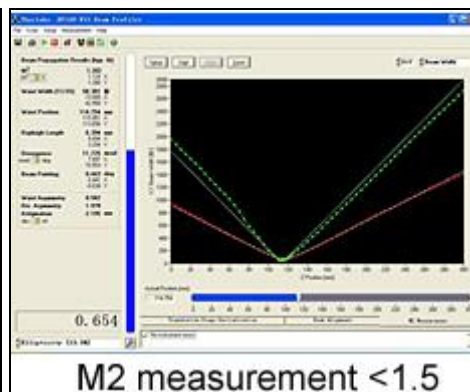
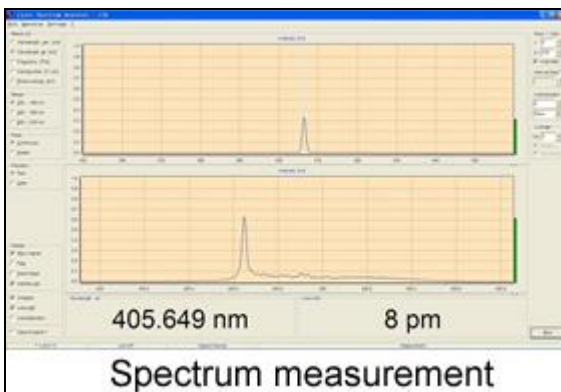
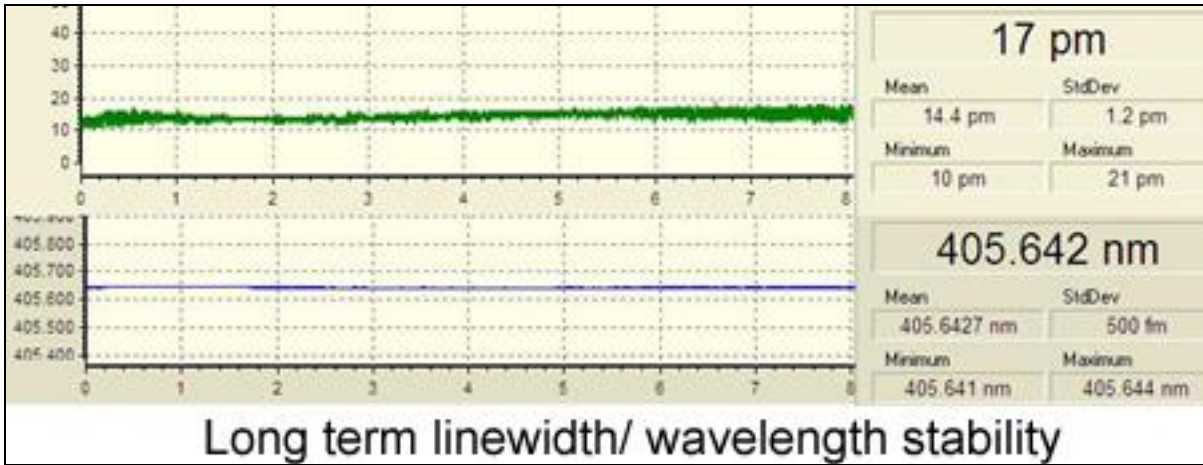

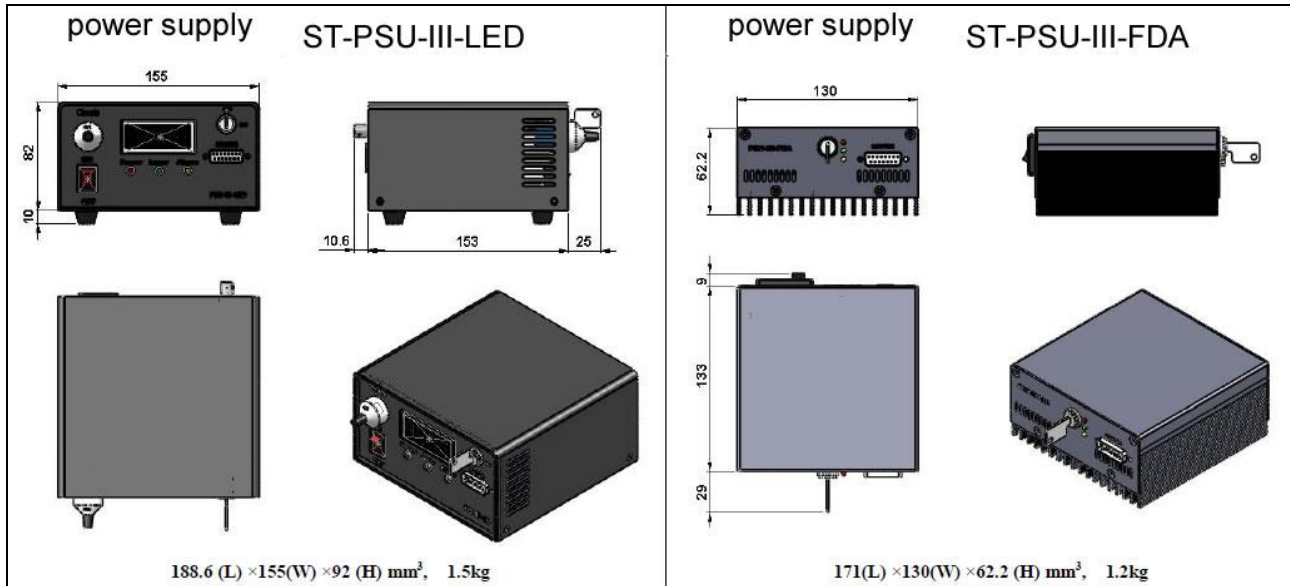

375nm Narrow Linewidth Diode Lasers

Central wavelength (nm)	375±0.5
Operating mode	CW
Output power (mW)	>1, 2, 3, ...,20
Power stability (rms, over 4 hours)	<1%, <2%, <3%
Transverse mode	Near TEM00
Spectral linewidth (nm)	<0.06 (<0.03, optional)
M2 factor	<1.5
Beam diameter at the aperture (1/e ² ,mm)	~3.0
Beam divergence, full angle (mrad)	<0.5
Polarization ratio	>10:1 (>50:1, optional) Horizontal ±5 degree (Vertical Optional)
Warm-up time (minutes)	<5
Beam height from base plate (mm)	30
Operating temperature (°C)	20~30
Power supply (85-264VAC)	ST-PSU-III-FDA
Expected lifetime (hours)	10000
Warranty	1 year
Laser head dimension & weight	122.5x65x50mm / 1kg
Power supply dimension & weight	170x130x62.2mm / 1.2kg

400nm Narrow Linewidth Diode Lasers

Central wavelength (nm)	400±1
Operating mode	CW
Output power (mW)	>1, 10, 20,...,50
Power stability (rms, over 4 hours)	<1%, <2%, <3%
Transverse mode	Near TEM00
Spectral linewidth (nm)	<0.06 (<0.03, optional)
Beam diameter at the aperture (1/e ² ,mm)	~1.3
Beam divergence, full angle (mrad)	<1.5
Polarization ratio	>50:1 (>100:1, optional) Horizontal±5 degree (Vertical Optional)
Warm-up time (minutes)	<5
Beam height from base plate (mm)	30
Operating temperature (°C)	20~30
Power supply (85-264VAC)	ST-PSU-III-LED/ ST-PSU-III-FDA
Expected lifetime (hours)	10000
Warranty	1 year
Laser head dimension & weight	122.5x65x50mm / 1kg
Power supply dimension & weight	188.6x155x92mm / 1.5kg or

	170x130x62.2mm / 1.2kg
--	------------------------

405nm Narrow Linewidth Diode Lasers

Central wavelength (nm)	405±1
Operating mode	CW
Output power (mW)	>1, 10, 50, ..., 150
Power stability (rms, over 4 hours)	<1%, <2%, <3%
Transverse mode	Near TEM00
Spectral linewidth (nm)	<0.06 (<0.03, optional)
Beam diameter at the aperture (1/e ² ,mm)	~1.3
Beam divergence, full angle (mrad)	<1.5
Polarization ratio	>50:1 (>100:1, optional) Horizontal±5 degree (Vertical Optional)
Warm-up time (minutes)	<5
Beam height from base plate (mm)	30
Operating temperature (°C)	20~30
Power supply (85-264VAC)	ST-PSU-III-LED/ ST-PSU-III-FDA
Expected lifetime (hours)	10000
Warranty	1 year
Laser head dimension & weight	122.5x65x50mm / 1kg
Power supply dimension & weight	188.6x155x92mm / 1.5kg or 170x130x62.2mm / 1.2kg

454nm Narrow Linewidth Diode Lasers

Central wavelength (nm)	454±5
Operating mode	CW
Output power (mW)	>1, 2, 3, ..., 30
Power stability (rms, over 4 hours)	<1%, <2%, <3%
Transverse mode	Near TEM00
Spectral linewidth (nm)	<0.06 (<0.03, optional)
M2 factor	<1.5
Beam diameter at the aperture (1/e ² ,mm)	~3.5
Beam divergence, full angle (mrad)	<1.0
Polarization ratio	>50:1 (>100:1, optional) Horizontal±5 degree (Vertical Optional)
Warm-up time (minutes)	<5
Beam height from base plate (mm)	30
Operating temperature (°C)	20~30
Power supply (85-264VAC)	ST-PSU-III-FDA
Expected lifetime (hours)	10000
Warranty	1 year
Laser head dimension & weight	122.5x65x50mm / 1kg
Power supply dimension & weight	170x130x62.2mm / 1.2kg

488nm Narrow Linewidth Diode Lasers

Central wavelength (nm)	488±0.5
Operating mode	CW
Output power (mW)	>1, 5, 10, ..., 30, 40, ..., 70
Power stability (rms, over 4 hours)	<1%, <2%, <3%
Transverse mode	Near TEM00
Spectral linewidth (nm)	<0.06 (<0.03, optional)
M2 factor	<1.5
Beam diameter at the aperture (1/e ² ,mm)	~2.0
Beam divergence, full angle (mrad)	~1.5
Polarization ratio	>50:1 (>100:1, optional) Horizontal±5 degree (Vertical Optional)
Warm-up time (minutes)	<5
Beam height from base plate (mm)	30

Operating temperature (°C)	20~30
Power supply (85-264VAC)	ST-PSU-III-FDA
Expected lifetime (hours)	10000
Warranty	1 year
Laser head dimension & weight	122.5x65x50mm / 1kg
Power supply dimension & weight	170x130x62.2mm / 1.2kg

514nm Narrow Linewidth Diode Lasers

Central wavelength (nm)	514.5±0.5
Operating mode	CW
Output power (mW)	>1, 2, 3, ...,40
Power stability (rms, over 4 hours)	<1%, <2%, <3%
Transverse mode	Near TEM00
Spectral linewidth (nm)	<0.06 (<0.03, optional)
M2 factor	<1.5
Beam diameter at the aperture (1/e ² ,mm)	~2.5
Beam divergence, full angle (mrad)	<1.5
Polarization ratio	>50:1 (>100:1, optional) Horizontal±5 degree (Vertical Optional)
Warm-up time (minutes)	<5
Beam height from base plate (mm)	30
Operating temperature (°C)	20~30
Power supply (85-264VAC)	ST-PSU-III-FDA
Expected lifetime (hours)	10000
Warranty	1 year
Laser head dimension & weight	122.5x65x50mm / 1kg
Power supply dimension & weight	170x130x62.2mm / 1.2kg

520nm Narrow Linewidth Diode Lasers

Central wavelength (nm)	520±5
Operating mode	CW
Output power (mW)	>1, 2, 3, ...,10
Power stability (rms, over 4 hours)	<1%, <3%, <5%
Transverse mode	Near TEM00
Spectral linewidth (nm)	<0.06 (<0.03, optional)
M2 factor	<1.5
Beam diameter at the aperture (1/e ² ,mm)	~3.0
Beam divergence, full angle (mrad)	<1.0
Polarization ratio	>50:1 (>100:1, optional) Horizontal±5 degree (Vertical Optional)
Warm-up time (minutes)	<5
Beam height from base plate (mm)	30
Operating temperature (°C)	20~30
Power supply (85-264VAC)	ST-PSU-III-FDA
Expected lifetime (hours)	10000
Warranty	1 year
Laser head dimension & weight	122.5x65x50mm / 1kg
Power supply dimension & weight	170x130x62.2mm / 1.2kg

633nm Narrow Linewidth Diode Lasers

Central wavelength (nm)	633±0.5
Operating mode	CW
Output power (mW)	>1, 10, 20, ...,80
Power stability (rms, over 4 hours)	<1%, <2%, <3%
Transverse mode	Near TEM00
Spectral linewidth (nm)	<0.06 (<0.03, optional)
Beam diameter at the aperture (1/e ² ,mm)	~2.0
Beam divergence, full angle (mrad)	<1.5

Polarization ratio	>50:1 (>100:1, optional) Horizontal±5 degree (Vertical Optional)
Warm-up time (minutes)	<5
Beam height from base plate (mm)	30
Operating temperature (°C)	20~30
Power supply (85-264VAC)	ST-PSU-III-FDA
Expected lifetime (hours)	10000
Warranty	1 year
Laser head dimension & weight	122.5x65x50mm / 1kg
Power supply dimension & weight	170x130x62.2mm / 1.2kg

635nm Narrow Linewidth Diode Lasers

Central wavelength (nm)	635±5
Operating mode	CW
Output power (mW)	>1, 2, 3, ...,30
Power stability (rms, over 4 hours)	<1%, <2%, <3%
Transverse mode	Near TEM00
Spectral linewidth (nm)	<0.06 (<0.03, optional)
M2 factor	<1.5
Beam diameter at the aperture (1/e ² ,mm)	~3.0
Beam divergence, full angle (mrad)	<1.0
Polarization ratio	>50:1 (>100:1, optional) Horizontal±5 degree (Vertical Optional)
Warm-up time (minutes)	<5
Beam height from base plate (mm)	30
Operating temperature (°C)	20~30
Power supply (85-264VAC)	ST-PSU-III-FDA
Expected lifetime (hours)	10000
Warranty	1 year
Laser head dimension & weight	122.5x65x50mm / 1kg
Power supply dimension & weight	170x130x62.2mm / 1.2kg

637nm Narrow Linewidth Diode Lasers

Central wavelength (nm)	637±5
Operating mode	CW
Output power (mW)	>1, 2, 3, ...,80
Power stability (rms, over 4 hours)	<1%, <2%, <3%
Transverse mode	Near TEM00
Spectral linewidth (nm)	<0.06 (<0.03, optional)
M2 factor	<1.5
Beam diameter at the aperture (1/e ² ,mm)	~3.0
Beam divergence, full angle (mrad)	<1.0
Polarization ratio	>50:1 (>100:1, optional) Horizontal±5 degree (Vertical Optional)
Warm-up time (minutes)	<5
Beam height from base plate (mm)	30
Operating temperature (°C)	20~30
Power supply (85-264VAC)	ST-PSU-III-FDA
Expected lifetime (hours)	10000
Warranty	1 year
Laser head dimension & weight	122.5x65x50mm / 1kg
Power supply dimension & weight	170x130x62.2mm / 1.2kg

640nm Narrow Linewidth Diode Lasers

Central wavelength (nm)	640±5
Operating mode	CW
Output power (mW)	>1, 2, 3, ...,30

Power stability (rms, over 4 hours)	<1%, <2%, <3%
Transverse mode	Near TEM00
Spectral linewidth (nm)	<0.06 (<0.03, optional)
M2 factor	<1.5
Beam diameter at the aperture (1/e ² ,mm)	~3.0
Beam divergence, full angle (mrad)	<1.0
Polarization ratio	>50:1 (>100:1, optional) Horizontal±5 degree (Vertical Optional)
Warm-up time (minutes)	<5
Beam height from base plate (mm)	30
Operating temperature (°C)	20~30
Power supply (85-264VAC)	ST-PSU-III-FDA
Expected lifetime (hours)	10000
Warranty	1 year
Laser head dimension & weight	122.5x65x50mm / 1kg
Power supply dimension & weight	170x130x62.2mm / 1.2kg

642nm Narrow Linewidth Diode Lasers

Central wavelength (nm)	642±5
Operating mode	CW
Output power (mW)	>1, 2, 3, ...,30
Power stability (rms, over 4 hours)	<1%, <2%, <3%
Transverse mode	Near TEM00
Spectral linewidth (nm)	<0.06 (<0.03, optional)
M2 factor	<1.5
Beam diameter at the aperture (1/e ² ,mm)	~3.0
Beam divergence, full angle (mrad)	<1.0
Polarization ratio	>50:1 (>100:1, optional) Horizontal±5 degree (Vertical Optional)
Warm-up time (minutes)	<5
Beam height from base plate (mm)	30
Operating temperature (°C)	20~30
Power supply (85-264VAC)	ST-PSU-III-FDA
Expected lifetime (hours)	10000
Warranty	1 year
Laser head dimension & weight	122.5x65x50mm / 1kg
Power supply dimension & weight	170x130x62.2mm / 1.2kg

650nm Narrow Linewidth Diode Lasers

Central wavelength (nm)	650±10
Operating mode	CW
Output power (mW)	>1, 2, 3, ...,30
Power stability (rms, over 4 hours)	<1%, <2%, <3%
Transverse mode	Near TEM00
Spectral linewidth (nm)	<0.06 (<0.03, optional)
M2 factor	<1.5
Beam diameter at the aperture (1/e ² ,mm)	~3.0
Beam divergence, full angle (mrad)	<1.0
Polarization ratio	>50:1 (>100:1, optional) Horizontal±5 degree (Vertical Optional)
Warm-up time (minutes)	<5
Beam height from base plate (mm)	30
Operating temperature (°C)	20~30
Power supply (85-264VAC)	ST-PSU-III-FDA
Expected lifetime (hours)	10000
Warranty	1 year
Laser head dimension & weight	122.5x65x50mm / 1kg
Power supply dimension & weight	170x130x62.2mm / 1.2kg

655nm Narrow Linewidth Diode Lasers

Central wavelength (nm)	655±10
Operating mode	CW
Output power (mW)	>1, 2, 3, ...,30
Power stability (rms, over 4 hours)	<1%, <2%, <3%
Transverse mode	Near TEM00
Spectral linewidth (nm)	<0.06 (<0.03, optional)
M2 factor	<1.5
Beam diameter at the aperture (1/e ² ,mm)	~3.0
Beam divergence, full angle (mrad)	<1.0
Polarization ratio	>50:1 (>100:1, optional) Horizontal±5 degree (Vertical Optional)
Warm-up time (minutes)	<5
Beam height from base plate (mm)	30
Operating temperature (°C)	20~30
Power supply (85-264VAC)	ST-PSU-III-FDA
Expected lifetime (hours)	10000
Warranty	1 year
Laser head dimension & weight	122.5x65x50mm / 1kg
Power supply dimension & weight	170x130x62.2mm / 1.2kg

660nm Narrow Linewidth Diode Lasers

Central wavelength (nm)	660±0.5
Operating mode	CW
Output power (mW)	>1, 10, 20, ...,120
Power stability (rms, over 4 hours)	<1%, <2%, <3%
Transverse mode	Near TEM00
Spectral linewidth (nm)	<0.06 (<0.03, optional)
M2 factor	<1.5
Beam diameter at the aperture (1/e ² ,mm)	~1.0
Beam divergence, full angle (mrad)	~1.0
Polarization ratio	>50:1 (>100:1, optional) Horizontal±5 degree (Vertical Optional)
Warm-up time (minutes)	<5
Beam height from base plate (mm)	30
Operating temperature (°C)	20~30
Power supply (85-264VAC)	ST-PSU-III-FDA
Expected lifetime (hours)	10000
Warranty	1 year
Laser head dimension & weight	122.5x65x50mm / 1kg
Power supply dimension & weight	170x130x62.2mm / 1.2kg

705nm Narrow Linewidth Diode Lasers

Central wavelength (nm)	705±10
Operating mode	CW
Output power (mW)	>1, 2, 3, ...,10
Power stability (rms, over 4 hours)	<1%, <2%, <3%
Transverse mode	Near TEM00
Spectral linewidth (nm)	<0.06 (<0.03, optional)
M2 factor	<1.5
Beam diameter at the aperture (1/e ² ,mm)	~3.0
Beam divergence, full angle (mrad)	<1.0
Warm-up time (minutes)	<5
Beam height from base plate (mm)	30
Operating temperature (°C)	20~30
Power supply (85-264VAC)	ST-PSU-III-FDA
Expected lifetime (hours)	10000

Warranty	1 year
Laser head dimension & weight	122.5x65x50mm / 1kg
Power supply dimension & weight	170x130x62.2mm / 1.2kg

730nm Narrow Linewidth Diode Lasers

Central wavelength (nm)	730±3
Operating mode	CW
Output power (mW)	>1, 2, 3, ...,10
Power stability (rms, over 4 hours)	<1%, <2%, <3%
Transverse mode	Near TEM00
Spectral linewidth (nm)	<0.06 (<0.03, optional)
M2 factor	<1.5
Beam diameter at the aperture (1/e ² ,mm)	~2.0
Beam divergence, full angle (mrad)	<1.5
Warm-up time (minutes)	<5
Beam height from base plate (mm)	30
Operating temperature (°C)	20~30
Power supply (85-264VAC)	ST-PSU-III-FDA
Expected lifetime (hours)	10000
Warranty	1 year
Laser head dimension & weight	122.5x65x50mm / 1kg
Power supply dimension & weight	170x130x62.2mm / 1.2kg

785nm Narrow Linewidth Diode Lasers

Central wavelength (nm)	785±0.5
Operating mode	CW
Output power (mW)	>1, 2, 3, ...,20
Power stability (rms, over 4 hours)	<1%, <2%, <3%
Transverse mode	Near TEM00
Spectral linewidth (nm)	<0.06 (<0.03, optional)
M2 factor	<1.5
Beam diameter at the aperture (1/e ² ,mm)	~2.0
Beam divergence, full angle (mrad)	<1.0
Warm-up time (minutes)	<5
Beam height from base plate (mm)	30
Operating temperature (°C)	20~30
Power supply (85-264VAC)	ST-PSU-III-FDA
Expected lifetime (hours)	10000
Warranty	1 year
Laser head dimension & weight	122.5x65x50mm / 1kg
Power supply dimension & weight	170x130x62.2mm / 1.2kg

808nm Narrow Linewidth Diode Lasers

Central wavelength (nm)	808±0.5
Operating mode	CW
Output power (mW)	>1, 2, 3, ...,20
Power stability (rms, over 4 hours)	<1%, <2%, <3%
Transverse mode	Near TEM00
Spectral linewidth (nm)	<0.06 (<0.03, optional)
M2 factor	<1.5
Beam diameter at the aperture (1/e ² ,mm)	~3.0
Beam divergence, full angle (mrad)	<1.5
Polarization ratio	>50:1 (>100:1, optional) Horizontal±5 degree (Vertical Optional)
Warm-up time (minutes)	<5
Beam height from base plate (mm)	30
Operating temperature (°C)	20~30
Power supply (85-264VAC)	ST-PSU-III-FDA

Expected lifetime (hours)	10000
Warranty	1 year
Laser head dimension & weight	122.5x65x50mm / 1kg
Power supply dimension & weight	170x130x62.2mm / 1.2kg

830nm Narrow Linewidth Diode Lasers

Central wavelength (nm)	830±0.5
Operating mode	CW
Output power (mW)	>1, 2, 3, ...,30
Power stability (rms, over 4 hours)	<1%, <2%, <3%
Transverse mode	Near TEM00
Spectral linewidth (nm)	<0.06 (<0.03, optional)
M2 factor	<1.5
Beam diameter at the aperture (1/e ² ,mm)	~3.5
Beam divergence, full angle (mrad)	<1.5
Warm-up time (minutes)	<5
Beam height from base plate (mm)	30
Operating temperature (°C)	20~30
Power supply (85-264VAC)	ST-PSU-III-FDA
Expected lifetime (hours)	10000
Warranty	1 year
Laser head dimension & weight	122.5x65x50mm / 1kg
Power supply dimension & weight	170x130x62.2mm / 1.2kg

915nm Narrow Linewidth Diode Lasers

Central wavelength (nm)	915±5
Operating mode	CW
Output power (mW)	>1, 2, 3, ...,30
Power stability (rms, over 4 hours)	<1%, <2%, <3%
Transverse mode	Near TEM00
Spectral linewidth (nm)	<0.06 (<0.03, optional)
M2 factor	<1.5
Beam diameter at the aperture (1/e ² ,mm)	~3.0
Beam divergence, full angle (mrad)	<1.0
Warm-up time (minutes)	<5
Beam height from base plate (mm)	30
Operating temperature (°C)	20~30
Power supply (85-264VAC)	ST-PSU-III-FDA
Expected lifetime (hours)	10000
Warranty	1 year
Laser head dimension & weight	122.5x65x50mm / 1kg
Power supply dimension & weight	170x130x62.2mm / 1.2kg

940nm Narrow Linewidth Diode Lasers

Central wavelength (nm)	940±5
Operating mode	CW
Output power (mW)	>1, 2, 3, ...,30
Power stability (rms, over 4 hours)	<1%, <2%, <3%
Transverse mode	Near TEM00
Spectral linewidth (nm)	<0.06 (<0.03, optional)
M2 factor	<1.5
Beam diameter at the aperture (1/e ² ,mm)	~3.5
Beam divergence, full angle (mrad)	<1.0
Warm-up time (minutes)	<5
Beam height from base plate (mm)	30
Operating temperature (°C)	20~30
Power supply (85-264VAC)	ST-PSU-III-FDA
Expected lifetime (hours)	10000

Warranty	1 year
Laser head dimension & weight	122.5x65x50mm / 1kg
Power supply dimension & weight	170x130x62.2mm / 1.2kg

975nm Narrow Linewidth Diode Lasers

Central wavelength (nm)	975±5
Operating mode	CW
Output power (mW)	>1, 2, 3, ...,30
Power stability (rms, over 4 hours)	<1%, <2%, <3%
Transverse mode	Near TEM00
Spectral linewidth (nm)	<0.06 (<0.03, optional)
M2 factor	<1.5
Beam diameter at the aperture (1/e ² ,mm)	~3.5
Beam divergence, full angle (mrad)	<1.0
Polarization ratio	>10:1 (>50:1, optional) Horizontal±5 degree (Vertical Optional)
Warm-up time (minutes)	<5
Beam height from base plate (mm)	30
Operating temperature (°C)	20~30
Power supply (85-264VAC)	ST-PSU-III-FDA
Expected lifetime (hours)	10000
Warranty	1 year
Laser head dimension & weight	122.5x65x50mm / 1kg
Power supply dimension & weight	170x130x62.2mm / 1.2kg

980nm Narrow Linewidth Diode Lasers

Central wavelength (nm)	980±0.5
Operating mode	CW
Output power (mW)	>1, 2, 3, ...,30
Power stability (rms, over 4 hours)	<1%, <2%, <3%
Transverse mode	Near TEM00
Spectral linewidth (nm)	<0.06 (<0.03, optional)
Beam diameter at the aperture (1/e ² ,mm)	~2.5
Beam divergence, full angle (mrad)	~2.5
Polarization ratio	>10:1 (>50:1, optional) Horizontal±5 degree (Vertical Optional)
Warm-up time (minutes)	<5
Beam height from base plate (mm)	30
Operating temperature (°C)	20~30
Power supply (85-264VAC)	ST-PSU-III-FDA
Expected lifetime (hours)	10000
Warranty	1 year
Laser head dimension & weight	122.5x65x50mm / 1kg
Power supply dimension & weight	170x130x62.2mm / 1.2kg

1060nm Narrow Linewidth Diode Lasers

Central wavelength (nm)	1060±10
Operating mode	CW
Output power (mW)	>1, 2, 3, ...,40
Power stability (rms, over 4 hours)	<1%, <2%, <3%
Transverse mode	Near TEM00
Spectral linewidth (nm)	<0.06 (<0.03, optional)
M2 factor	<1.5
Beam diameter at the aperture (1/e ² ,mm)	~3.5
Beam divergence, full angle (mrad)	<1.0
Warm-up time (minutes)	<5
Beam height from base plate (mm)	30
Operating temperature (°C)	20~30

Power supply (85-264VAC)	ST-PSU-III-FDA
Expected lifetime (hours)	10000
Warranty	1 year
Laser head dimension & weight	122.5x65x50mm / 1kg
Power supply dimension & weight	170x130x62.2mm / 1.2kg

STC Series Laser Diodes

We provide laser diodes with free space and fiber coupling option from 405-1550 nm wavelength range. The free space laser diode can be divided in to single mode and multimode. The fiber coupled laser diode can be divided into SM, PM, MM pigtailed and high power laser diode module. The small emitting aperture, combined with low beam divergence, make these devices the highest-brightness family of CW laser diodes available in the industry.

1. Free Space Laser Diode

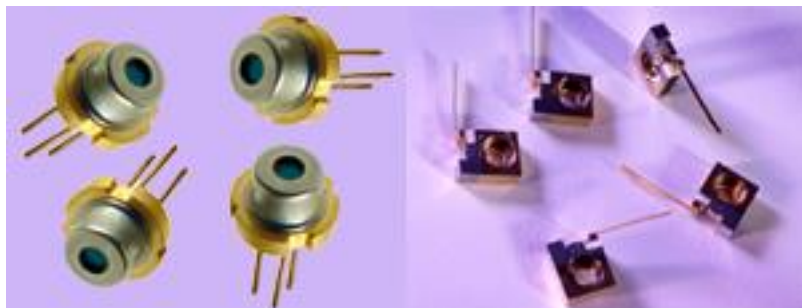

- Single Mode/ Multimode Laser Diode
- Wavelength range 405-1550 nm
- Output power range 5mW-10W
- Fabry Perot (FP) laser cavity
- Low capacitance

Wavelength (nm)	Tolerance (nm)	Power (mW)	Laser Type
405 nm	5	20	Single Mode
405 nm	5	150	Single Mode
450 nm	5	1400	Multimode
488 nm	5	60	Single Mode
637 nm	5	120-170	Single Mode
640 nm	5	150	Single Mode
658 nm	8	200	Single Mode
730 nm	10	50	Single Mode
785 nm	5	150	Single Mode
808 nm	3/5/10	200-10000	Multimode
830 nm	5	1000	Multimode
850 nm	5	50	Single Mode
940 nm	5	1500	Multimode
980 nm	5/10	50-3000	Multimode
1064 nm	5	300	Single mode
1310 nm	5	20	Single mode
1550 nm	5	20	Single mode

Detailed Specifications of Free-space Laser Diodes

Part Number	STC-SLD-405-20	STC-SLD-405-150	STC-SLD-785-150
Power (mW)	20	150	150
Package	TO-18	TO-38	TO-5
Peak Wavelength (nm)	405±5	405±5	785±5
Threshold Current (Typ.)	32mA	40mA	35mA
Operating Current (Typ.)	43mA	140mA	170mA
LD Reverse Voltage	2V	2V	2.0V
Operating Voltage	5.2V	5.2V	1.9V
Slope Efficiency	1.8W/A	1.5W/A	1.1W/A
Horizontal Beam Divergence	9deg	8.5deg	8deg
Vertical Beam Divergence	20deg	19deg	25deg
Polarization	TE	TE	TE

Operating Temperature	+10-+40°C	0-+90°C	-20-+50°C
Storage Temperature	-20-+60°C	-40-+90°C	-40-+80°C

Part Number	STC-MLD-808-200	STC-MLD-808-300	STC-MLD-808-500	STC-MLD-808-500	STC-MLD-808-1000
Power (mW)	200	300	500	500	1000
Package	TO-18	TO-18	TO-3/C-Mount	TO-5	TO-3/C-Mount
Peak Wavelength (nm)	808±3	808±3	808±5	808±3	808±5
Threshold Current (Typ.)	40mA	60mA	130mA	120mA	240mA
Operating Current (Typ.)	250mA	350mA	600mA	650mA	1240mA
LD Reverse Voltage	3.0V	3.0V	2.0V	2.0V	2.0V
Operating Voltage	2.2V	2.2V	2.0V	2.0V	2.0V
Slope Efficiency	1.2W/A	1.2W/A	1.0W/A	1.0W/A	1.0W/A
Horizontal Beam Divergence	10deg	10deg	10deg	12deg	10deg
Vertical Beam Divergence	40deg	40deg	38deg	40deg	38deg
Polarization	TE	TE	TE	TE	TE
Operating Temperature	+10-+30°C	+10-+30°C	0-+35°C	-10-+30°C	0-+35°C
Storage Temperature	-40-+80°C	-40-+80°C	-10-+60°C	-10-+85°C	-10-+60°C

Part Number	STC-MLD-808-2000	STC-MLD-808-3000	STC-MLD-808-3000	STC-MLD-808-5000	STC-MLD-808-10000
Power (mW)	2000	3000	3000	5000	10000
Package	C-Mount	C-Mount	TO-3	TO-3/C-Mount	CN-Mount
Peak Wavelength (nm)	808±3	808±3	808±10	808±3	808±3
Threshold Current (Typ.)	700mA	800mA	1000mA	1000mA	1900mA
Operating Current (Typ.)	2600mA	3500mA	3500mA	6000mA	10500mA
LD Reverse Voltage	2.0V	2.0V	2.0V	2.0V	2.0V
Operating Voltage	2.0V	2.0V	2.2V	2.0V	2.0V
Slope Efficiency	1.1W/A	1.1W/A	1.0W/A	1.05W/A	1.15W/A
Horizontal Beam Divergence	8deg	8deg	12deg	8deg	10deg
Vertical Beam Divergence	35deg	35deg	40deg	35deg	38deg
Polarization	TE	TE	TE	TE	TE
Operating Temperature	0-+55°C	0-+55°C	+10-+50°C	+15-+30°C	+15-+35°C
Storage Temperature	+15-+30°C	+15-+35°C	-40-+85°C	0-+55°C	-20-+80°C

Part Number	STC-MLD-980-50	STC-MLD-980-500	STC-MLD-980-3000
Power (mW)	50	500	3000
Package	TO-18	TO-5	C-Mount
Peak Wavelength (nm)	980±10	980±10	980±5
Threshold Current (Typ.)	25mA	150mA	700mA
Operating Current (Typ.)	120mA	850mA	3300mA
LD Reverse Voltage	2.0V	2.0V	2.0V
Operating Voltage	2.0V	2.0V	2.0V
Slope Efficiency	0.45W/A	0.9W/A	1W/A
Horizontal Beam Divergence	25deg	10deg	8deg
Vertical Beam Divergence	35deg	48deg	35deg
Polarization	TE	TE	TE
Operating Temperature	+10-+40°C	+10-+40°C	+15-+30°C
Storage Temperature	-40-+85°C	-40-+85°C	0-+55°C

2. Fiber Coupled Laser Diode Module



- Wavelength range 405-1064 nm
- High output power up to 4000W @ 915/980 nm
- Are designed for fiber laser, solid state laser pumping, direct diode material processing, surgical lasers and medical therapeutics

Part Number	Wavelength (nm)	Power (W)	Fiber Type (MM fiber)
STC-LDM-405-10	405 nm	10	800 μm
STC-LDM-405-35	405 nm	35	800 μm
STC-LDM-444-10	444 nm	10	100, 200, 400μm
STC-LDM-444-25	444 nm	25	100, 200, 400μm
STC-LDM-450-6	450 nm	6	105 μm
STC-LDM-450-9	450 nm	9	200 μm
STC-LDM-450-12	450 nm	12	200 μm
STC-LDM-450-50	450 nm	50	400 μm
STC-LDM-450-120	450 nm	120	800 μm
STC-LDM-520-30	520 nm	30	400 μm
STC-LDM-520-70	520 nm	70	800 μm
STC-LDM-638-15	638 nm	15	400 μm
STC-LDM-638-35	638 nm	35	800 μm
STC-LDM-793-8	793 nm	8	105 μm
STC-LDM-793-16	793 nm	16	105 μm
STC-LDM-793-30	793 nm	30	105 μm
STC-LDM-808-7	808 nm	7	105 μm
STC-LDM-808-15	808 nm	15	400 μm
STC-LDM-808-20	808 nm	20	400 μm
STC-LDM-808-30	808 nm	30	400 μm
STC-LDM-808-40	808 nm	40	200 μm
STC-LDM-808-50	808 nm	50	400 μm
STC-LDM-808-60	808 nm	60	200 μm
STC-LDM-808-100	808 nm	100	400 μm
STC-LDM-808-150	808 nm	150	400 μm
STC-LDM-878.6-25	878.6 nm	25	200 μm
STC-LDM-878.6-30	878.6 nm	30	400 μm
STC-LDM-878.6-60	878.6 nm	60	400 μm
STC-LDM-878.6-72	878.6 nm	72	400 μm
STC-LDM-878.6-75	878.6 nm	75	400 μm
STC-LDM-878.6-120	878.6 nm	120	400 μm
STC-LDM-915-10	915 nm	10	105 μm
STC-LDM-915-20	915 nm	20	105 μm
STC-LDM-915-30	915 nm	30	105 μm
STC-LDM-915-50	915 nm	50	200 μm
STC-LDM-915-80	915 nm	80	105 μm
STC-LDM-915-150	915 nm	150	105 μm
STC-LDM-915-260	915 nm	260	200 μm
STC-LDM-925-200	925 nm	200	135 μm
STC-LDM-976-10	976 nm	10	105 μm
STC-LDM-976-20	976 nm	20	105 μm

STC-LDM-976-27	976 nm	27	105 μm
STC-LDM-976-60	976 nm	60	105 μm
STC-LDM-976-100	976 nm	100	105 μm
STC-LDM-976-130	976 nm	130	105 μm
STC-LDM-976-140	976 nm	140	105 μm
STC-LDM-980-15	980 nm	15	200 μm
STC-LDM-980-35	980 nm	35	300 μm
STC-LDM-1064-10	1064 nm	10	200 μm
STC-LDM-1470-15	1470 nm	15	200 μm

Detailed Specifications of STC-LDM-808-150-C2

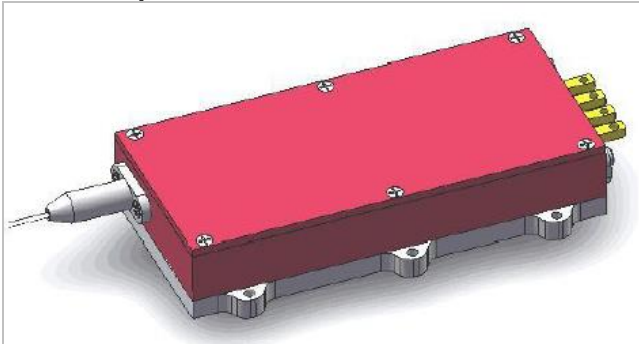

	Parameter	Symbol	Typical	Unit
Optical	CW Out Power	Pop	150	W
	Center Wavelength	λ	808±10	nm
	Spectral Width (90% of Power)	$\Delta\lambda$	<10.0	nm
	Wavelength Shift with Temperature	$\Delta\lambda/\Delta T$	0.35	nm / °C
Electrical	Threshold Current	I _{th}	1.9	A
	Operating current	I _{op}	12	A
	Operating Voltage	V _{op}	30	V
	Slope Efficiency	η	14.9	W/A
	Power Conversion Efficiency	η_{ep}	42	%
Fiber	Core Diameter	d _{core}	400	μm
	Cladding Diameter	d _{clad}	440	μm
	Buffer Diameter	d _{buffer}	700	μm
	Numerical Aperture	NA	0.22	-
	Fiber Length	L	1.0	m
	Connector	-	SMA905,FC	-
Accessories	Aiming Laser(650nm)	-	None	-
	Monitor Photodiode	-	None	-
	Dimension	-	142x72x29.5	mm

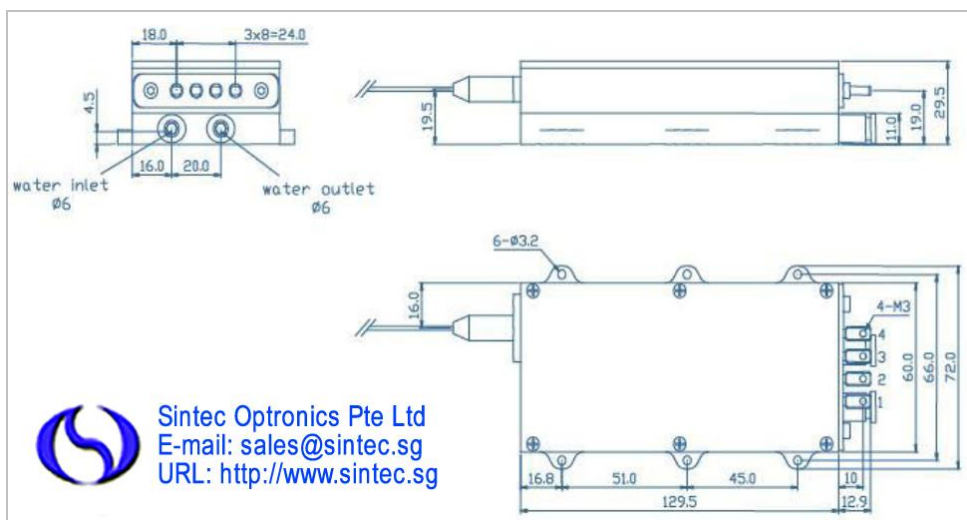

Detailed Specifications of STC-LDM-980-15

Optical	Unit	Typical Value
CW Output Power	W	15
Center Wavelength	nm	980±10
Spectral Width (90% of Power)	nm	4
Wavelength Shift with Temperature	nm / °C	0.3
Electrical		
Threshold Current	A	0.7
Operating Current	A	9.0
Operating Voltage	V	3.6
Slope Efficiency	W / A	1.8
Power Conversion Efficiency	%	46
Aiming Laser*		
CW Output Power	mW	1
Center Wavelength	nm	650±10
Operating Current	mA	<30
Operating Voltage	V	~2.2
Fiber**		
Fiber Core Diameter	□m	200
Fiber Cladding Diameter	□m	220
Fiber Buffer Diameter	□m	500
Numerical Aperture	-	0.22
Fiber Length	m	1.0
Fiber Connector	-	SMA905
Dimension	mm	52x35x17.2

*Optional built-in constant power circuit, 5V power supply needed.

Optional constant voltage green aiming beam.

**Customized fiber and connector available.

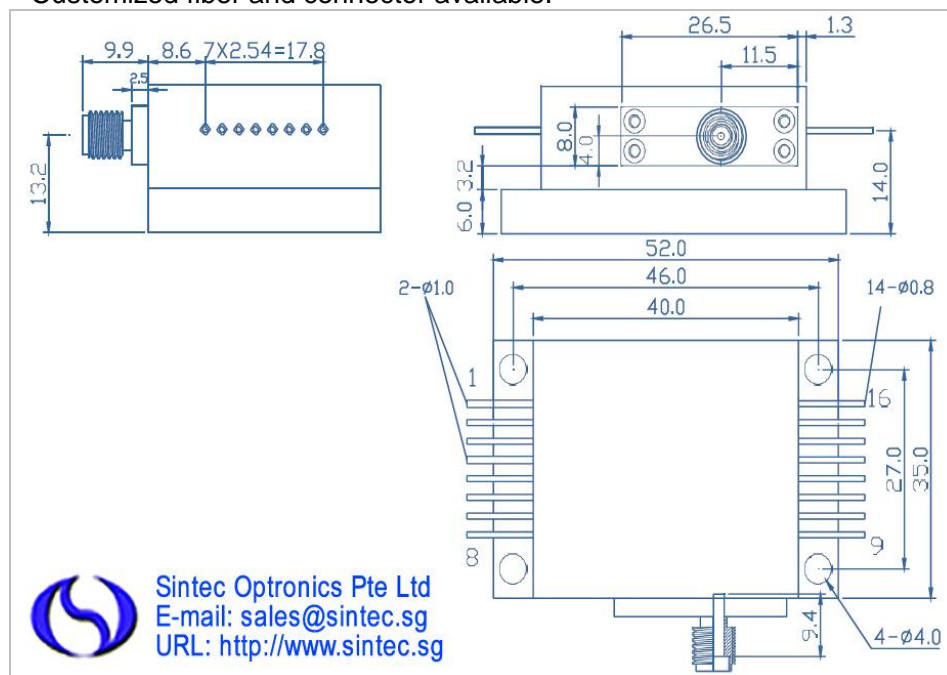

3. SM/ PM/ MM Pigtailed Laser Diodes



- Wavelength range 405-1550 nm
- Output power range 1-5000mW
- Fiber coupled Fabry Perot (FP) laser diodes
- Optional FC/PC or FC/ APC connector
- Distributed feedback (DFB)

Wavelength (nm)	Power (mW)	Laser Type	Package
405 nm	1-50	SM / PM fiber	Coaxial
405 nm	5-200	MM fiber	Coaxial
635 nm	1-100	SM / PM fiber	Coaxial
635 nm	5-350	MM fiber	Coaxial
650 nm	5-100	SM / PM fiber	Coaxial
785 nm	20-50	SM / PM fiber	Coaxial
785 nm	50-80	MM fiber	Coaxial
808 nm	30	SM / PM fiber	Coaxial
808 nm	100-150	MM fiber	Coaxial
880 nm	1-2	SM / PM fiber	Coaxial
880 nm	5	MM fiber	Coaxial
905 nm	1-30	SM / PM fiber	Coaxial
940 nm	30	SM / PM fiber	Coaxial
980 nm	5-15	SM fiber	Coaxial
980 nm	20-100	MM fiber	Coaxial
1064 nm	5-50	SM / PM fiber	Coaxial
1064 nm	20	MM fiber	Coaxial
1310 nm	2-10	SM / PM fiber	Coaxial / Pigtailed
1310 nm	10	MM fiber	Coaxial / Pigtailed
1550 nm	2-10	SM / PM fiber	Coaxial / Pigtailed
1550 nm	10	MM fiber	Coaxial / Pigtailed

Detailed Specifications of SM/ PM/ MM Pigtailed Laser Diodes

1. SM/PM Pigtailed Laser Diode at 650nm

- with SM Fiber
- with PM Fiber
- Offer Customized Products
- Offer OEM Coupling Service

Part Number	STC-SLDP-650-5-SM	STC-SLDP-650-10-SM	STC-SLDP-650-20-SM	STC-SLDP-650-20-SM-9	STC-SLDP-650-30-SM
Center Wavelength@25°C (nm)	650nm	650nm	650nm	650nm	650nm
Power (mW)	5	10	20	20	30
Package	Coaxial	Coaxial	Coaxial	Coaxial	Coaxial
Tolerance (nm)	5	5	5	5	5
Fiber Type (80cm length)	4µm SM fiber	4µm SM fiber	4µm SM fiber	9µm SM fiber	4µm SM fiber
Fiber Connector	FC/SC/SMA905	FC/SC/SMA905	FC/SC/SMA905	FC/SC/SMA905	FC/SC/SMA905
Threshold Current (Typ.)	40mA	45mA	40mA	45mA	50mA
Operating Current (Typ.)	90mA	100mA	170mA	150mA	220mA

Operating Voltage	2.7V	2.7V	2.4V	2.4V	2.5V
Reverse Voltage	2.0V	2.0V	2.0V	2.0V	2.0V
Operating Temperature	-10-+70°C	-10-+60°C	-10-+60°C	-10-+60°C	-10-+60°C
Storage Temperature	-40-+85°C	-40-+85°C	-40-+85°C	-40-+85°C	-40-+85°C
Lead Soldering Temperature	260°C	260°C	260°C	260°C	260°C

Part Number	STC-SLDP-650-50-SM	STC-SLDP-650-50-SM-9	STC-SLDP-650-50-PM	STC-SLDP-650-100-SM	STC-SLDP-650-100-SM-9	STC-SLDP-650-100-PM
Center Wavelength@25°C (nm)	650nm	650nm	650nm	650nm	650nm	650nm
Power (mW)	50	50	50	100	100	100
Package	Coaxial	Coaxial	Coaxial	Coaxial	Coaxial	Coaxial
Tolerance (nm)	5	5	5	5	5	5
Fiber Type (80cm length)	4µm SM fiber	9µm SM fiber	PM UV fiber	4µm SM fiber	9µm SM fiber	PM UV fiber
Fiber Connector	FC/SC/SMA905	FC/SC/SMA905	FC/SC/SMA905	FC/SC/SMA905	FC/SC/SMA905	FC/SC/SMA905
Threshold Current (Typ.)	50mA	50mA	55mA	55mA	55mA	55mA
Operating Current (Typ.)	220mA	200mA	200mA	260mA	260mA	260mA
Operating Voltage	2.6V	2.5V	2.5V	2.7V	2.7V	2.7V
Reverse Voltage	2.0V	2.0V	2.0V	2.0V	2.0V	2.0V
Operating Temperature	-10-+50°C	-10-+60°C	-10-+50°C	-10-+50°C	-10-+50°C	-10-+50°C
Storage Temperature	-40-+85°C	-40-+85°C	-40-+85°C	-40-+85°C	-40-+85°C	-40-+85°C
Lead Soldering Temperature	260°C	260°C	260°C	260°C	260°C	260°C









2. MM Pigtailed Laser Diode at 980nm

980nm Coaxial Package Diode Laser

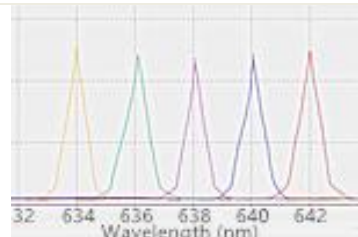
- with MM Fiber
- Offer Customized Products
- Offer OEM Coupling Service

Part Number	STC-MLDP-980-20-MM	STC-MLDP-980-100-MM
Center Wavelength@25°C (nm)	980nm	980nm
Spectral Width (FWHM)	2.0nm	2.0nm
Power (mW)	20	100
Package	Coaxial	Coaxial
Tolerance (nm)	10	10
Fiber Type (80cm length)	MM fiber	MM fiber
Fiber Connector	FC/SC/SMA905	FC/SC/SMA905
Threshold Current (Typ.)	10mA	55mA
Operating Current (Typ.)	75mA	350mA
Operating Voltage	1.5V	1.6V
Reverse Voltage	2.0V	2.0V
Operating Temperature	-10-+40°C	-10-+40°C
Storage Temperature	-15-+85°C	-15-+85°C
Lead Soldering Temperature	260°C(10 sec.)	260°C(10 sec.)

Diode Laser Modules

 High Stability Laser Good beam quality, ultra compact, Long-term stability <1%	 TEM₀₀ Mode Diode Laser Perfect beam with TEM ₀₀ mode	 Wavelength Tunable Laser Multi-wavelength bands optional Min. linewidth <0.06nm
 Narrow Linewidth Laser Linewidth <0.06 nm (<0.03 nm optional)	 Ultra Narrow Linewidth Laser Ultra narrow linewidth 8×10^{-8} nm	 Long Coherence Length Laser Coherence length >1 m 400nm-642nm wavelength available
 Nanosecond Pulsed Laser Tunable pulse width 5 - 150 ns 405 - 1550 nm available	 Picosecond Pulsed Laser Rep. rate 0.1 ~ 80 MHz Pulse width 100 - 1000 ps	 DFB/ DBR/ VCSEL Laser Narrow linewidth up to 2 MHz

1. TEM₀₀ Mode Diode Laser

We offer TEM₀₀ mode diode laser, which is made features of TEM₀₀ mode, high performance, ultra compact, long lifetime, low cost and easy operating. It is widely used in measurement, communication, scientific experiment, spectrum analysis, optical instrument and so on, are the perfect choice for design in and integration into OEM instrumentation and systems and also for end user applications in research and development.



Model	Operating mode	Output power (mW)	M ² factor
STC-TEM-F-405	CW	1~30	<1.1
STC-TEM-F-450	CW	1~20	<1.1
STC-TEM-F-488	CW	1~15	<1.1
STC-TEM-F-520	CW	1~20	<1.1
STC-TEM-F-635	CW	1~80	<1.1
STC-TEM-F-640	CW	1~40	<1.1
STC-TEM-F-660	CW	1~50	<1.1
STC-TEM-F-685	CW	1~20	<1.1
STC-TEM-F-785	CW	1~40	<1.1
STC-TEM-F-808	CW	1~20	<1.1
STC-TEM-F-830SLD	CW	1~20	<1.1

STC-TEM-F-830	CW	1~60	<1.1
STC-TEM-F-1310	CW	1~5	<1.1
STC-TEM-F-1053SLD	CW	1~8	<1.1
STC-TEM-F-1550	CW	1~5	<1.1

2. Long Coherence Length STC-MDL-C Series Diode Lasers

STC-MDL-C series lasers, with the characteristic of long coherence length >1m, are ideal for application in holography, photoetching interference, DNA sequencing, flow cytometry, digital imaging, analytical chemistry, particle measurement, confocal microscopy, Raman spectroscopy and many other fields. Housed in ultra compact package, these lasers are the perfect choice for OEM instrumentation, systems design and integration, and also for end user applications in research and development.



Model	Wavelength (nm)	Output power (mW)	Coherent length (m)
STC-MDL-C-400	400	1~50	>1
STC-MDL-C-405	405	1~50	>1
STC-MDL-C-410	410	1~50	>1
STC-MDL-C-415	415	1~50	>1
STC-MDL-C-442	442	1~30	>1
STC-MDL-C-445	445	1~30	>1
STC-MDL-C-447	447	1~30	>1
STC-MDL-C-450	450	1~30	>1
STC-MDL-C-457	457	1~30	>1
STC-MDL-C-488	488	1~70	>1
STC-MDL-C-514.5	514.5	1~40	>1
STC-MDL-C-520	520	1~10	>1
STC-MDL-C-635	635	1~30	>1
STC-MDL-C-637	637	1~80	>1
STC-MDL-C-640	640	1~30	>1
STC-MDL-C-642	642	1~30	>1

3. Nanosecond Pulsed Diode Laser

We offer nanosecond pulsed diode laser, with tunable pulse width 10ns-10ms (external trigger), good beam profile and high power stability. It has ultra compact design that can be easily integrated into customers instrument. This series laser can be widely used in microelectronics, solar energy, material processing, equipment integration, etc..nm,



Features:

High frequency modulation; Good beam profile; Integrated electronics; Compact size

Applications:

Microelectronics; Material processing; Solar energy; Equipment integration

STC-MDL-NS Series

Model	Wavelength	Output Power @3.3VDC (CW)	User Trigger Frequency (MHz)	Pulse Width (tunable, external trigger mode)
STC-MDL-NS-405	405 nm	1-500 mW	Up to 80	10ns -10 ms
STC-MDL-NS-450	450 nm	1-80 mW	Up to 50	10ns -10 ms
STC-MDL-NS-520	520 nm	1-100 mW	Up to 50	10ns -10 ms
STC-MDL-NS-635	635 nm	1-200mW	Up to 40	10ns -10 ms
STC-MDL-NS-642	642 nm	1-80 mW	Up to 30	10ns -10 ms
STC-MDL-NS-655	655 nm	1~180 mW	Up to 30	10ns -10 ms
STC-MDL-NS-785	785 nm	1-100 mW	Up to 30	10ns -10 ms
STC-MDL-NS-808	808 nm	1-100 mW	Up to 40	10ns -10 ms

STC-MDL-NS-830	830 nm	1-120 mW	Up to 20	10ns -10 ms
STC-MDL-NS-852	852 nm	1-150 mW	Up to 30	10ns -10 ms
STC-MDL-NS-915	915 nm	1-200 mW	Up to 30	10ns -10 ms
STC-MDL-NS-980	980 nm	1-200 mW	Up to 40	10ns -10 ms
STC-MDL-NS-1060	1060 nm	1-200 mW	Up to 40	10ns -10 ms

STC-MDL-III-P Series

Model	Wavelength	Peak Power	Repetition Rate	Pulse Width
STC-MDL-III-P-905	905 nm	~135W (@10kHz)	1~10kHz	~20ns (@10kHz)
STC-MDL-III-P-1550	1550 nm	~15.3W (@6kHz)	1~6kHz	~150ns (@6kHz)

4. DFB/ DBR/ VCSEL Laser

We offer DFB/ DBR/ VCSEL laser, which is special designed for gas detection such as CH₄, H₂S, NH₃, H₂O, CO, CO₂, C₂H₄, HF, C₂H₂, etc. Features with narrow linewidth up to 2MHz, ultra compact dimension, high power and wavelength stability, they are widely used in fiber gas detection, seed light source, fiber optical sensing field, etc.nm,

Features:

Stable wavelength and output power; Narrow linewidth; No jump mode output in operating current range

Applications:

Optical fiber gas detection system; Optical sensing; Fiber communications



Laser Wavelength for Gas Detection

as Composition	Chemical Formula	Absorption Spectrum
Methane	CH ₄	1650.9 nm, 1653.7 nm
Hydrogen sulfide	H ₂ S	1578 nm, 1590 nm
Ammonia	NH ₃	1512 nm
Carbon monoxide	CO	1567 nm
Carbon dioxide	CO ₂	1580 nm
Acetylene	C ₂ H ₂	1532.68 nm
Ethylene	C ₂ H ₄	1620 nm, 1625 nm, 1627 nm
Hydrogen fluoride	HF	1268.7 nm, 1273 nm, 1305 nm, 1312 nm
Water	H ₂ O	1368 nm, 1392 nm

Lasers for Fiber Communication:

Model	Wavelength	Output Power
STC-TEM-F-1268DFB	1268 nm	1-10 mW
STC-TEM-F-1273DFB	1273 nm	1-10 mW
STC-TEM-F-1305DFB	1305 nm	1-10 mW
STC-TEM-F-1310DFB	1310 nm	1-10 mW
STC-TEM-F-1312DFB	1312 nm	1-10 mW
STC-TEM-F-1368DFB	1368 nm	1-10 mW
STC-TEM-F-1392DFB	1392 nm	1-10 mW
STC-TEM-F-1450DFB	1450 nm	1-20 mW
STC-TEM-F-1470DFB	1470 nm	1-20 mW
STC-TEM-F-1490DFB	1490 nm	1-20 mW
STC-TEM-F-1512DFB	1512 nm	1-10 mW
STC-TEM-F-1532DFB	1532 nm	1-20 mW
STC-TEM-F-1540DFB	1540 nm	1-20 mW
STC-TEM-F-1550DFB	1550 nm	1-30 mW
STC-TEM-F-1560DFB	1560 nm	1-20 mW
STC-TEM-F-1567DFB	1567 nm	1-10 mW
STC-TEM-F-1573DFB	1573 nm	1-20 mW
STC-TEM-F-1578DFB	1578 nm	1~10 mW
STC-TEM-F-1580DFB	1580 nm	1~10 mW
STC-TEM-F-1590DFB	1590 nm	1-20 mW

STC-TEM-F-1610DFB	1610 nm	1-20 mW
STC-TEM-F-1620DFB	1620 nm	1~10 mW
STC-TEM-F-1625DFB	1625 nm	1~10 mW
STC-TEM-F-1627DFB	1627 nm	1~10 mW
STC-TEM-F-1651DFB	1651 nm	1~10 mW
STC-TEM-F-1653DFB	1653 nm	1~10 mW

Fiber Lasers

We offer fiber lasers with compact OEM modular design which is ideal for systems integration. They are widely used in communication, lidar, medical cosmetology, optical instrument, interference, holography, spectrum analysis, pump source, measurement, physics experiment, etc. The 1550 nm and 1064nm fiber laser are in single longitudinal and polarized mode. The pulsed mode up to 1MHz modulation and pulse duration variation are also available.

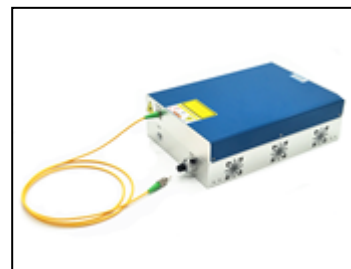

Model	Wavelength (nm)	Output power (mW)	Pulse width	Modulation rate	Longitudinal mode	Polarization
STC-FL-266-PS	266	1-10	<10 ps	20-60 MHz	Multi-	>15dB
STC-FL-343-PS	343	1-50	<10 ps	20-50 MHz	Multi-	>15dB
STC-FL-355-PS	355	1-50	<10 ps	20-60 MHz	Multi-	>15dB
STC-FL-515-PS	515	1-200	<10 ps	20-50 MHz	Multi-	>15dB
STC-FL-532-PS	532	1-150	<10 ps	20-60 MHz	Multi-	>15dB
STC-FL-1030-PS	1030	1-2000	<10 ps	20-50 MHz	Multi-	Random/ >15dB
STC-FL-1030-PS-Seed	1030	0.5-1	<10 ps	20-50 MHz	Multi-	Random/ >15dB
STC-FL-1064-PS	1064	1-2000	<10 ps	20-60 MHz	Multi-	Random/ >15dB
STC-FL-1064-PS-Seed	1064	0.5-1	<10 ps	20-60 MHz	Multi-	Random/ >15dB
STC-FL-266-Pico	266	1-50	100-900 ps	0.1-20 MHz	Multi-	>15dB
STC-FL-343-Pico	343	1-50	100-900 ps	0.1-20 MHz	Multi-	>15dB
STC-FL-355-Pico	355	1-50	100-900 ps	0.1-20 MHz	Multi-	>15dB
STC-FL-515-Pico	515	1-1000	100-900 ps	0.1-20 MHz	Multi-	>15dB
STC-FL-532-Pico	532	1-1000	100-900 ps	0.1-20 MHz	Multi-	>15dB
STC-FL-535-Pico	535	1-1000	100-900 ps	0.1-20 MHz	Multi-	>15dB
STC-FL-1030-Pico	1030	10-5000	100-900 ps	0.1-20 MHz	Multi-	Random/ >15dB
STC-FL-1064-Pico	1064	10-5000	100-900 ps	0.1-20 MHz	Multi-	Random/ >15dB
STC-FL-1070-Pico	1070	10-5000	100-900 ps	0.1-20 MHz	Multi-	Random/ >15dB
STC-FL-1030-S	1030	1 uW-200 mW Peak power	5-100 ns (Adjustable)	1 Hz-10 MHz	Multi-	Random/ >15dB
STC-FL-1064-S	1064	1 uW-500 mW Peak power	5-100 ns (Adjustable)	1 Hz-10 MHz	Multi-	Random/ >15dB
STC-FL-1550-S	1550	1uW-10 mW Peak power	5-100 ns (Adjustable)	1 Hz-10 MHz	Multi-	Random/ >15dB
STC-FL-266-Nano	266	1-50	0.5-50 ns	0.1-1 MHz	Multi-	>15dB
STC-FL-343-Nano	343	10-300	0.5-50 ns	0.1-1 MHz	Multi-	>15dB
STC-FL-355-Nano	355	1-300	0.5-50 ns	0.1-1 MHz	Multi-	>15dB
STC-FL-515-Nano	515	1-1000	0.5-50 ns	0.1-1 MHz	Multi-	>15dB
STC-FL-532-Nano	532	1-1000	0.5-50 ns	0.1-1 MHz	Multi-	>15dB
STC-FL-535-Nano	535	1-1000	0.5-50 ns	0.1-1 MHz	Multi-	>15dB
STC-FL-1030-Nano	1030	0.5-10 W	0.5-250 ns (Variable)	0.1-1 MHz	Multi-	Random/ >15dB
STC-FL-1064-Nano	1064	1000-5000	0.5-250 ns (Variable)	0.1-1 MHz	Multi-	Random/ >15dB
STC-FL-1070-Nano	1070	0.5-10 W	0.5-250 ns (Variable)	0.1-1 MHz	Multi-	Random/ >15dB
STC-FL-1550-Nano	1550	50-1000	0.5-50 ns (Variable)	50-1000 kHz	Multi-	Random/ >15dB
STC-FL-532-AO	532	10-100 nJ	0.5-50 ns	1-1000 Hz	Multi-	Random/ >15dB
STC-FL-1064-AO	1064	1-20 uJ	0.5-50 ns	1-1000 Hz	Multi-	Random/ >15dB
STC-FL-1550-AO	1550	1-20 uJ	0.5-50 ns	1-200 Hz	Multi-	Random/ >15dB
STC-FL-1064-CW	1064	1-20 W	N/A	CW/ modulated	Multi-	Random/ >15dB
STC-FL-1080-CW	1080	1-20 W	N/A	CW/ modulated	Multi-	Random/ >15dB
STC-FL-1550-CW	1550	1-20 W	N/A	CW/ modulated	Multi-	Random/ >15dB
STC-FL-1064-SF	1064	1-500	N/A	CW	Single	>15dB
STC-FL-1550-SF	1550	1-1000	N/A	CW	Single	>15dB

Multi-line Laser/ Multi-wavelength Laser

We offer multi-line laser/ multi-wavelength laser combiner systems in free space and fiber output, it can combine multiple wavelengths into one box, with optional USB or RS232 control. The wavelengths are available for UV-Visible-IR range. This multi-line lasers can be widely used for medical, biomedical, and industrial application, etc.

1. Free Space Output

- Separate laser head and driver for easy integration
- 320-1064nm wide range of wavelengths available
- 2-4 wavelengths can be combined into one system (more wavelengths on request)
- Customized wavelength and output power combinations
- Free space or MM fiber output optional

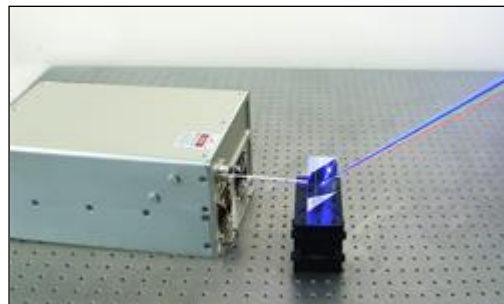

Specifications: (X stands for the number of wavelength, X= II, III, IV)

Model	STC-MSII-M STC-MSIII-M STC-MSIV-M	STC-MSII-S STC-MSIII-S STC-MSIV-S	STC-MSII-N STC-MSIII-N STC-MSIV-N	STC-MSII-W STC-MSIII-W STC-MSIV-W	STC-MSII-Z STC-MSIII-Z STC-MSIV-Z
Power supply	STC-PSU-M-LED		STC-RGB-31 / STC-RGB-41		
Number of combined wavelengths	2~4 (Or more on request)				
Output mode	Free coaxially output (fiber output optional)				
Available Wavelength (nm)	320~1064				
Output power (mW)	Available for customized on request				
Power stability (rms, over 4 hours)	<1%, <2%, <3%, <5%				
Operating mode	CW, TTL or analog on request				
Operating temperature (°C)	10~35°C				
Power input	100~240VAC				
Cooling method	Air cooled				
Expected lifetime (hours)	10000				
Options:	<ul style="list-style-type: none"> ● TTL or analog modulation up to 30kHz ● AOM (modulation up to 1MHz) ● MM fiber coupling (100um, ..., 600um), SMA905/ FC connector optional ● USB or RS232 control 				

Standard model:

- ◆ 405nm/ 561nmnm, ◆ 473nm/ 593.5nmnm, ◆ 405nm/ 473nm/ 532nmnm, ◆ 640nm/ 532nm/ 405nm
- ◆ 405nm/ 589nmnm, ◆ 635nm/ 532nmnm, ◆ 635nm/ 532nm/ 473nmnm, ◆ 655nm/ 532nm/ 473nm
- ◆ 405nm/ 593.5nmnm, ◆ 655nm/ 532nmnm, ◆ 637nm/ 532nm/ 447nmnm, ◆ 671nm/ 532nm/ 473nm
- ◆ 473nm/ 589nm

1.1 Dual-wavelength Laser Systems

It can emit up to two wavelengths from one aperture and with separate power monitors for each wavelength. They are widely used for life sciences, fluorescence, spectral analysis, optogenetics.

Model	STC-MSII-W-405/561	STC-MSII-W-405/589	STC-MSII-W-405/593.5
Wavelength (nm)	405/561	405/589	405/593.5
Operating mode	CW	CW	CW
Total output power (mW)	>1, 10,20, ..., 200	>1, 10,20, ..., 100	>1, 10,20, ..., 100
Power stability (rms, over 4 hours)	<2%, <3%, <5%	<2%, <3%, <5%	<2%, <3%, <5%

Transverse mode	near TEM ₀₀ /TEM ₀₀	near TEM ₀₀ /TEM ₀₀	near TEM ₀₀ /TEM ₀₀
Beam diameter at aperture (mm)	~2.5	~2.5	~2.5
Beam divergence, full angle (mrad)	<1.5	<1.5	<1.5
Warm-up time (minutes)	<10	<10	<10
Operating temperature (°C)	10~35	10~35	10~35
Power supply (100-240VAC)	STC-RGB-31	STC-RGB-31	STC-RGB-31
TTL/analog modulation	TTL or analog with 1Hz-1kHz, 1-10kHz or 10-30kHz	TTL or analog with 1Hz-1kHz, 1-10kHz or 10-30kHz	TTL or analog with 1Hz-1kHz, 1-10kHz or 10-30kHz
Expected lifetime (hours)	10000	10000	10000
Warranty	1 year	1 year	1 year
Dimension (laser head, mm)	353×211×136	353×211×136	353×211×136
Weight (laser head, kg)	13.0	13.0	13.0
Dimension (power supply, mm)	305.5×215×120	305.5×215×120	305.5×215×120
Weight (power supply, kg)	5	5	5

nm,

Model	STC-MSII-W-473/589	STC-MSII-W-473/593.5
Wavelength (nm)	473/589	473/593.5
Operating mode	CW	CW
Total output power (mW)	>1, 10,20, ..., 200	>1, 10,20, ..., 100
Power stability (rms, over 4 hours)	<2%, <3%, <5%	<2%, <3%, <5%
Transverse mode	near TEM ₀₀ /TEM ₀₀	near TEM ₀₀ /TEM ₀₀
Beam diameter at aperture (mm)	~3	~2.0
Beam divergence, full angle (mrad)	<1.5	<1.5
Warm-up time (minutes)	<10	<10
Operating temperature (°C)	10~35	10~35
Power supply (100-240VAC)	STC-RGB-31	STC-RGB-31
TTL/analog modulation	TTL or analog with 1Hz-1kHz, 1-10kHz or 10-30kHz	TTL or analog with 1Hz-1kHz, 1-10kHz or 10-30kHz
Expected lifetime (hours)	10000	10000
Warranty	1 year	1 year
Dimension (laser head, mm)	353×211×136	353×211×136
Weight (laser head, kg)	13.0	13.0
Dimension (power supply, mm)	305.5×215×120	305.5×215×120
Weight (power supply, kg)	5	5

Model	STC-MSII-N-635/532	STC-MSII-N-655/532
Wavelength (nm)	635/532	655/532
Operating mode	CW	CW
Total output power (mW)	>1, 10,20, ..., 200	>1, 10,20, ..., 500
Power stability (rms, over 4 hours)	<2%, <3%, <5%	<2%, <3%, <5%
Transverse mode	near TEM ₀₀ /TEM ₀₀	Multimode /TEM ₀₀
Beam diameter at aperture (mm)	~3	~5x8
Beam divergence, full angle (mrad)	<1.5	<3
Warm-up time (minutes)	<10	<10
Operating temperature (°C)	10~35	10~35
Power supply (100-240VAC)	STC-RGB-31	STC-RGB-31
TTL/analog modulation	TTL or analog with 1Hz-1kHz, 1-10kHz or 10-30kHz	TTL or analog with 1Hz-1kHz, 1-10kHz or 10-30kHz
Expected lifetime (hours)	10000	10000
Warranty	1 year	1 year
Dimension (laser head, mm)	296×170×73	296×170×73
Weight (laser head, kg)	4.2	4.2
Dimension (power supply, mm)	305.5×215×120	305.5×215×120
Weight (power supply, kg)	5	5

1.2 Triple-wavelength Laser Systems

It can provide various kinds of colors, such as red, orange, yellow, green, indigo, blue, purple. It is widely used for laser scientific research, medical treatment, OEM field and multimedia entertainment.

Model	STC-MSIII-W-405/473/532	STC-W-635/532/473*	STC-MSIII-M-637/532/447*
Wavelength (nm)	405/473/532	635/532/473	637/532/447
Operating mode	CW	CW	CW
Total output power (mW)	>1, 50, 100, ..., 300	>1, 100, 200, ..., 500	>1, 10, 20, ..., 300
Power stability (rms, over 4 hours)	<2%, <3%, <5%	<2%, <3%, <5%	<2%, <3%, <5%
Transverse mode	near TEM ₀₀ /TEM ₀₀ /TEM ₀₀	near TEM ₀₀ /TEM ₀₀ /TEM ₀₀	Near TEM ₀₀ /TEM ₀₀ /Near TEM ₀₀
Beam diameter at aperture (mm)	~2.5	~3.0	~3.0
Beam divergence, full angle (mrad)	<1.5	<1.5	<1.5
Warm-up time (minutes)	<10	<10	<10
Operating temperature (°C)	10~35	10~35	10~35
Power supply (100-240VAC)	STC-RGB-31	STC-RGB-31	STC-PSU-M-LED
TTL/analog modulation	TTL or analog with 1Hz-1kHz, 1-10kHz or 10-30kHz	TTL or analog with 1Hz-1kHz, 1-10kHz or 10-30kHz	TTL or analog with 1Hz-1kHz, 1-10kHz or 10-30kHz
Expected lifetime (hours)	10000	10000	10000
Warranty	1 year	1 year	1 year
Dimension (laser head, mm)	353×211×136	353×211×136	115×75×45
Weight (laser head, kg)	13.0	13.0	1.2
Dimension (power supply, mm)	305.5×215×120	305.5×215×120	201.5×134×102
Weight (power supply, kg)	5	5	1.2

* The combination of red, green & blue laser can generate multi-colors, such as red, orange, yellow, green, indigo, blue, purple and so much. The higher power red, green and blue laser modules are available upon request.

Model	STC-MSIII-S-640/532/405	STC-MSIII-W-655/532/473*	STC-MSIII-W-671/532/473*
Wavelength (nm)	640/532/405	655/532/473	671/532/473
Operating mode	CW	CW	CW
Total output power (mW)	>1, 50, 100, ..., 300	>1, 100, 200, ..., 1000	>1, 50, 100, ..., 300
Power stability (rms, over 4 hours)	<2%, <3%, <5%	<2%, <3%, <5%	<2%, <3%, <5%
Transverse mode	near TEM ₀₀ /TEM ₀₀ /near TEM ₀₀	Multimode/TEM ₀₀ /TEM ₀₀	TEM ₀₀ /TEM ₀₀ /TEM ₀₀
Beam diameter at aperture (mm)	~3.0	~5x8	~3.0
Beam divergence, full angle (mrad)	<1.5	<3.0	<1.5
Warm-up time (minutes)	<10	<10	<10
Operating temperature (°C)	10~35	10~35	10~35
Power supply (100-240VAC)	STC-PSU-M-LED	STC-RGB-31	STC-RGB-31
TTL/analog modulation	TTL or analog with 1Hz-1kHz, 1-10kHz or 10-30kHz	TTL or analog with 1Hz-1kHz, 1-10kHz or 10-30kHz	TTL or analog with 1Hz-1kHz, 1-10kHz or 10-30kHz
Expected lifetime (hours)	10000	10000	10000
Warranty	1 year	1 year	1 year
Dimension (laser head, mm)	185×85×56	353×211×136	353×211×136
Weight (laser head, kg)	1.5	13.0	13.0
Dimension (power supply, mm)	201.5×134×102	305.5×215×120	305.5×215×120
Weight (power supply, kg)	1.2	5	5

* The combination of red, green & blue laser can generate multi-colors, such as red, orange, yellow, green, indigo, blue, purple and so much. The higher power red, green and blue laser modules are available upon request.

2. Fiber Coupling Version

- Single mode fiber coupling with stable output
- Separate laser head and driver for easy integration
- 320-1064nm wide range of wavelengths available
- 2-4 wavelengths can be combined into one system (more wavelengths on request)
- Customized wavelength and output power combinations
- Customized size available



Standard model:

- ◆637nm/ 532nm, nm, ◆637nm/ 532nm/ 473nm, nm, ◆640nm/ 561nm/ 488nm/ 405nm
- ◆671nm/ 532nm/ 457nm, nm, ◆640nm/ 593.5nm/ 532nm/ 488nm, nm, ◆642nm/589nm/532nm/473nm

These multi-wavelength lasers can provide various kinds of colors, such as red, orange, green, etc. They are widely used for fluorescence microscopy, flow cytometry, confocal microscopy and optogenetics.

Model	STC-MSII-F-637/532	STC-MSIII-F-637/532/473	STC-MSIII-F-671/532/457
Wavelength (nm)	637/532	637/532/473	671/532/457
Operating mode	CW	CW	CW
Total output power (mW)	>1, 10, 20, ..., 100	>1, 10, 20, ..., 225	>1, 10, 20, ..., 75
Power stability (rms, over 4 hours)	<2%, <3%, <5%	<2%, <3%, <5%	<2%, <3%, <5%
Fiber core diameter (um)	Single mode	Single mode	Single mode
Fiber connector	FC	FC	FC
Fiber length (m)*	1	1	1
Warm-up time (min)	<10	<10	<10
Operating temperature (°C)	10~35	10~35	10~35
Power supply (100-240VAC)	STC-RGB-31	STC-RGB-31	STC-RGB-31
TTL/analog modulation	TTL or analog with 1Hz-1kHz, 1-10kHz or 10-30kHz	TTL or analog with 1Hz-1kHz, 1-10kHz or 10-30kHz	TTL or analog with 1Hz-1kHz, 1-10kHz or 10-30kHz
Expected lifetime (hours)	10000	10000	10000
Warranty	1 year	1 year	1 year
Dimension (laser head, mm)	329.5×258×88	308.7×288×88	373.7×288×88
Weight (laser head, kg)	10.0	12.0	12.0
Dimension (power supply, mm)	305.5×215×120	305.5×215×120	305.5×215×120
Weight (power supply, kg)	5	5	5

Model	STC-MSIV-F-640/561/488/405	STC-MSIV-F-640/593.5/532/488	STC-MSIV-F-642/589/532/473
Wavelength (nm)	640/561/488/405	640/593.5/532/488	642/589/532/473
Operating mode	CW	CW	CW
Total output power (mW)	>1, 10, 20, ..., 160	>1, 10, 20, ..., 80	>1, 10, 20, ..., 60
Power stability (rms, over 4 hours)	<2%, <3%, <5%	<2%, <3%, <5%	<2%, <3%, <5%
Fiber core diameter (um)	Single mode	Single mode	Single mode
Fiber connector	FC	FC	FC
Fiber length (m)*	1	1	1
Warm-up time (min)	<10	<10	<10
Operating temperature (°C)	10~35	10~35	10~35
Power supply (100-240VAC)	STC-RGB-41	STC-RGB-41	STC-RGB-41
TTL/analog modulation	TTL or analog with 1Hz-1kHz, 1-10kHz or 10-30kHz	TTL or analog with 1Hz-1kHz, 1-10kHz or 10-30kHz	TTL or analog with 1Hz-1kHz, 1-10kHz or 10-30kHz
Expected lifetime (hours)	10000	10000	10000
Warranty	1 year	1 year	1 year
Dimension (laser head, mm)	373.7×288×88	373.7×288×88	373.7×288×88
Weight (laser head, kg)	14.0	14.0	14.0
Dimension (power supply, mm)	305.5×215×120	305.5×215×120	305.5×215×120
Weight (power supply, kg)	5	5	5

* Other fiber lengths available upon request.

3. Integrated Electronics:

It has integrated laser diode, laser cavity, fiber coupling optics, laser power supply and LD current in ONE box. They are widely used for medical, biomedical and industrial.

- Built-in driver for easy operation
- 375-1550nm wide range of wavelengths available
- 2-20 wavelengths can be combined into one system



- Customized wavelength and output power combinations
- Customized size available

Channel type Model	Single Channel			Multi-Channel
	STC-FC-MS	STC-FC-ML	Customized model	STC-FC-MS-CH
Available wavelength (nm)	375~1064			375~1550
Number of combined wavelengths	2~3	4~6	7~20	2~4
Fiber type	SM, MM			SM
Fiber core diameter (μm)	Customized on request			4~9
Fiber connector	SMA905/ FC			FC/PC
Output power	Customized on request			
Power stability (rms, over 4 hours)	<3%, <5%			
Operating mode	CW, TTL or analog on request			
Operating temperature(°C)	10~35			
Power input	100~240VAC			
Cooling method	Air cooled			
Expected lifetime (hours)	10000			
Warranty	1 year			

Standard model:

◆405nm/ 447nm/ 532nm/ 637nm nm, ◆405nm/ 488nm/ 532nm/ 637nm

Model	STC-FC-ML-405/447/532/637	STC-FC-ML-405/488/532/637
Wavelength (nm)	405/447/532/637	405/488/532/637
Operating mode	CW	CW
Fiber core diameter (um)	400	400
Fiber connector	SMA905	SMA905
Total output power (mW)	>1, 10, 20, ..., 160	>1, 10, 20, ..., 160
Power stability (rms, over 4 hours)	<2%, <3%, <5%	<2%, <3%, <5%
Input power	100-240VAC, 50 to 60 Hz	100-240VAC, 50 to 60 Hz
Warm-up time (min)	<10	<10
Operating temperature (°C)	10~35	10~35
TTL/analog modulation	TTL or analog with 1Hz-1kHz, 1-10kHz or 10-30kHz	TTL or analog with 1Hz-1kHz, 1-10kHz or 10-30kHz
Cooling	Air	Air
Warranty	1 year	1 year
Dimension (mm)	366×341×161	366×341×161
Weight (kg)	3.0	3.0

Wavelength Tunable Lasers

We offer wavelength tunable laser, the output wavelengths can be changed continuously within a certain range. Tunable lasers come with good beam quality, high stability and long life time, they are widely used in spectroscopy, photochemistry, medicine, biology, integrated optics, laser processing, etc.

Features:

Good beam quality; Compact design; High stability; Long life time; Easy operation

Applications:

Spectroscopy;nm, Medicine; Photochemistry; Biology; Integrated optics



◆Tunable Diode Laser

Tunable Wavelength Band	Model	Output Power	Spectral Linewidth
403~407 nm	STC-TUN-403~407	1~30 mW	<0.1 nm
408~412 nm	STC-TUN-408~412	1~30 mW	<0.1 nm
448~452 nm	STC-TUN-448~452	1~10 mW	<0.1 nm
518~522 nm	STC-TUN-518~522	1~10 mW	<0.1 nm
634~643 nm	STC-TUN-634~643	1~10 mW	<0.1 nm
652~658 nm	STC-TUN-652~658	1~10 mW	<0.1 nm

◆Tunable Ti:Sapphire Laser

Tunable Wavelength Band	Model	Output Power	Spectral Linewidth
770~840 nm	STC-TUN-TiN-770~840	1~400 mW	<40 pm
770~840 nm	STC-TUN-Ti-770~840	1~1000 mW	<2 nm
770~840 nm	STC-TUN-TiA-770~840	1~1300 mW	<2 nm

◆Tunable Infrared Laser

Tunable Wavelength Band	Model	Output Power	Spectral Linewidth
1400~1800 nm	STC-TUN-W-1400~1800	1~2000 mW	<2 nm
2600~4450 nm	STC-TUN-W-2600~4450	1~1000 mW	<2 nm

Mode-locked & Picosecond Laser Series

Superior beam quality, best reliability, mode-locked & picosecond pulsed laser, pulsed duration could be less than 20ps. Housed in compact packages, are the perfect choice for design in and integration into OEM instrumentation and systems and also for end user applications in research and development.



Applications:

Raman spectroscopy; Marking, Carving; Material processing; Astronomy; Scientific research; Optical instrument

Mode-locked Type:

	Wavelength (nm)	Output power (mW)	Pulse duration (ps)	Rep. rate (MHz)	Operating mode	Transverse mode
STC-PS-R-266	266	1-50	<20	48±1	Mode-locked	TEM ₀₀
STC-PS-R-355	355	1-2000	<20	48±1	Mode-locked	TEM ₀₀
STC-PS-R-532	532	1-3000	<20	48±1	Mode-locked	TEM ₀₀
STC-PS-HR-532	532	1-2 W	~15@500kHz&2 W	100-1000kHz	Mode-locked	TEM ₀₀
STC-PS-RL-1064	1064	1-1000	~15 @10 kHz&1 W	1-10kHz	Mode-locked	TEM ₀₀
STC-PS-HR-1064	1064	1-10 W	~15@500kHz&10W	100-1000kHz	Mode-locked	TEM ₀₀
STC-PS-R-1064	1064	1-10 W	<20	48±1	Mode-locked	TEM ₀₀
STC-PS-Seed-1064	1064	1-300	<20	80±1	Mode-locked	TEM ₀₀
Macro/ Micro-1064-P	1064	10 W	Macro 160 μs	Micro~100MHz	Mode-locked	TEM ₀₀
Macro/ Micro-1319-P	1319	7 W	Macro 160 μs	Micro~100MHz	Mode-locked	TEM ₀₀

Fiber Laser Type:

	Wavelength (nm)	Output power (mW)	Pulse duration (ps)	Rep. rate (MHz)	Operating mode	Transverse mode
STC-FL-266-PS	266	1-10	<10	20-80 (Fixed)	Mode-locked	TEM ₀₀
STC-FL-355-PS	355	1-50	<10	20-80 (Fixed)	Mode-locked	TEM ₀₀
STC-FL-532-PS	532	1-150	<10	20-80 (Fixed)	Mode-locked	TEM ₀₀
STC-FL-1064-PS	1064	1-2000	<10	20-80 (Fixed)	Mode-locked	TEM ₀₀
STC-FL-266-Pico	266	1-50	100-900	0.1-20 (variable)	Pulsed	TEM ₀₀
STC-FL-343-Pico	343	1-50	100-900	0.1-20 (variable)	Pulsed	TEM ₀₀
STC-FL-355-Pico	355	1-50	100-900	0.1-20 (variable)	Pulsed	TEM ₀₀
STC-FL-515-Pico	515	1-1000	100-900	0.1-20 (variable)	Pulsed	TEM ₀₀
STC-FL-532-Pico	532	1-1000	100-900	0.1-80 (variable)	Pulsed	TEM ₀₀
STC-FL-535-Pico	535	1-1000	100-900	0.1-20 (variable)	Pulsed	TEM ₀₀
STC-FL-1030-Pico	1030	10-5000	100-900	0.1-20 (variable)	Pulsed	TEM ₀₀
STC-FL-1064-Pico	1064	10-5000	100-900	0.1-20 (variable)	Pulsed	TEM ₀₀
STC-FL-1070-Pico	1070	10-5000	100-900	0.1-20 (variable)	Pulsed	TEM ₀₀

Diode Pumped Laser Type:

	Wavelength (nm)	Output power (mW)	Pulse duration (ps)	Rep. rate (MHz)	Operating mode	Transverse mode
STC-DPS-213-Pico	213	1-30	<50 ps	5	Pulsed	TEM ₀₀
STC-DPS-266-Pico	266	100-500	<50 ps	5	Pulsed	TEM ₀₀
STC-DPS-355-Pico	355	100-700	<50 ps	5	Pulsed	TEM ₀₀
STC-DPS-532-Pico	532	2-10 W	<50 ps	0.1-10 MHz	Pulsed	TEM ₀₀
STC-DPS-1064-Pico	1064	5-30 W	<50 ps	0.1-10 MHz	Pulsed	TEM ₀₀

Picosecond Pulsed Diode Laser

Picosecond pulsed diode laser features with integrated electronics, narrow pulse duration, high repetition frequency and easy operation. It is widely used



in fluorescence excitation, time resolve spectrum, high sensitive absorption spectroscopy, etc.

Model	Output power	Rep. rate (MHz)	Pulse duration (ps)
STC-MDL-PS-405	10 μ W~0.5 mW	0.1~80	100-1000
STC-MDL-PS-450	10 μ W~0.5 mW	0.1~80	100-1000
STC-MDL-PS-640	50 μ W~3.5 mW	0.1~80	100-1000
STC-MDL-PS-655	20 μ W~1.5 mW	0.1~20	100-1000
STC-MDL-PS-785	70 μ W~4.2 mW	0.1~80	100-1000
STC-MDL-PS-808	90 μ W~6.0 mW	0.1~80	100-1000
STC-MDL-PS-852	10 μ W~1.0 mW	0.1~80	100-1000
STC-MDL-PS-940	20 μ W~1.5 mW	0.1~80	100-1000
STC-MDL-PS-980	20 μ W~1.5 mW	0.1~80	100-1000

STC-FC-D Series Lasers for Raman Spectroscopy

STC-FC-D series fiber coupled laser is specially designed for Raman spectroscopy, wavelength available from 375nm to 980 nm. The spectral linewidth is optional from 0.1 nm and 0.06 nm according to customers' actual requirements. Housed in ultra compact package, it is the perfect choice for Raman spectrometer, chemical and biological research, environmental science, jewelry appraisal, forensic appraisal, food/drug safety inspection, geological exploration, systems design and integration.



Wavelength (nm)	Output power (mW)	Wavelength (nm)	Output power (mW)
375	1~10	690	1~450
405	1~100	730	1~450
445	1~200	785	1~450
488	1~50	808	1~450
514.5	1~30	830	1~100
633	1~50	852	1~450
639	1~200	975	1~450
660	1~200	980	1~450

Note: The model of laser is STC-FC-D-X-Y, X stands for wavelength in nm and Y stands for laser power in mW. When placing the order, please indicate spectral line width (0.1 Or 0.06nm) and power stability (1%, 2% or 3%).

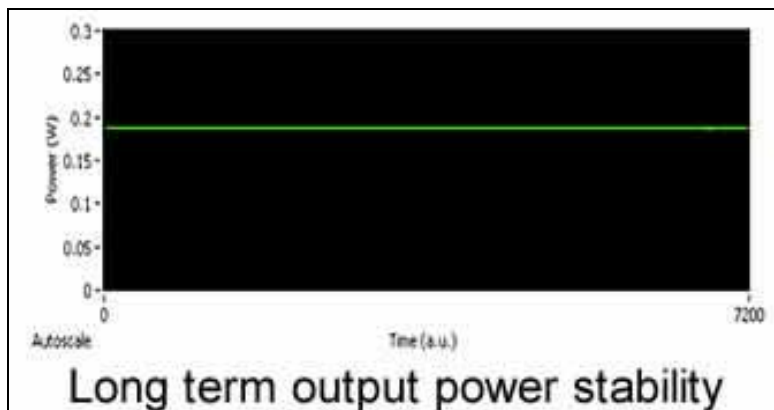
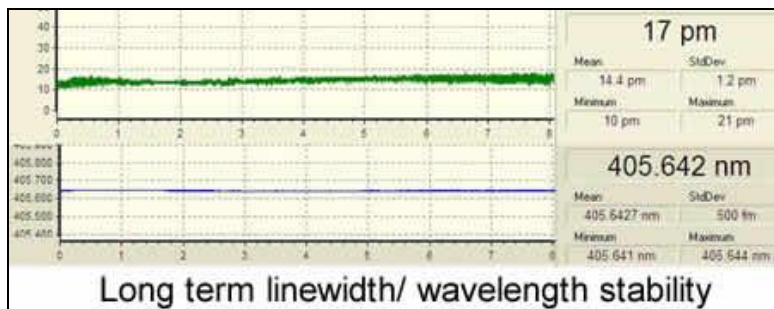

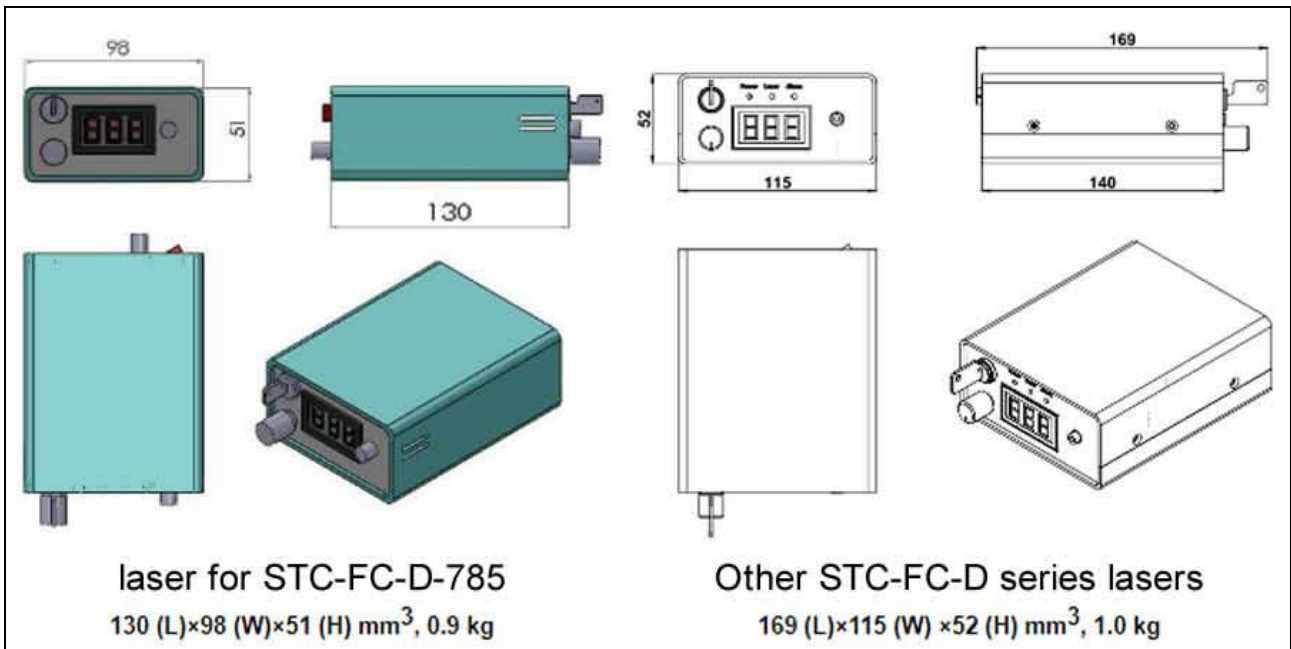
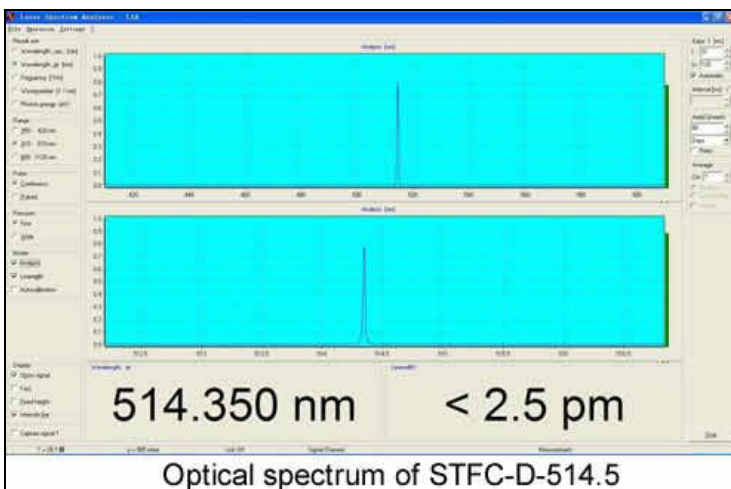
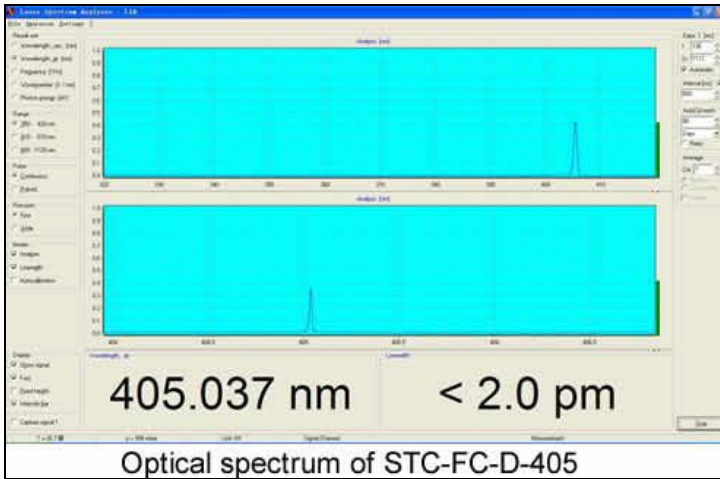

Detailed Specifications

Model	STC-FC-D-375	STC-FC-D-405
Central wavelength (nm)	375±0.5	405±0.5
Spectral line width (nm)	0.1 (0.06, optional)	0.1 (0.06, optional)
Operating mode	CW	CW
Fiber core diameter	100µm, 0.22 NA	100µm, 0.22 NA
Fiber connector	SMA905	SMA905

Output power after fiber (mW)	>1, 2, ..., 10	>1, 10, ..., 100
Power stability (rms, over 4 hours)	<1%, <2%, <3%	<1%, <2%, <3%
Central wavelength stability (rms, over 2 hours) (pm)	<10	<10
Noise of amplitude (rms, 1~20MHz)	<1%	<1%
Warm-up time (minutes)	<5	<5
Operating temperature (°C)	20~30	20~30
Power supply	Adaptor or 5VDC@5A	Adaptor or 5VDC@5A
Expected lifetime (hours)	10000	10000
Warranty	1 year	1 year
Dimension and weight	169x115x52mm, 1.0kg	169x115x52mm, 1.0kg

Model	STC-FC-D-514.5	STC-FC-D-633
Central wavelength (nm)	514.5±0.5	633±0.5
Spectral line width (nm)	0.1 (0.06, optional)	0.1 (0.06, optional)
Operating mode	CW	CW
Fiber core diameter	100µm, 0.22 NA	100µm, 0.22 NA
Fiber connector	SMA905	SMA905
Output power after fiber (mW)	>1, 2, ..., 30	>1, 10, ..., 50
Power stability (rms, over 4 hours)	<1%, <2%, <3%	<1%, <2%, <3%
Central wavelength stability (rms, over 2 hours) (pm)	<10	<10
Noise of amplitude (rms, 1~20MHz)	<1%	<1%
Warm-up time (minutes)	<5	<5
Operating temperature (°C)	20~30	20~30
Power supply	Adaptor or 5VDC@5A	Adaptor or 5VDC@5A
Expected lifetime (hours)	10000	10000
Warranty	1 year	1 year
Dimension and weight	169x115x52mm, 1.0kg	169x115x52mm, 1.0kg

Model	STC-FC-D-808	STC-FC-D-852
Central wavelength (nm)	808±0.5	852±0.5
Spectral line width (nm)	0.1 (0.06, optional)	0.1 (0.06, optional)
Operating mode	CW	CW
Fiber core diameter	100µm, 0.22 NA	100µm, 0.22 NA
Fiber connector	SMA905	SMA905
Output power after fiber (mW)	>1, 100, ..., 450	>1, 100, ..., 450
Power stability (rms, over 4 hours)	<1%, <2%, <3%	<1%, <2%, <3%
Central wavelength stability (rms, over 2 hours) (pm)	<10	<10
Noise of amplitude (rms, 1~20MHz)	<1%	<1%
Warm-up time (minutes)	<5	<5
Operating temperature (°C)	20~30	20~30
Power supply	Adaptor or 5VDC@5A	Adaptor or 5VDC@5A
Expected lifetime (hours)	10000	10000
Warranty	1 year	1 year
Dimension and weight	169x115x52mm, 1.0kg	169x115x52mm, 1.0kg